

# Operating Instructions Memograph M, RSG45

## Advanced Data Manager





## Table of contents

<b>1</b>	<b>About this document</b>	<b>6</b>		
1.1	Document function	6		
1.2	Symbols	6		
1.2.1	Safety symbols	6		
1.2.2	Electrical symbols	6		
1.2.3	Symbols for certain types of information	7		
1.2.4	Symbols in graphics	7		
1.3	Terminology	7		
1.4	Registered trademarks	8		
<b>2</b>	<b>Basic safety instructions</b>	<b>8</b>		
2.1	Requirements concerning the staff	8		
2.2	Intended use	9		
2.3	Workplace safety	9		
2.4	Operational safety	9		
2.5	Product safety	9		
2.6	Safety information for desktop version (option)	10		
2.7	IT security	10		
<b>3</b>	<b>Product description</b>	<b>10</b>		
3.1	Product design	10		
<b>4</b>	<b>Incoming acceptance and product identification</b>	<b>10</b>		
4.1	Incoming acceptance	10		
4.2	Scope of delivery	10		
4.3	Product identification	11		
4.3.1	Nameplate	11		
4.3.2	Name and address of manufacturer	11		
4.4	Storage and transport	11		
<b>5</b>	<b>Mounting</b>	<b>12</b>		
5.1	Mounting requirements	12		
5.1.1	Installation dimensions for the panel-mounted device	12		
5.1.2	Mounting location and installation dimensions for the DIN rail version	12		
5.2	Mounting the measuring device	14		
5.2.1	Mounting the panel-mounted device	14		
5.2.2	Mounting and disassembling the DIN rail version	15		
5.3	Post-mounting check	16		
<b>6</b>	<b>Electrical connection</b>	<b>16</b>		
6.1	Connecting requirements	16		
6.2	Connecting instructions	17		
6.2.1	Cable specification	17		
6.3	Connecting the measuring device	17		
6.3.1	Connections	17		
6.3.2	Electrical connection, terminal assignment	18		
6.3.3	Connection example: Auxiliary voltage output as transmitter power supply for 2-wire sensors	23		
6.3.4	Connection example: Auxiliary voltage output as transmitter power supply for 4-wire sensors	24		
6.3.5	Connection example: HART® input in a point-to-point connection	25		
6.3.6	Connection example: HART® input in a Multidrop connection	25		
6.3.7	RS232/RS485 interface (CPU card, slot 0)	26		
6.3.8	Ethernet connection (CPU card, slot 0)	27		
6.3.9	Option: Anybus® interface (CPU card, slot 0)	28		
6.3.10	USB connection, type A (host) (CPU card, slot 0)	28		
6.3.11	Front of device (version with navigator and front interfaces)	29		
6.3.12	General information on USB devices	29		
6.4	Post-connection check	31		
<b>7</b>	<b>Operation options</b>	<b>32</b>		
7.1	Overview of operation options	32		
7.2	Structure and function of the operating menu	32		
7.2.1	Operating menu for operators and maintenance personnel	33		
7.2.2	Operating menu for experts	34		
7.2.3	Submenus and users	34		
7.3	Measured value display and operating elements	36		
7.3.1	Measured value display and operating elements on panel- mounted device	36		
7.3.2	Operating elements of the DIN rail version	37		
7.4	Display representation of symbols used in operation	38		
7.4.1	Symbols in operating menus	39		
7.4.2	Symbols in the event logbook	40		
7.5	Entering text and numbers (virtual keyboard)	40		
7.6	Channel color assignment	40		
7.7	Access to the operating menu via the local display	41		
7.8	Device access via operating tools	41		
7.8.1	Field Data Manager (FDM) analysis software (SQL database support)	41		
7.8.2	Web server	41		
7.8.3	OPC server (optional)	41		

7.8.4	FieldCare/DeviceCare configuration software .....	42	11.4	Web server .....	64
<b>8</b>	<b>System integration .....</b>	<b>43</b>	11.4.1	Access to the Web server via HTTP (HTML) .....	64
8.1	Integrating the measuring device in the system .....	43	11.4.2	Access to the Web server via XML ...	65
8.1.1	General notes .....	43	11.4.3	Setup, operation and service via the Web server .....	65
8.1.2	Ethernet .....	43	11.4.4	Remote control via the Web server ...	69
8.1.3	Web server with "Ethernet over USB" function .....	43	11.5	Changing the group .....	69
8.1.4	Modbus RTU/TCP slave .....	45	11.6	Locking operation .....	69
<b>9</b>	<b>Commissioning .....</b>	<b>45</b>	11.7	Login / logout .....	70
9.1	Function check .....	45	11.8	Changing the password .....	70
9.2	Switching on the measuring device .....	46	11.9	SD card/USB stick .....	70
9.3	Setting the operating language .....	46	11.9.1	Function of SD card or USB stick ...	70
9.4	Configuring the measuring device (Setup menu) .....	46	11.9.2	DIN rail version: function of SD card or USB stick .....	71
9.4.1	Step-by-step: to the first measured value .....	47	11.9.3	Functions relating to the SD card or USB stick .....	71
9.4.2	Step-by-step: set or delete the limit values .....	47	11.9.4	Notes on e-mail encryption .....	74
9.4.3	Step-by-step: read HART® values (option) .....	48	11.9.5	Notes on WebDAV encryption .....	75
9.4.4	Step-by-step: HART® communication between an FDT Frame application (FieldCare) and a HART® device/sensor (optional) .....	48	11.9.6	SSL certificates .....	75
9.4.5	Device setup .....	49	11.10	Show data logging .....	76
9.4.6	Setup via SD card or USB stick .....	49	11.10.1	Historical data: changing a group ...	76
9.4.7	Setup via Web server .....	49	11.10.2	Historical data: Scroll speed .....	77
9.4.8	Setup via FieldCare/DeviceCare configuration software .....	52	11.10.3	Historical data: Time scaling .....	77
9.5	Advanced settings (Expert menu) .....	52	11.10.4	Historical data: Time range displayed .....	77
9.6	Configuration management .....	53	11.10.5	Historical data: Screenshot .....	77
9.7	Simulation .....	53	11.10.6	Historical data: Change the display mode .....	77
9.8	Access protection and security concept .....	54	11.10.7	Historical data: Store text .....	77
9.9	HTTPS Web server setup .....	55	11.11	Signal analysis .....	77
9.10	TrustSens Calibration Monitoring .....	57	11.12	Search in trace .....	78
<b>10</b>	<b>Fulfilling requirements in accordance with "FDA 21 CFR Part 11" .....</b>	<b>58</b>	11.13	Changing the display mode .....	78
10.1	General notes .....	58	11.14	Store text .....	78
10.2	Important device settings .....	60	11.15	Printout .....	78
10.3	Important settings in the Field Data Manager (FDM) PC software .....	61	11.16	Adjusting the brightness of the display .....	79
<b>11</b>	<b>Operation .....</b>	<b>62</b>	11.17	Limit values .....	79
11.1	Reading-out and changing the Ethernet setting address .....	62	11.18	WebDAV client .....	79
11.2	Reading off the device locking status .....	62	11.18.1	Access to the WebDAV server via HTTP (HTML) .....	79
11.3	Reading off measured values (display devices) .....	63	11.19	Data analysis and visualization with the Field Data Manager software (FDM) provided .....	80
			11.19.1	Structure/layout of a CSV file .....	80
			11.19.2	Importing UTF-8-encoded CSV files into spreadsheets .....	81
			<b>12</b>	<b>Diagnostics and troubleshooting ...</b>	<b>82</b>
			12.1	General troubleshooting .....	82
			12.2	Troubleshooting .....	82
			12.2.1	Device error/alarm relay .....	82
			12.3	Diagnostic information on the local display ...	83
			12.4	Pending, current diagnostic messages .....	88
			12.5	Diagnosis list .....	88
			12.6	Event logbook .....	88
			12.7	Device information .....	88
			12.8	Diagnostics of measured values .....	89
			12.9	Diagnostics of outputs .....	89

12.10 Simulation . . . . .	89	17.1.5 "Application" submenu . . . . .	213
12.10.1 Test barcode reader . . . . .	89	17.1.6 "Diagnostics" submenu . . . . .	270
12.10.2 E-mail test . . . . .	89		
12.10.3 Test WebDAV client . . . . .	89		
12.10.4 Test telealarm . . . . .	89		
12.10.5 Test time synchronization/SNTP . . . . .	90		
12.10.6 Test universal output . . . . .	90		
12.10.7 Relay test . . . . .	90		
12.11 HART® diagnostics . . . . .	90		
12.12 PROFINET diagnostics (option) . . . . .	90		
12.13 Diagnostics EtherNet/IP (option) . . . . .	90		
12.14 Initializing the modem . . . . .	90		
12.15 GSM terminal . . . . .	91		
12.16 Status telealarm . . . . .	91		
12.17 Resetting the measuring device . . . . .	91		
12.18 Clear memory . . . . .	91		
12.19 Reset analysis . . . . .	91		
12.20 Firmware history . . . . .	91		
<b>13 Maintenance . . . . .</b>	<b>92</b>		
13.1 Updating the device software ("firmware") . . . . .	92		
13.2 Instructions for enabling a software option . . . . .	92		
13.3 Cleaning . . . . .	92		
<b>14 Repair . . . . .</b>	<b>93</b>		
14.1 General notes . . . . .	93		
14.2 Spare parts . . . . .	93		
14.3 Return . . . . .	95		
14.4 Disposal . . . . .	95		
14.4.1 IT security . . . . .	95		
14.4.2 Removing the measuring device . . . . .	96		
14.4.3 Disposing of the measuring device . . . . .	96		
<b>15 Accessories . . . . .</b>	<b>97</b>		
15.1 Device-specific accessories . . . . .	97		
<b>16 Technical data . . . . .</b>	<b>100</b>		
16.1 Function and system design . . . . .	100		
16.2 Input . . . . .	103		
16.3 Output . . . . .	108		
16.4 Power supply . . . . .	110		
16.5 Performance characteristics . . . . .	119		
16.6 Mounting . . . . .	119		
16.7 Environment . . . . .	122		
16.8 Mechanical construction . . . . .	122		
16.9 Display and operating elements . . . . .	124		
16.10 Certificates and approvals . . . . .	128		
16.11 Ordering information . . . . .	128		
16.12 Supplementary documentation . . . . .	129		
<b>17 Appendix . . . . .</b>	<b>130</b>		
17.1 Operating items in the "Expert" menu . . . . .	130		
17.1.1 "System" submenu . . . . .	130		
17.1.2 "Inputs" submenu . . . . .	152		
17.1.3 "Outputs" submenu . . . . .	183		
17.1.4 "Communication" submenu . . . . .	189		
		<b>Index . . . . .</b>	<b>275</b>

# 1 About this document

## 1.1 Document function

These Operating Instructions contain all the information that is required in the various phases of the device's life cycle: from product identification, incoming acceptance and storage, to mounting, connection, operation fundamentals and commissioning through to troubleshooting, maintenance and disposal.

### Integrated Operating Instructions

At the push of a button, the device displays operating instructions directly on the screen. This manual complements the operating instructions in the device and explains what is not directly described in the operating instructions.

## 1.2 Symbols

### 1.2.1 Safety symbols

#### DANGER

This symbol alerts you to a dangerous situation. Failure to avoid this situation will result in serious or fatal injury.

#### WARNING

This symbol alerts you to a dangerous situation. Failure to avoid this situation can result in serious or fatal injury.





#### CAUTION

This symbol alerts you to a dangerous situation. Failure to avoid this situation can result in minor or medium injury.











#### NOTICE

This symbol contains information on procedures and other facts which do not result in personal injury.



### 1.2.2 Electrical symbols

Symbol	Meaning
	Direct current
	Alternating current
	Direct current and alternating current
	<b>Ground connection</b> A grounded terminal which, as far as the operator is concerned, is grounded via a grounding system.
	<b>Protective Earth (PE)</b> A terminal which must be connected to ground prior to establishing any other connections.  The ground terminals are situated inside and outside the device: <ul style="list-style-type: none"> <li>▪ Inner ground terminal: Connects the protective earth to the mains supply.</li> <li>▪ Outer ground terminal: Connects the device to the plant grounding system.</li> </ul>

### 1.2.3 Symbols for certain types of information

Symbol	Meaning
	<b>Permitted</b> Procedures, processes or actions that are permitted.
	<b>Preferred</b> Procedures, processes or actions that are preferred.
	<b>Forbidden</b> Procedures, processes or actions that are forbidden.
	<b>Tip</b> Indicates additional information.
	Reference to documentation
	Reference to page
	Reference to graphic
	Notice or individual step to be observed
<b>1, 2, 3...</b>	Series of steps
	Result of a step
	Help in the event of a problem
	Visual inspection

### 1.2.4 Symbols in graphics

Symbol	Meaning
<b>1, 2, 3,...</b>	Item numbers
<b>1. , 2. , 3. ...</b>	Series of steps
<b>A, B, C, ...</b>	Views
<b>A-A, B-B, C-C, ...</b>	Sections
 A0013441	Flow direction
 A0011187	<b>Hazardous area</b> Indicates a hazardous area.
 A0011188	<b>Safe area (non-hazardous area)</b> Indicates a non-hazardous area.

## 1.3 Terminology

To improve clarity, abbreviations or synonyms are used in these instructions for the following terms:

- Endress+Hauser:  
Term used in these instructions: "Manufacturer" or "Supplier"
- Memograph M RSG45:  
Term used in these instructions: "Device" or "Measuring device"

## 1.4 Registered trademarks

### **HART®**

Registered trademark of the HART FieldComm Group, Austin, USA

### **PROFIBUS®**

Registered trademark of the PROFIBUS Nutzerorganisation e.V. (PROFIBUS User Organization), Karlsruhe, Germany

### **PROFINET®**

Registered trademark of PROFIBUS & PROFINET International, Karlsruhe, Germany

### **Modbus®**

Registered trademark of SCHNEIDER AUTOMATION, INC.

### **EtherNet/IP™**

Registered trademark of ODVA, INC.

### **Internet Explorer®, Excel™**

Registered trademarks of the Microsoft Corporation

### **Mozilla Firefox®**

Registered trademark of Mozilla Foundation

### **Opera®**

Registered trademark of Opera Software ASA.

### **Google Chrome™**

Registered trademark of Google INC.

## 2 Basic safety instructions

Reliable and safe operation of the device is guaranteed only if the user reads these Operating Instructions and complies with the safety instructions they contain.

### **Requirements concerning operating staff to ensure compliance with FDA 21 CFR Part 11:**

In order to fully comply with the requirements of 21 CFR Part 11, the operators/users must be properly trained.

### 2.1 Requirements concerning the staff

The personnel for installation, commissioning, diagnostics and maintenance must fulfill the following requirements:

- ▶ Trained, qualified specialists: must have a relevant qualification for this specific function and task
- ▶ Are authorized by the plant owner/operator
- ▶ Are familiar with federal/national regulations
- ▶ Before beginning work, the specialist staff must have read and understood the instructions in the Operating Instructions and supplementary documentation as well as in the certificates (depending on the application)
- ▶ Following instructions and basic conditions

The operating personnel must fulfill the following requirements:

- ▶ Being instructed and authorized according to the requirements of the task by the facility's owner-operator
- ▶ Following the instructions in these Operating Instructions



## 2.2 Intended use

This device is intended for the electronic capture, display, recording, analysis, remote transmission and archiving of analog and digital input signals.

- The manufacturer accepts no liability for damages resulting from incorrect use or use other than that designated. It is not permitted to convert or modify the device in any way.
- The device is designed for installation in a panel and must only be operated in an installed state.

## 2.3 Workplace safety

For work on and with the device:

- ▶ Wear the required personal protective equipment according to national regulations.

If working on and with the device with wet hands:

- ▶ Due to the increased risk of electric shock, wear suitable gloves.

## 2.4 Operational safety

Risk of injury!

- ▶ Operate the device only if it is in proper technical condition, free from errors and faults.
- ▶ The operator is responsible for interference-free operation of the device.

### Modifications to the device

Unauthorized modifications to the device are not permitted and can lead to unforeseeable dangers:

- ▶ If modifications are nevertheless required, consult with the manufacturer.

### Repair

To ensure continued operational safety and reliability:

- ▶ Carry out repairs on the device only if they are expressly permitted.
- ▶ Observe federal/national regulations pertaining to the repair of an electrical device.
- ▶ Use only original spare parts and accessories from the manufacturer.

### Hazardous area

To eliminate danger to persons or the facility when the device is used in the hazardous area (e.g. explosion protection):

- ▶ Check the nameplate to verify if the device ordered can be put to its intended use in the hazardous area.
- ▶ Observe the specifications in the separate supplementary documentation that is an integral part of these instructions.

## 2.5 Product safety

This measuring device is designed in accordance with good engineering practice to meet state-of-the-art safety requirements, has been tested, and left the factory in a condition in which it is safe to operate.

It meets general safety standards and legal requirements. It also complies with the EC directives listed in the device-specific EC Declaration of Conformity. The manufacturer confirms this by affixing the CE mark to the device.

## 2.6 Safety information for desktop version (option)

- The mains plug should only be inserted into a socket with a ground contact.
- The protective effect may not be suspended by an extension cable without a protective ground.
- Relay outputs:  $U (\text{max}) = 30 V_{\text{eff}} (\text{AC}) / 60 \text{ V (DC)}$

## 2.7 IT security

The manufacturer only provides a warranty if the device is installed and used as described in the Operating Instructions. The device is equipped with security mechanisms to protect it against any inadvertent changes to the device settings.

IT security measures in line with operators' security standards and designed to provide additional protection for the device and device data transfer must be implemented by the operators themselves.

# 3 Product description

## 3.1 Product design

This device is best suited for the electronic acquisition, display, recording, analysis, remote transmission and archiving of analog and digital input signals.

The device is intended for installation in a panel or cabinet. Operation in a desktop or field housing is possible as an option.

In addition, the "DIN rail" housing option is available for DIN rail mounting.

# 4 Incoming acceptance and product identification

## 4.1 Incoming acceptance

On receipt of the goods, check the following points:

- Is the packaging or the content damaged?
- Is the delivery complete? Compare the scope of delivery against the information on your order form.

## 4.2 Scope of delivery

The scope of delivery of the device comprises:

- Device (with terminals, as per order)
- Panel-mounted device: 2 screw fastening clips
- Version with navigator and front interfaces or DIN rail version: USB cable
- Panel-mounted device: sealing rubber towards the panel wall
- "Industrial Grade" SD card, industry standard:
  - Panel-mounted device with navigator and front interfaces: card is located in the SD slot behind the flap on the front of the device (optional).
  - Panel-mounted device with stainless steel front and touchscreen: card is located in the device and cannot be replaced or retrofitted.
  - DIN rail version: card is located in the SD slot (optional).

- "Field Data Manager (FDM)" analysis software on DVD (Essential, Demo or Professional version, depending on order)
- Delivery note
- Multilanguage Brief Operating Instructions, hard copy
- Ex Safety Instructions, hard copy (optional)

### 4.3 Product identification

#### 4.3.1 Nameplate

Compare the nameplate with the following diagram:

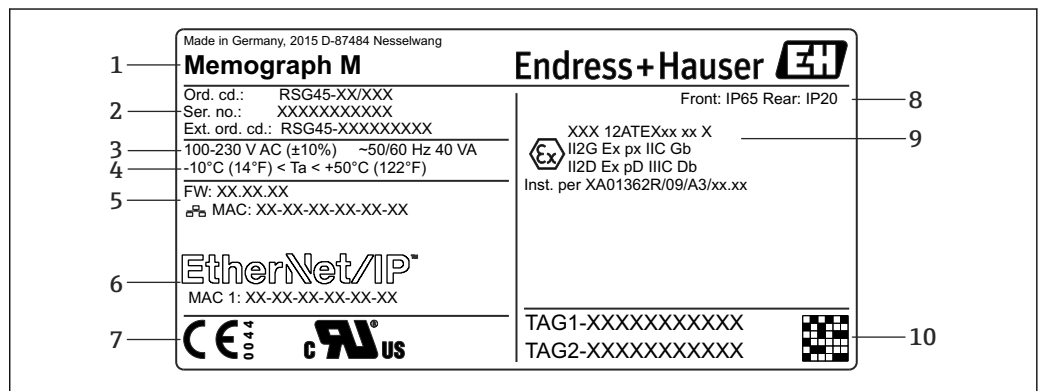

1 Device nameplate (example)

- 1 Device designation, manufacturer details
- 2 Order code, serial number, extended order code
- 3 Power supply, mains frequency and maximum power consumption
- 4 Ambient temperature range
- 5 Firmware version; MAC address (Ethernet)
- 6 Fieldbus interface with MAC address (optional)
- 7 Device approvals
- 8 Degree of protection of the device
- 9 Approval in hazardous area (optional) with number of the relevant Ex documentation (XA...)
- 10 TAG name (optional); 2D-matrix code

#### 4.3.2 Name and address of manufacturer

<b>Name of manufacturer:</b>	Endress+Hauser Wetzler GmbH + Co. KG
<b>Address of manufacturer:</b>	Obere Wank 1, D-87484 Nesselwang
<b>Model/type reference:</b>	RSG45

### 4.4 Storage and transport

Compliance with the permitted environmental and storage conditions is mandatory. Precise specifications are provided in the "Technical data" section.

Please note the following:

- Pack the device so that is protected against impact for storage and transport. The original packaging provides optimum protection.
- The permitted storage temperature is -20 to +60 °C (-4 to +140 °F)

## 5 Mounting

### 5.1 Mounting requirements

#### NOTICE

#### Overheating due to buildup of heat in the device

- ▶ To avoid heat buildup, always ensure that the device is sufficiently cooled.

The device is designed for use in a panel or in the control cabinet.

 The device must be installed in a pressurized enclosure system for operation in the hazardous area. To ensure safe installation, it is essential to follow the installation instructions for the cabinet and the installation instructions in the Ex-related Safety Instructions (XA).

- Ambient temperature range: -10 to +50 °C (14 to 122 °F)
- Climate class as per IEC 60654-1: Class B2
- Degree of protection: IP65, NEMA 4 at front / IP20 rear of housing

#### 5.1.1 Installation dimensions for the panel-mounted device

- Installation depth (excluding terminal cover): approx. 159 mm (6.26 in) for device incl. terminals and fastening clips.
- Installation depth including terminal cover (option): approx. 198 mm (7.8 in)
- Panel cutout: 138 to 139 mm (5.43 to 5.47 in) x 138 to 139 mm (5.43 to 5.47 in)
- Panel thickness: 2 to 40 mm (0.08 to 1.58 in)
- viewing angle range: 50° in all directions from the display central axis
- A minimum distance of 12 mm (0.47 in) between the devices must be observed if aligning the devices vertically above one another or horizontally beside one another.
- The grid dimension of the panel cutouts for multiple devices must be at least 208 mm (8.19 in) horizontally and at least 162 mm (6.38 in) vertically (tolerance not considered).
- Securing to DIN 43 834

#### 5.1.2 Mounting location and installation dimensions for the DIN rail version

The device without a display is designed for DIN rail mounting.

 The DIN rail device is **not** approved for operation in the hazardous area.

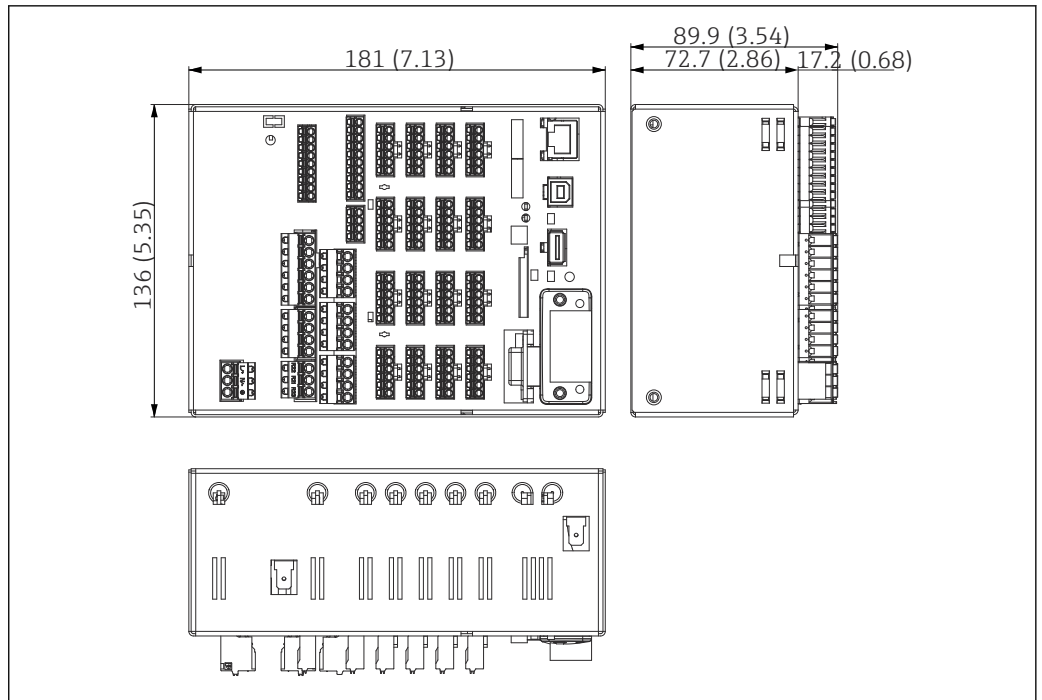

A0036528

2 DIN rail version, dimensions in mm (in)

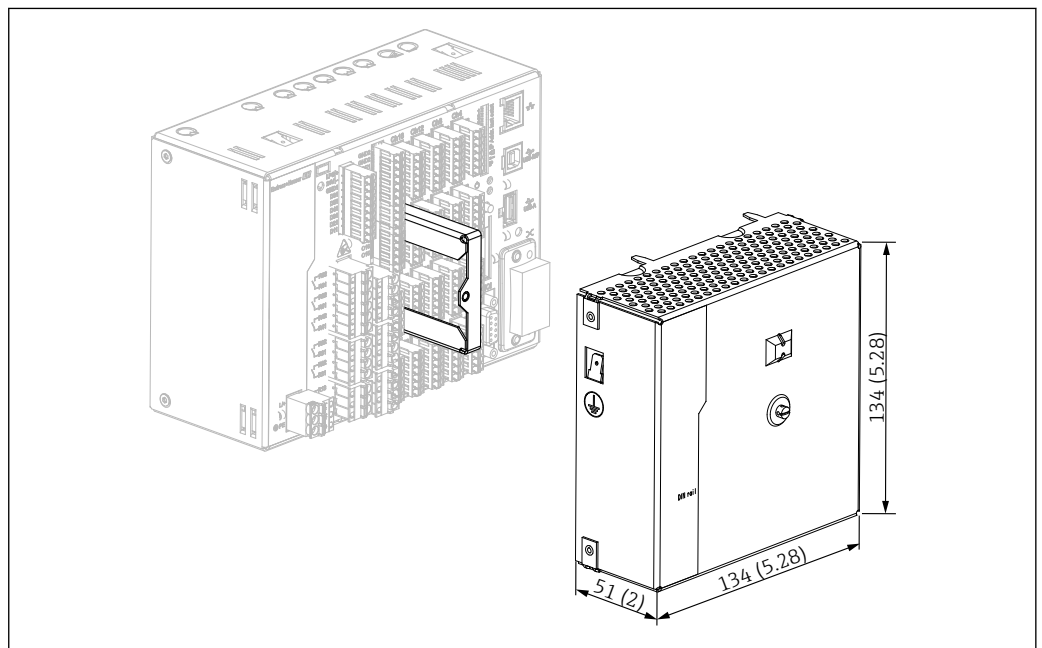

A0046633

3 Terminal cover, DIN rail version, dimensions in mm (in)

### Dimensions

- Installation depth: approx. 90 mm (3.54 in) for device incl. terminals (w/o terminal cover).
- Mounted on DIN rail as per IEC 60715
- The devices can be arranged horizontally beside one another without clearance between the devices.

## 5.2 Mounting the measuring device

### 5.2.1 Mounting the panel-mounted device

**i** Mounting tool: For installation in the panel, all you need is a screwdriver.

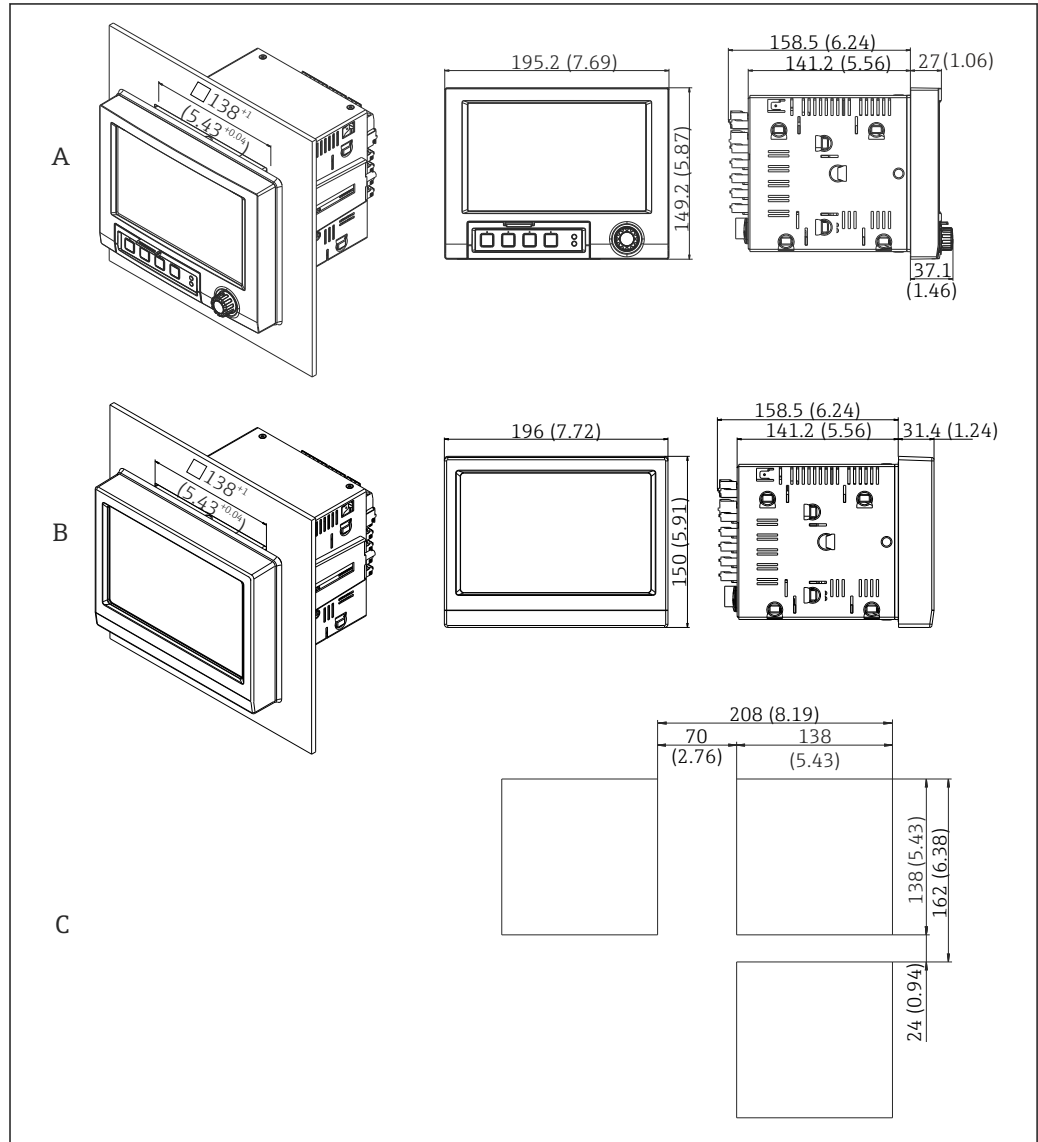

A0024610

**4** Panel cutout and dimensions in mm (in).

- A Version with navigator and front interfaces
- B Version with stainless steel front and touchscreen
- C Grid dimensions of panel cutouts for multiple devices

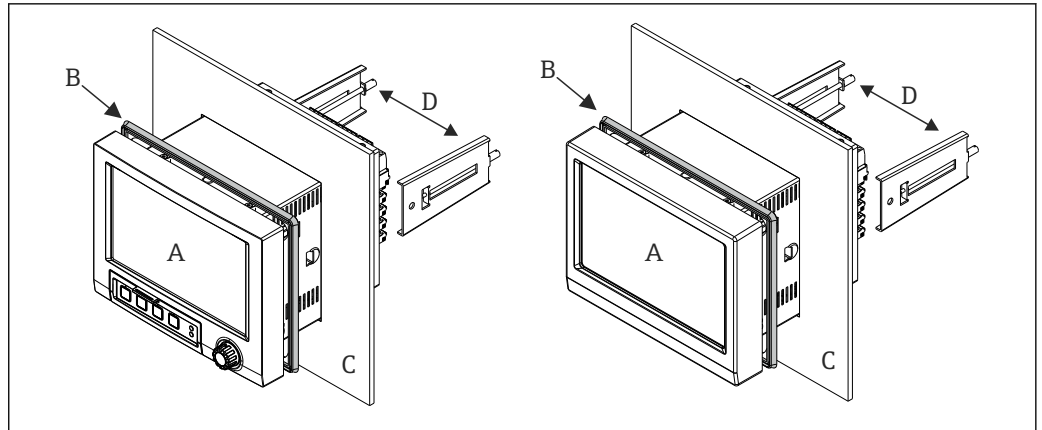

A0026672

5 Panel mounting

1. From the rear of the device, push the sealing rubber (B) (supplied) as far as the front frame of the device (A).
2. Slide the device (A) through the panel cutout from the front (C). To avoid the buildup of heat, maintain a distance of >12 mm (>0.47 in) from walls and other devices.
3. Hold the device (A) level and hook the fastening clips (D) into the openings (1 x left, 1 x right).
4. Evenly tighten the screws on the fastening clips (D) using a screwdriver to guarantee a secure seal to the panel (torque: 100 Ncm).

### 5.2.2 Mounting and disassembling the DIN rail version

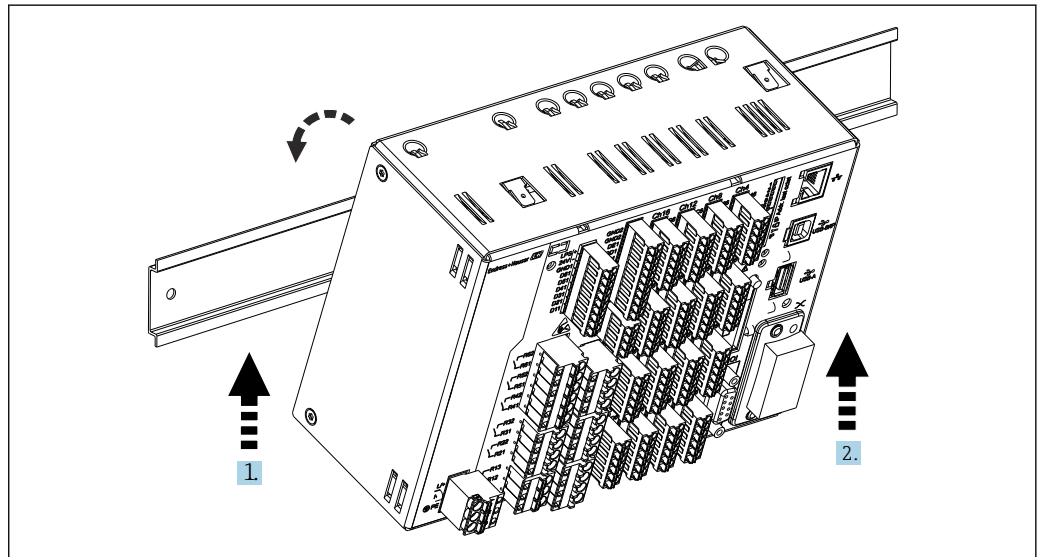

A0036761

6 DIN rail version

1. Set the device on the top-hat rail from below.
  2. Swivel the device into the end position by pushing the device gently upwards and turning it towards the carrier rail.
  3. Lower the device gently to release it. The device is now engaged on the DIN rail.
- Disassembly is the reverse of the assembly sequence.

## 5.3 Post-mounting check

Panel-mounted device:

- Is the sealing ring undamaged?
- Does the seal run all around the housing collar?
- Are the fastening clips tightened?
- Is the device firmly seated in the center of the panel cutout?

DIN rail version:

Check that the device is firmly seated on the DIN rail

# 6 Electrical connection

## 6.1 Connecting requirements

### WARNING

**Danger! Electric voltage!**

- ▶ The entire connection of the device must take place while the device is de-energized.
- ▶ The mixed connection of safety extra-low voltage and dangerous contact voltage to the relay is **not** permitted.
- ▶ Apart from the relays and the supply voltage, only energy-limited circuits according to IEC/EN 61010-1 may be connected.

Danger if protective ground is disconnected

- ▶ The ground connection must be made before all other connections.

### NOTICE

**Cable heat load**

- ▶ Use suitable cables for temperatures of 5 °C (9 °F) above ambient temperature.

Incorrect supply voltage can damage the device or cause malfunctions

- ▶ Before commissioning the device, make sure that the supply voltage matches the voltage specifications on the nameplate.

Check emergency shutdown for device

- ▶ Provide suitable switch or circuit breaker in building installation. This switch must be provided close to the device (within easy reach) and marked as a circuit breaker.

Protect the device from overload

- ▶ Provide overload protection (nominal current = 10 A) for power cable.

Incorrect wiring may result in the device being destroyed

- ▶ Note terminal designation on the rear of the device.

Energy-rich transients in the case of long signal lines

- ▶ Install suitable overvoltage protection (e.g. E+H HAW562) upstream.

### Special requirements according to FDA 21 CFR Part 11:

- The user must have the appropriate skills and qualifications to connect the device. Connection errors can only be prevented in this way.
- The user is responsible for selecting the right input ranges and for connecting suitable sensors.
- Users must ensure that the connected sensors cannot be tampered with by making sure they are suitably mounted and wired.
- An optional terminal cover is available to prevent tampering at the device terminals and terminal temperature measurement. It is the responsibility of the user to verify that the device is correctly installed and sealed following validation.
- The user is responsible for compliance with the EMC limit values at the installation location (see technical data).



## 6.2 Connecting instructions

### 6.2.1 Cable specification

#### Cable specification, spring terminals

All connections on the rear of the device are designed as pluggable screw or spring terminal blocks with reverse polarity protection. This makes the connection very quick and easy. The spring terminals are unlocked with a slotted screwdriver (size 0).

Please note the following when connecting:

- Wire cross-section, auxiliary voltage output, digital I/O and analog I/O: max. 1.5 mm<sup>2</sup> (14 AWG) (spring terminals)
- Wire cross-section, mains: max. 2.5 mm<sup>2</sup> (13 AWG) (screw terminals)
- Wire cross-section, relays: max. 2.5 mm<sup>2</sup> (13 AWG) (spring terminals)
- Stripping length: 10 mm (0.39 in)

 No ferrules must be used when connecting flexible wires to spring terminals.

#### Shielding and grounding

Optimum electromagnetic compatibility (EMC) can only be guaranteed if the system components and, in particular, the lines - both sensor lines and communication lines - are shielded and the shield forms as complete a cover as possible. A shielded line must be used for sensor lines that are longer than 30 m. A shield coverage of 90% is ideal. In addition, make sure not to cross sensor lines and communication lines when routing them. Connect the shield as often as possible to the reference ground to ensure optimum EMC protection for the different communication protocols and the connected sensors.

To comply with requirements, three different types of shielding are possible:

- Shielding at both ends
- Shielding at one end on the supply side with capacitance termination at the device
- Shielding at one end on the supply side

Experience shows that the best results with regard to EMC are achieved in most cases in installations with one-sided shielding on the supply side (without capacitance termination at the device). Appropriate internal device wiring measures must be taken to allow unrestricted operation when EMC interference is present. These measures have been taken into account for this device. Operation in the event of disturbance variables as per NAMUR NE21 is thus guaranteed.

Where applicable, national installation regulations and guidelines must be observed during the installation! Where there are large differences in potential between the individual grounding points, only one point of the shielding is connected directly with the reference ground.

 If the shielding of the cable is grounded at more than one point in systems without potential matching, mains frequency equalizing currents can occur. These can damage the signal cable or significantly impact signal transmission. In such cases the shielding of the signal cable is to be grounded on one side only, i.e. it may not be connected to the ground terminal of the housing. The shield that is not connected should be insulated!

## 6.3 Connecting the measuring device

### 6.3.1 Connections

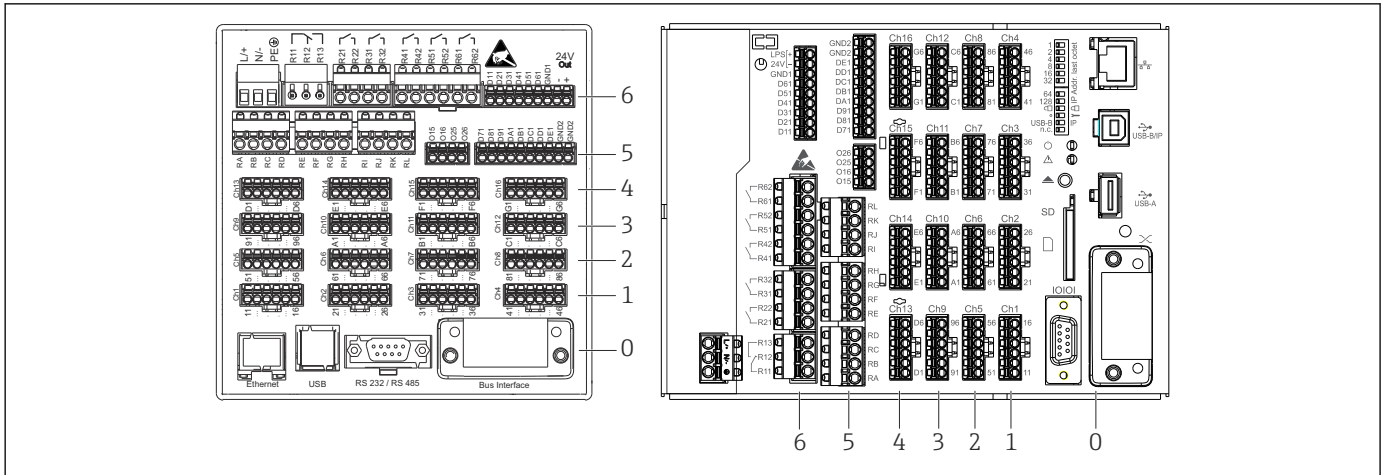

A0024605

**7** Connections: back of device, panel version (left), DIN rail version (right)

- 6 Slot 6: Power supply with relays
- 5 Slot 5: Multifunction card or HART® card (channels 17-20) or digital card
- 4 Slot 4: Multifunction card or HART® card (channels 13-16)
- 3 Slot 3: Multifunction card or HART® card (channels 9-12)
- 2 Slot 2: Multifunction card or HART® card (channels 5-8)
- 1 Slot 1: Multifunction card or HART® card (channels 1-4)
- 0 Slot 0: CPU card with interfaces

### 6.3.2 Electrical connection, terminal assignment

**i** All connection examples are illustrated using the panel version. The connections on the DIN rail version are identical.

Circuit diagram

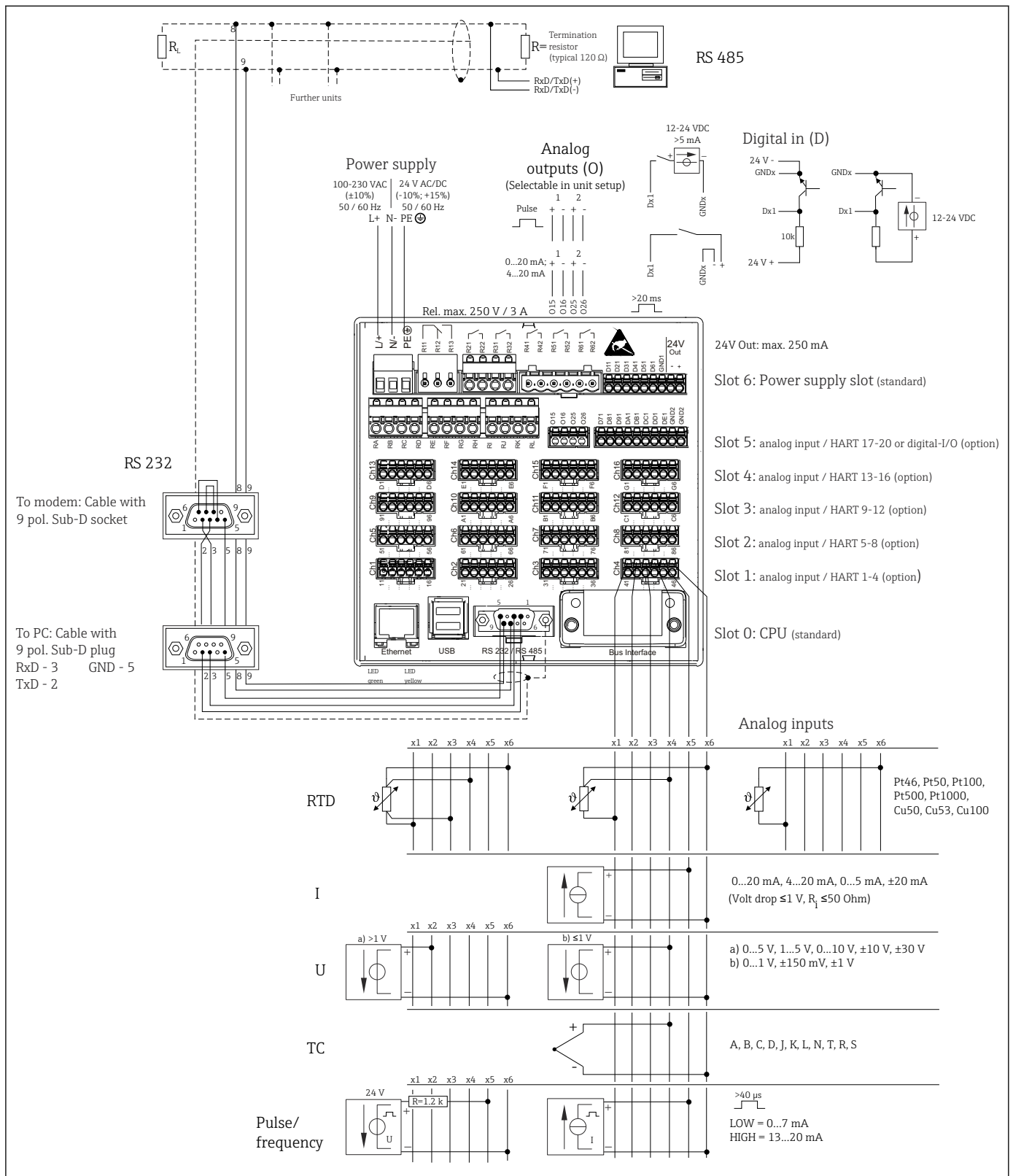

8 For connection examples of the HART® inputs (optional), see the Operating Instructions → 25

Supply voltage (power unit, slot 6)

Power unit type	Terminal		
100-230 VAC	L+	N-	PE
	Phase L	Zero conductor N	Ground
24 V AC/DC	L+	N-	PE
	Phase L or +	Zero conductor N or -	Ground

Relay (power unit, slot 6)

Type	Terminal (max. 250 V, 3 A)				
Alarm relay 1	R11	R12	R13		
	Changeover contact	Normally closed contact (NC) <sup>1)</sup>	Normally open contact (NO) <sup>2)</sup>		
Relay 2 to 6				Rx1	Rx2
				Switching contact	Normally open contact (NO) <sup>2)</sup>

- 1) NC = normally closed (breaker)
- 2) NO = normally open (maker)

**i** The open or close function (= activation or deactivation of the relay coil) in a limit event can be configured in the setup: "Setup -> Advanced setup -> Outputs -> Relay -> Relay x". However, in the event of a power failure, the relay adopts its quiescent switch state regardless of the setting programmed.

Digital inputs; auxiliary voltage output (power unit, slot 6)

Type	Terminal			
Digital input 1 to 6	D11 to D61	GND1		
	Digital input 1 to 6 (+)	Ground (-) for digital inputs 1 to 6		

Type	Terminal			
Auxiliary voltage output, not stabilized, max. 250 mA			24V Out -	24V Out +
			- Ground	+ 24V (±15%)

**i** If the auxiliary voltage is to be used for the digital inputs, the **24 V out -** terminal of the auxiliary voltage output must be connected with the **GND1** terminal.

**Analog inputs (slot 1-5)**

The first digit (x) of the two-digit terminal number corresponds to the associated channel:

Type	Terminal					
	x1	x2	x3	x4	x5	x6
Current/pulse/frequency input <sup>1)</sup>					(+)	(-)
Voltage > 1V		(+)				(-)
Voltage ≤ 1V				(+)		(-)
Resistance thermometer RTD (2-wire)	(A)					(B)
Resistance thermometer RTD (3-wire)	(A)			b (sense)		(B)
Resistance thermometer RTD (4-wire)	(A)		a (sense)	b (sense)		(B)
Thermocouples TC				(+)		(-)

1) If a universal input is used as a frequency or pulse input, a series resistor must be used in series connection with the voltage source. Example: 1.2 kΩ series resistor at 24 V

**HART® inputs (slot 1-5)**

The first digit (x) of the two-digit terminal number corresponds to the associated channel:

Type	Terminal					
	x1	x2	x3	x4	x5	x6
HART® (4 to 20 mA)	SHD	H_1	H_2	R <sub>com</sub>	I+	I-

- i** A 250 Ω communication resistor (load) is installed on the device side between terminals x4 and x5.
- A 10 Ω resistor (shunt) is installed on the device side at the current input between terminals x5 and x6.
- Terminals x2 and x3 (H\_1 and H\_2) are jumpered internally.
- The internal HART® modem is located between terminals x2/x3 and x6.

**Relay extension (digital card, slot 5)**

Type	Terminal (max. 250 V, 3 A)			
Relay 7, 8	RA	RB	RC	RD
Relay 9, 10	RE	RF	RG	RH
Relay 11, 12	RI	RJ	RK	RL
	Switching contact	Normally open contact (1)	Switching contact	Normally open contact (2)

- 1) NO)
- 2) NO)

**i** The open or close function (= activation or deactivation of the relay coil) in a limit event can be configured in the setup: "Setup -> Advanced setup -> Outputs -> Relay -> Relay x". However, in the event of a power failure, the relay adopts its quiescent switch state regardless of the setting programmed.

**Analog outputs (digital card, slot 5)**

Type	Terminal			
Analog output 1-2	O15	O16	O25	O26
	Analog output 1 (+)	Ground, analog output 1 (-)	Analog output 2 (+)	Ground, analog output 2 (-)

**Extension of digital inputs (digital card, slot 5)**

Type	Terminal		
Digital input 7 to 14	D71 to DE1	GND2	GND2
	Digital input 7 to 14 (+)	Ground (-) for digital inputs 7 to 14	Ground (-) for digital inputs 7 to 14

**i** If the auxiliary voltage is to be used for the digital inputs, the **24 V out -** terminal of the auxiliary voltage output (power unit, slot 6) must be connected with the **GND2** terminal.

**6.3.3 Connection example: Auxiliary voltage output as transmitter power supply for 2-wire sensors**

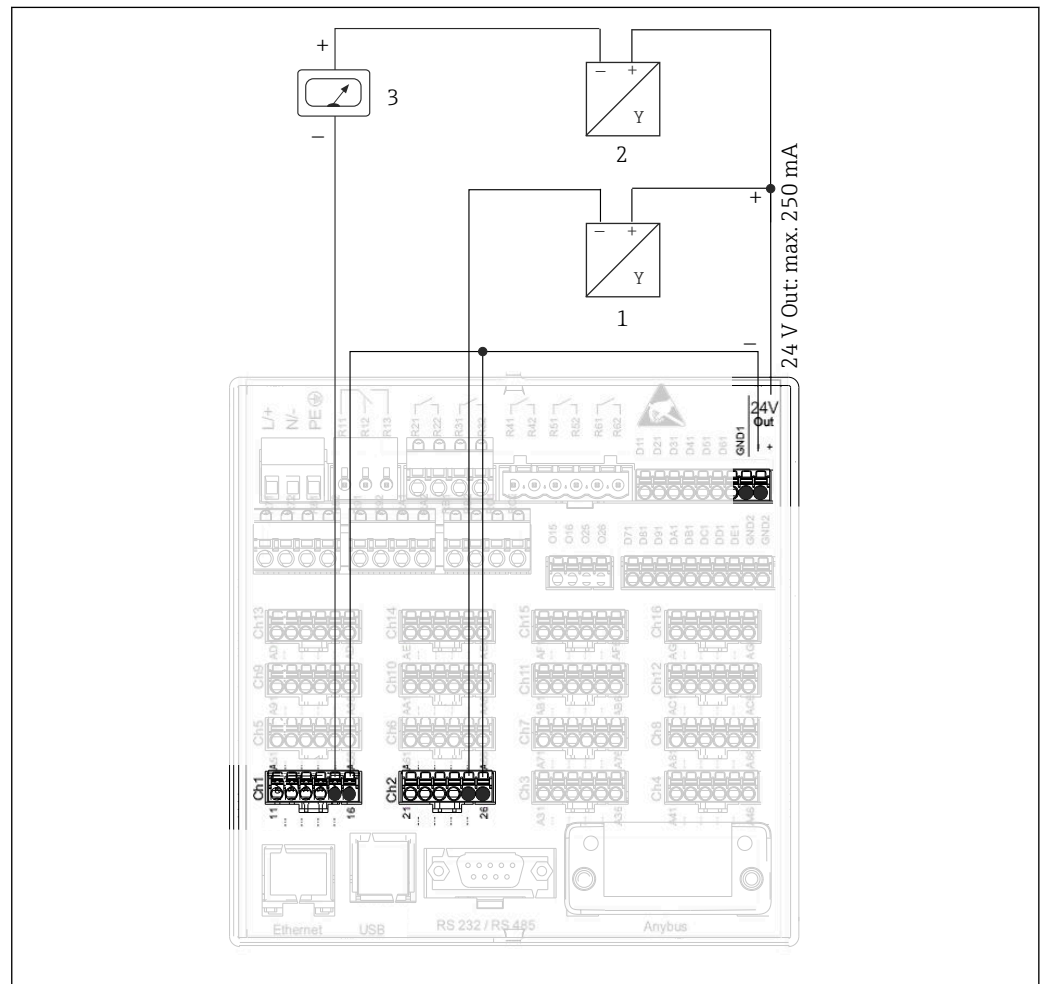

**9** Connecting the auxiliary voltage output when using as a transmitter power supply for 2-wire sensors in the current measuring range

- 1 Sensor 1 (e.g. Cerabar from Endress+Hauser)
- 2 Sensor 2
- 3 External indicator (optional) (e.g. RIA16 from Endress+Hauser)

### 6.3.4 Connection example: Auxiliary voltage output as transmitter power supply for 4-wire sensors

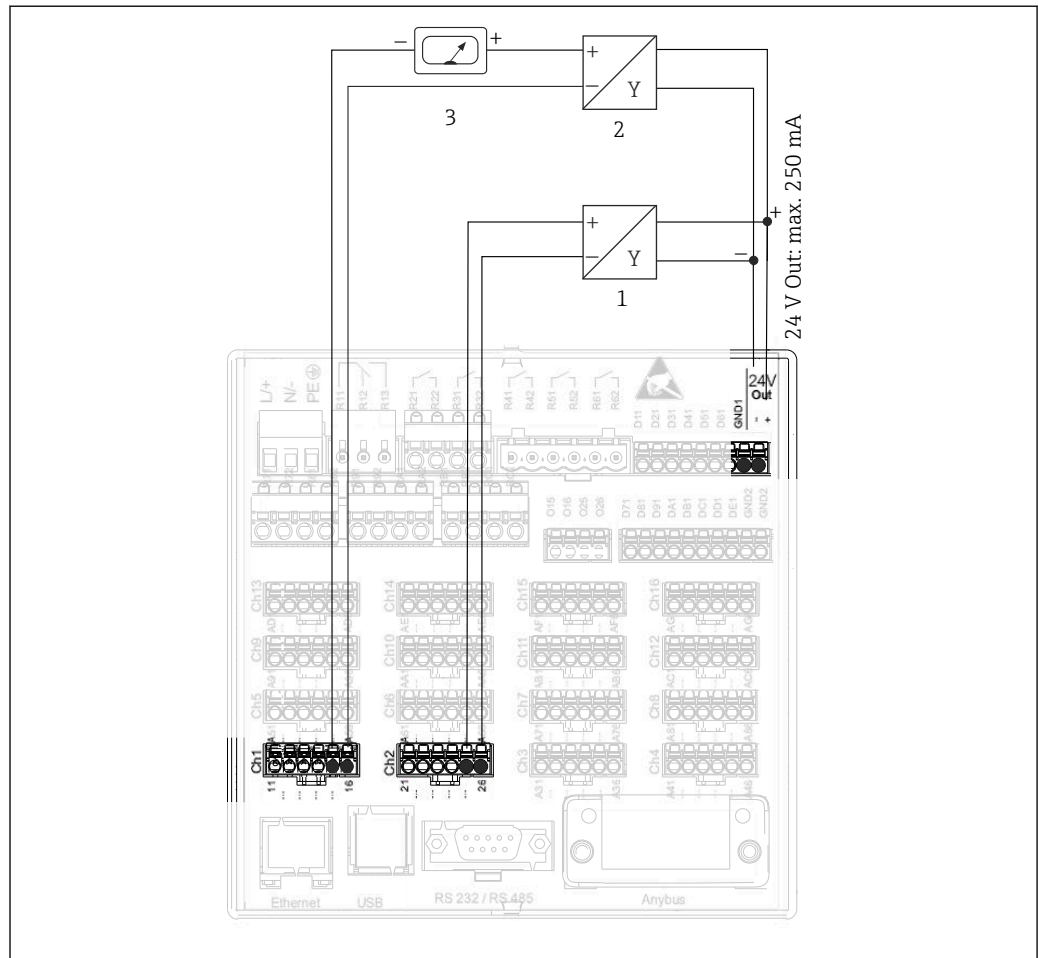

A0024730

10 Connecting the auxiliary voltage output when using as a transmitter power supply for 4-wire sensors in the current measuring range

- 1 Sensor 1 (e.g. temperature switch TTR31 from Endress+Hauser)
- 2 Sensor 2
- 3 External indicator (optional) (e.g. RIA16 from Endress+Hauser)



### 6.3.5 Connection example: HART® input in a point-to-point connection

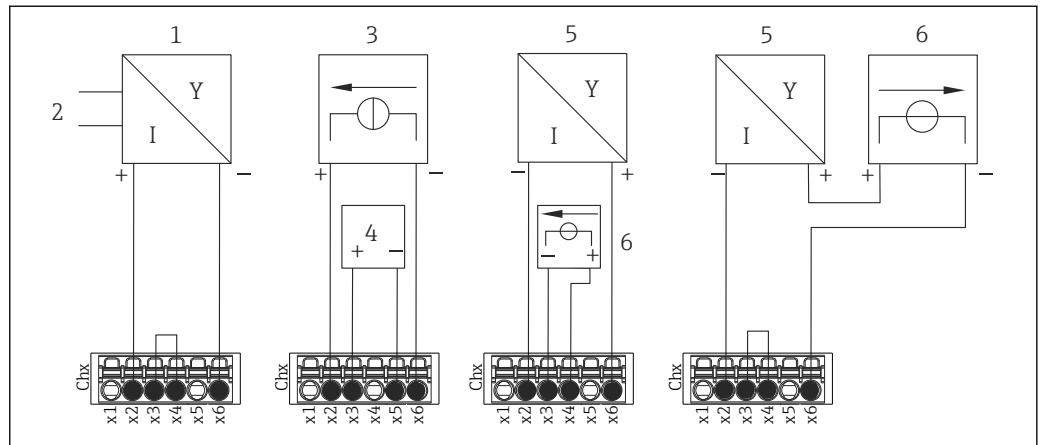

A0024864

11 Connection example: HART® inputs in a point-to-point connection

- 1 Active 4-wire sensor (slave)
- 2 Power supply for 4-wire sensor
- 3 Power supply (electricity source) for actuator
- 4 Actuator (e.g. adjuster or valve)
- 5 Passive 2-wire sensor (slave)
- 6 Power supply (supply point) for sensor.

**i** The internal auxiliary voltage (24 V OUT) can also be used as the transmitter power supply.

### 6.3.6 Connection example: HART® input in a Multidrop connection

**i** Information on HART® Multidrop topology:

- The analog signal is not available for the process variable. Only the digital signal is used.
- Multidrop topology is **not** recommended for time-critical applications due to the slower update rate.
- The device supports a maximum of 5 sensors per current loop. The address should be in the 1 to 15 range (compatibility with HART®5).

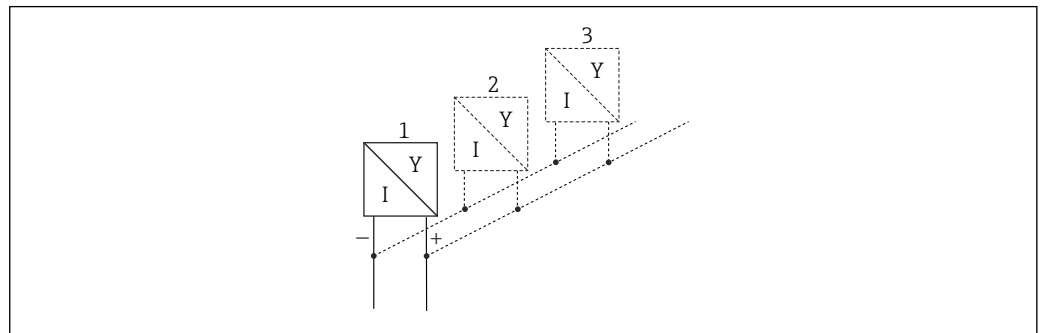

A0024860

12 Connection example: HART® input in a Multidrop connection

- 1 Sensor (slave 1)
- 2 Sensor (slave 2)
- 3 Sensor (slave 3-5)

**i** The internal auxiliary voltage (24 V OUT) can also be used as the transmitter power supply.

### 6.3.7 RS232/RS485 interface (CPU card, slot 0)

**i** Use shielded signal lines for serial interfaces!

A combined RS232/RS485 connection is available on a shielded SUB D9 socket. This can be used for data transfer and to connect a modem. For communication via modem, we recommend an industrial modem with a watchdog function.

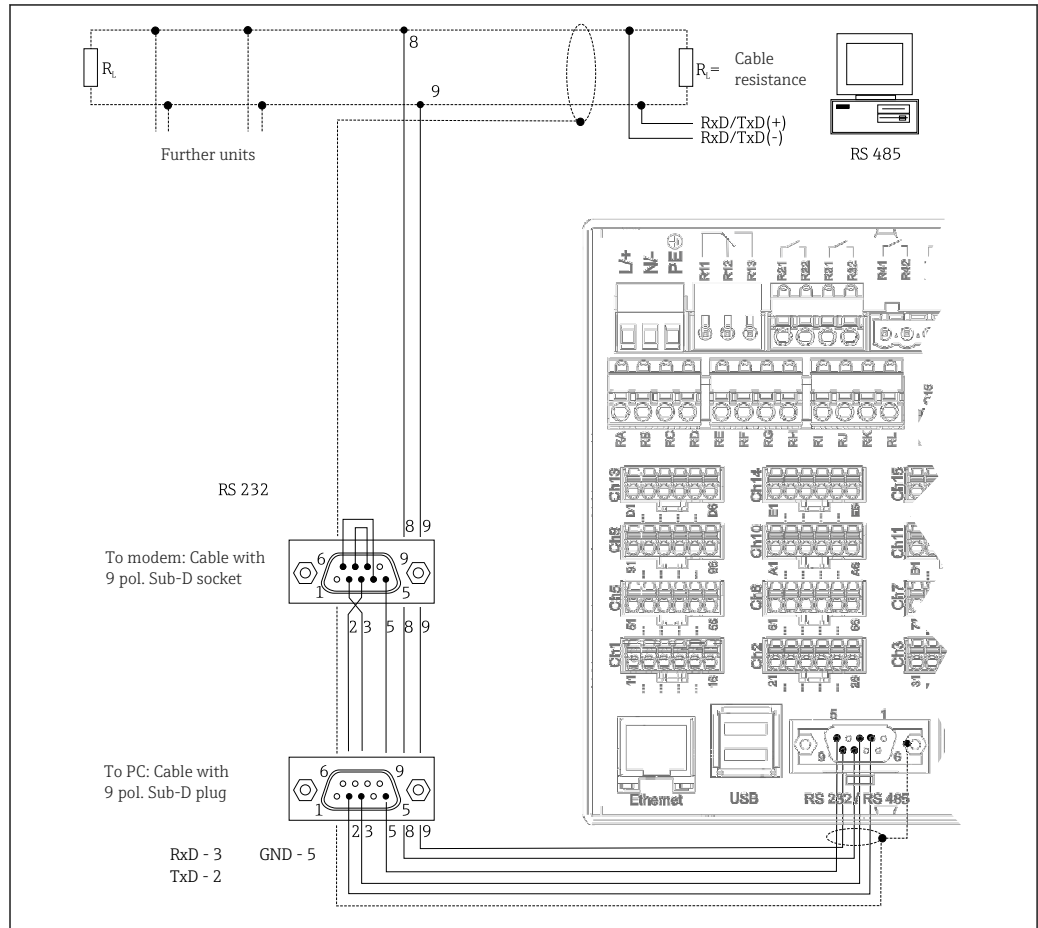

A0024732-EN

Type	Pin of the SUB-D9 socket								
	1	2	3	4	5	6	7	8	9
<b>RS232 assignment</b>		TxD (data output)	RxD (data input)		GND				
<b>RS485 assignment</b>					GND			RxD/TxD -	RxD/TxD +

Unoccupied connections should be left empty.  
 Maximum cable length:  
 RS232: 2 m (6.6 ft)  
 RS485: 1000 m (3280 ft)

**i** Only one interface can be used at any one time (RS232 or RS485).

#### Option: Modbus RTU master

As a Modbus master, the device can interrogate other Modbus slaves via RS485. The Modbus RTU master can be operated in parallel with the Profibus DP slave, EtherNet/IP adapter, PROFINET I/O device or Modbus TCP slave.

Up to 40 analog inputs can be transmitted via Modbus and stored in the device.

#### Option: Modbus RTU slave

The device can be interrogated as a Modbus slave by another Modbus master via RS485.

Up to 40 analog inputs and 20 (14 real + 6 virtual) digital inputs can be transmitted via Modbus and stored in the device.

 A Modbus RTU master and RTU slave cannot be operated in parallel.

#### Remote interrogation with analog or GSM/GPRS wireless modem:

##### Analog modem:

An analog modem for industrial use (e.g. Devolo or WESTERMO), which is connected to the RS232 interface with a special modem cable (see accessories →  97), is recommended.

##### GSM/GPRS wireless modem:

A GSM/GPRS wireless modem for industrial use (e.g. Cinterion, INSYS or WESTERMO, incl. antenna and power unit), which is connected to the RS232 interface with a special modem cable (see accessories →  97), is recommended.

Important: the wireless modem needs a SIM card and data transfer subscription. In addition, it must be possible to deactivate the PIN prompt.

 If the Web server is operated via a wireless modem, this may result in high provider costs as data are transmitted continuously.

### 6.3.8 Ethernet connection (CPU card, slot 0)

The Ethernet interface can be used to integrate the device via a hub or switch into a PC network (TCP/ IP Ethernet). A standard patch cable (e.g. CAT5E) can be used for the connection. Using DHCP, the device can be fully integrated into an existing network without the need for additional configuration. The device can be accessed from every PC in the network.

- Standard: 10/100 Base T/TX (IEEE 802.3)
- Socket: RJ-45
- Max. cable length: 100 m
- Galvanic isolation; test voltage: 500 V

The following functions are implemented:

- Data communication with PC software (analysis software, configuration software, OPC server)
- Web server

#### Meaning of the LEDs

Beneath the Ethernet connection there are two light emitting diodes which indicate the status of the Ethernet interface.

- Yellow LED: link signal; is lit when the device is connected to a network. If this LED is not lit, communication is not possible.
- Green LED: Tx/Rx; flashes irregularly if the device is transmitting or receiving data.

#### Requirements with regard to a network printer

The printer must support PCL5c (or higher). Laser jet and ink jet printers are supported. The printouts are always color printouts (if supported by the printer). The printout has different shades of gray if you use a black/white printer.

Reference list: HP Color LaserJet CP1515n, HP Color LaserJet Pro CP1525n, Kyocera FS-C5015N.

 GDI printers are not supported!

**Option: Ethernet Modbus TCP master**

As a Modbus master, the device can interrogate other Modbus slaves via Ethernet. The Modbus TCP master can be operated in parallel with the Profibus DP slave, Modbus RTU, Modbus TCP slave, EtherNet/IP adapter or PROFINET I/O device.

Up to 40 analog inputs can be transmitted via Modbus and stored in the device.

**Option: Ethernet Modbus TCP slave**

The Modbus TCP interface is used to connect to higher-ranking SCADA systems (Modbus master) to transmit all measured values and process values.

Up to 40 analog inputs and 20 (14 real + 6 virtual) digital inputs can be transmitted via Modbus and stored in the device.

**6.3.9 Option: Anybus<sup>®</sup> interface (CPU card, slot 0)****PROFIBUS-DP slave:**

The device can be integrated into a fieldbus system as per the PROFIBUS-DP standard by means of the PROFIBUS-DP interface. Up to 40 analog inputs and 20 (14 real + 6 virtual) digital inputs can be transmitted via PROFIBUS-DP and stored in the device. For bidirectional communication in cyclic data transfer. Connection via Sub-D socket.

Baud rate: maximum 12 Mbit/s

**EtherNet/IP adapter (slave):**

Up to 40 analog inputs and 20 (14 real + 6 virtual) digital inputs can be transmitted via EtherNet/IP and stored in the device. The built-in module corresponds to I/O server category (Level 2). It has an integrated 2-port switch, thereby supporting EtherNet/IP communication with line or ring topology. Connection via 2 RJ45 standard sockets.

**PROFINET I/O device:**

Up to 40 analog inputs and 20 (14 real + 6 virtual) digital inputs can be transmitted via PROFINET IO and stored in the device. The 2-port module for Profinet IO meets compliance class B. The integrated switch enables communication in line or ring topologies without an additional external switch. Connection via 2 RJ45 standard sockets.

**6.3.10 USB connection, type A (host) (CPU card, slot 0)**

Two USB-2.0 ports are available (panel version) or one USB-2.0 port is available (DIN rail version) on shielded USB-A sockets. A USB stick as a memory medium, for example, can be connected to these ports. An external keyboard/mouse for device operation, a USB hub, a barcode reader or a printer (PCL5c or higher) may also be connected.

### 6.3.11 Front of device (version with navigator and front interfaces)

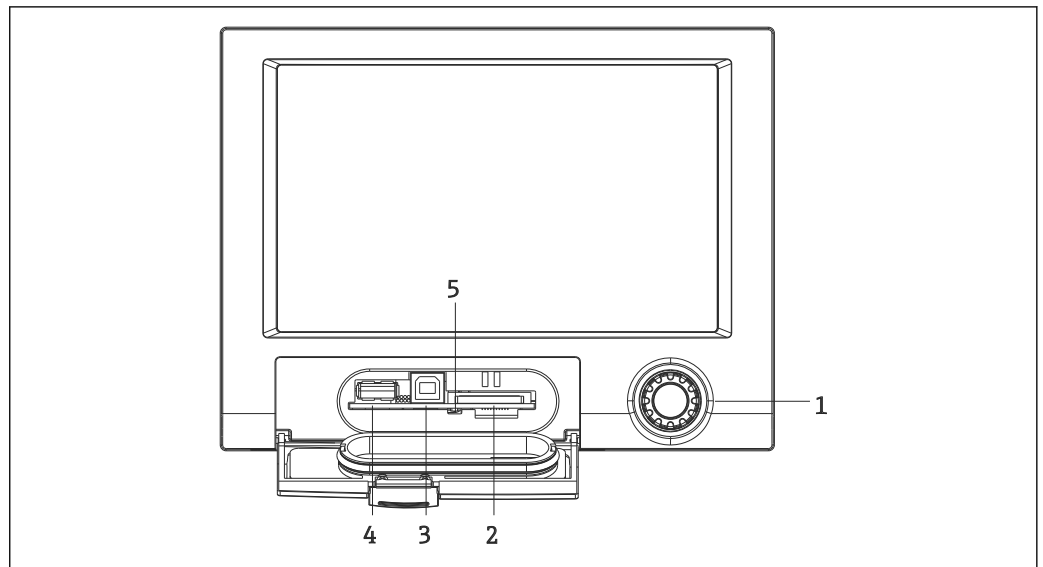

 13 Version with navigator and front interfaces with open flap

- 1 Navigator
- 2 Slot for SD card
- 3 USB B socket "Function" e.g. to connect to PC or laptop
- 4 USB A socket "Host" e.g. for USB memory stick, external keyboard/mouse, USB hub, barcode reader or printer
- 5 LED at SD slot. Yellow LED lit or flashing when the device writes to the SD card or reads it.

#### USB connection type A (host)

A USB 2.0 port is available on a shielded USB A socket at the front of the device. A USB stick as a memory medium, for example, can be connected to this port. An external keyboard/mouse for device operation, a USB hub, a barcode reader or a printer (PCL5c or higher) may also be connected.



#### USB connection type B (function)

A USB 2.0 port is available on a shielded USB B socket at the front of the device. This can be used to connect the device for communication with a laptop, for example. →  43

 USB-2.0 is compatible with USB-1.1 or USB-3.0, i.e. communication is possible.

#### Requirements for the SD card

Industrial grade SD-HC cards with max. 32 GB are supported.

 Use only the industrial grade SD cards described in the "Accessories" section of the Operating Instructions. These have been tested by the manufacturer and are guaranteed to function faultlessly in the device. →  97



 The SD card must be formatted to FAT or FAT32. NTFS format is not readable.

### 6.3.12 General information on USB devices

The USB devices are detected by the "plug-and-play" function. If several devices of the same type are connected, only the USB device that was connected first is available. Settings for the USB devices are made in the setup. A maximum of 8 external USB devices (incl. USB hub) can be connected if they do not exceed the maximum load of 500 mA. If overloaded, the corresponding USB devices are automatically disabled. An active USB hub can be used for higher power ratings.

### Requirements with regard to the USB stick

There is no guarantee that all manufacturers' USB sticks will function faultlessly. That is why an industrial grade SD card is recommended to ensure the reliable recording of data.  
→ 📄 97

-  The USB stick must be formatted to FAT or FAT32. NTFS format is not readable. The system supports only USB sticks with max. 32 GB.
-  The USB stick must not be connected to the device via a USB hub. Interference from other USB devices may result in data loss.

### *Requirements with regard to an external USB keyboard*

The system only supports keyboards which can be addressed using generic drivers (HID keyboard - Human Interface Device). Special keys are not supported (e.g. Windows keys). Users can only enter characters that are available in the input character set of the device. All unsupported characters are rejected. It is not possible to connect a wireless keyboard. The following keyboard layouts are supported: DE, CH, FR, USA, USA International, UK, IT. See setting under "Setup -> Advanced setup -> System -> Keyboard layout".

### *Requirements with regard to an external USB barcode reader*

The connected barcode reader has to act like a HID keyboard (human interface device) (universal keyboard driver). The barcode reader must complete every barcode with a carriage return (0x0D) + line feed (0x0A).

### Checking the barcode reader at a PC

Before connecting the barcode reader to the device, it should be checked at a Windows® PC.

1. Connect the barcode reader to the PC and wait until Microsoft Windows® recognizes the device as a HID keyboard and installs it (check with the Windows Device Manager).
2. Configure the barcode reader as specified in the Operating Instructions of the barcode reader.
3. Start the Notepad (editor).
4. Using the barcode reader, read in a barcode (as it is used later) and check it.
5. Do not connect the barcode reader to the device until the barcode reader has been correctly configured and tested on the PC.
6. Select the character set at the device under "Setup -> Advanced setup -> System -> Barcode reader -> Character set". The following character sets are supported: DE, CH, FR, USA, USA International, UK, IT. Note: This setting has to be identical to the configuration of the barcode reader! The system only reads characters that are available in the entry character set of the device. All other characters are rejected.
7. The barcode reader should also be tested at the device via "Main menu -> Diagnostics -> Simulation -> Test barcode reader" (function not available with DIN rail version).

If problems arise, please contact the manufacturer of the barcode reader.

Reference list: Datalogic Gryphon D230, Metrologic MS5100 Eclipse Series, Symbol LS2208, Datalogic Quickscan 1, Godex GS220, Honeywell Voyager 9590.

### *Requirements with regard to an external USB printer*

The printer must support PCL5c (or higher). Laser jet and ink jet printers are supported. The printouts are always color printouts (if supported by the printer). The printout has different shades of gray if you use a black/white printer.

Reference list: HP Color LaserJet CP1515n, HP Color LaserJet Pro CP1525n, Kyocera FS-C5015N.



GDI printers are not supported!

## 6.4 Post-connection check

Device condition and specifications	Notes
Are cables or the device damaged?	Visual inspection
Electrical connection	Notes
Does the supply voltage match the specifications on the nameplate?	-
Are all terminals firmly engaged in their correct slot?	-
Are the mounted cables strain-relieved?	-
Are the power supply and signal cables correctly connected?	See connection diagram and device.

## 7 Operation options

### 7.1 Overview of operation options

The device can be operated directly onsite with the navigator and USB keyboard/mouse (only panel-mounted device) or via interfaces (serial, USB, Ethernet) and operating tools (Web server); FieldCare/DeviceCare configuration software).

The DIN rail device is operated exclusively via the operating tools.

### 7.2 Structure and function of the operating menu

 The layout and structure of the operating menu can differ slightly in parts on the Web server.



### 7.2.1 Operating menu for operators and maintenance personnel

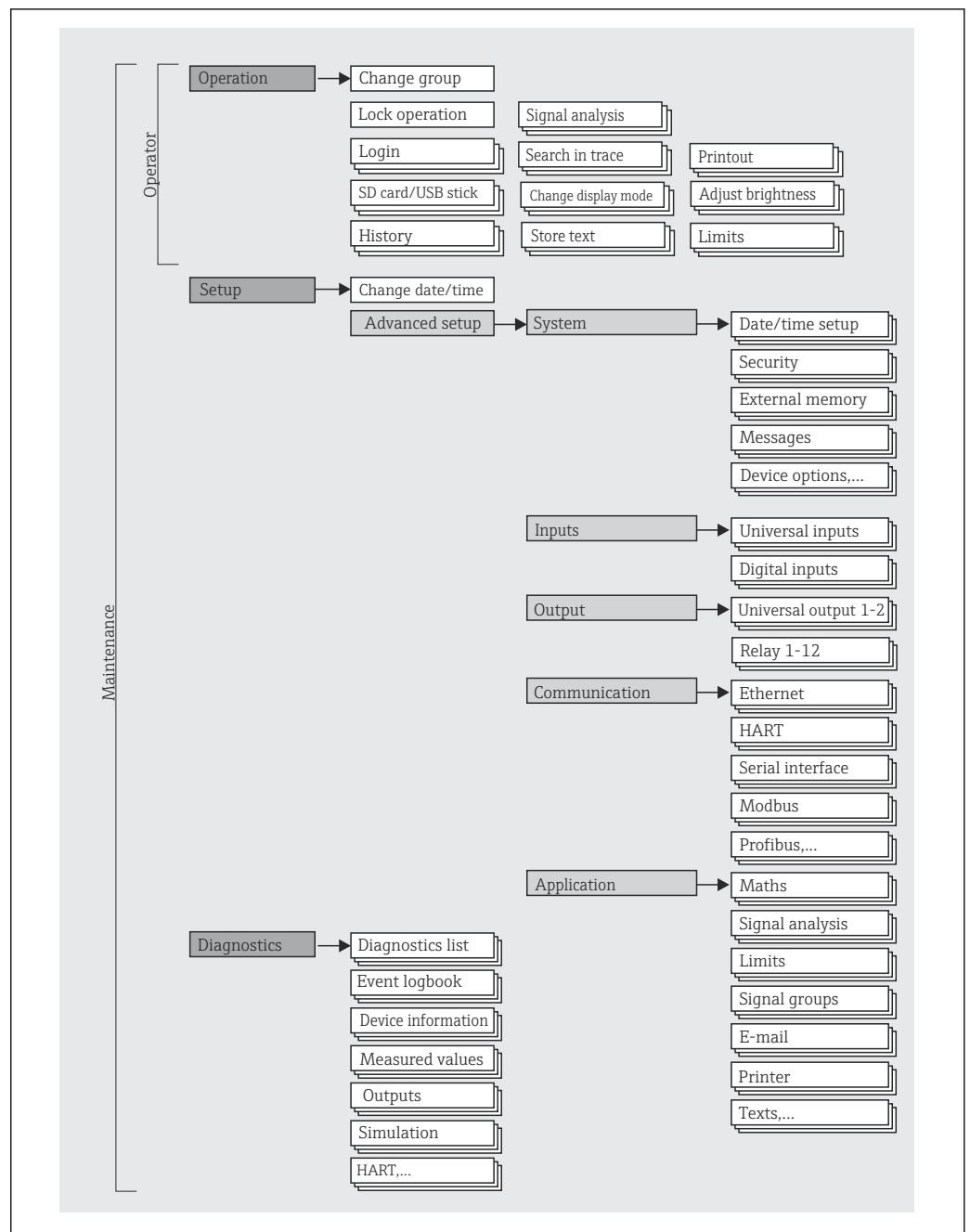

### 7.2.2 Operating menu for experts

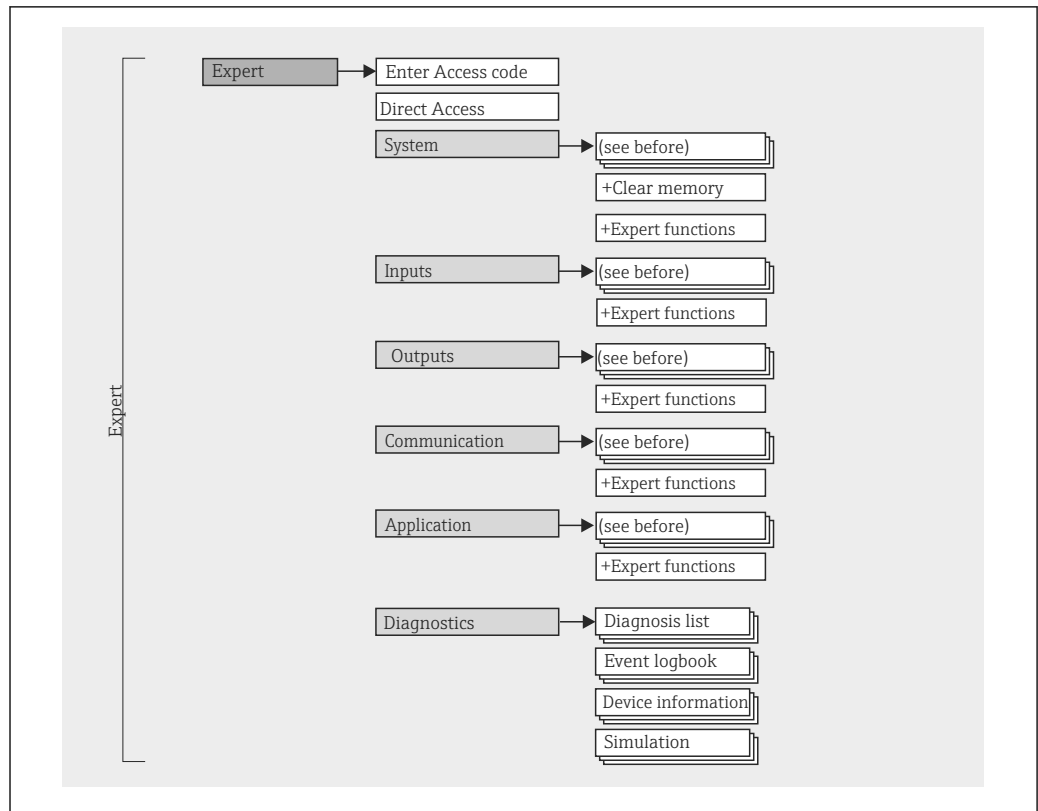

A0019596-EN

### 7.2.3 Submenus and users

Certain parts of the menu are assigned to certain user roles. Each user role corresponds to typical tasks within the lifecycle of the device.

User role	Typical tasks	Menu	Content/meaning
Operator	Tasks during operation: <ul style="list-style-type: none"> <li>▪ Configuration of the display.</li> <li>▪ Reading measured values.</li> </ul>	"Operation"	Contains all the parameters that are required in ongoing operation: configuration of the measured value display (displayed values, display format, etc.).
Maintenance	Commissioning: <ul style="list-style-type: none"> <li>▪ Configuration of the measurement.</li> <li>▪ Configuration of data processing.</li> </ul>	"Setup"	Contains all parameters for commissioning: <ul style="list-style-type: none"> <li>▪ <b>Change date/time</b></li> <li>▪ <b>"Advanced setup" submenu</b> Contains additional submenus and parameters:                             <ul style="list-style-type: none"> <li>▪ <b>System:</b> Basic settings required for operating the device.</li> <li>▪ <b>Inputs:</b> Settings for analog and digital inputs.</li> <li>▪ <b>Outputs:</b> Setup required only if outputs (e.g. relays) are to be used.</li> <li>▪ <b>Communication:</b> Settings required if the USB, RS232, RS485 or Ethernet interface or the HART® inputs of the device are used (PC operation, serial data read-out, modem operation, etc).</li> <li>▪ <b>Application:</b> Various application-specific settings (e.g. group settings, limit values, etc.).</li> </ul> </li> </ul> Once values have been set for these parameters, the measurement should generally be completely configured.

User role	Typical tasks	Menu	Content/meaning
	<p>Troubleshooting:</p> <ul style="list-style-type: none"> <li>▪ Diagnosing and eliminating process errors.</li> <li>▪ Interpretation of device error messages and correcting associated errors.</li> </ul>	<p>"Diagnostics"</p>	<p>Contains all parameters for detecting and analyzing errors:</p> <ul style="list-style-type: none"> <li>▪ <b>Diagnosis list</b> All diagnosis messages are listed in chronological order.</li> <li>▪ <b>Event logbook</b> Events such as alarm set point infringement and power failure are listed in the correct time sequence.</li> <li>▪ <b>Device information</b> Displays important device information (e.g. serial number, firmware version, device options for hardware and software, memory information, etc.).</li> <li>▪ <b>Measured values</b> Display of current measured values of the device.</li> <li>▪ <b>Outputs</b> Displays the current status of the outputs e.g. switch status of relay outputs.</li> <li>▪ <b>Simulation</b> Various functions/signals can be simulated for test purposes here. <b>Note:</b> In Simulation mode, normal recording of the measured values is interrupted and the intervention is logged in the event log.</li> <li>▪ <b>HART®</b> Displays the exact device information of a selected HART® device and the HART® communication signal quality.</li> <li>▪ <b>Initialize modem</b> Initializes the modem connected to the serial interface (for automatic call answering).</li> </ul>
<p>Expert</p>	<p>Tasks that require detailed knowledge of the function of the device:</p> <ul style="list-style-type: none"> <li>▪ Commissioning measurements under difficult conditions.</li> <li>▪ Optimal adaptation of the measurement to difficult conditions.</li> <li>▪ Detailed configuration of the communication interface.</li> <li>▪ Error diagnostics in difficult cases.</li> </ul>	<p>"Expert"</p>	<p>Contains all the parameters of the device (including those that are already contained in one of the other submenus). The expert menu is protected by a code. Factory setting: 0000. This menu is structured according to the function blocks of the device:</p> <ul style="list-style-type: none"> <li>▪ <b>"System" submenu</b> Contains all higher-level device parameters that do not pertain either to the measurement or measured value communication.</li> <li>▪ <b>"Inputs" submenu</b> Contains all parameters for configuring the analog and digital inputs.</li> <li>▪ <b>"Output" submenu</b> Contains all parameters for configuring the outputs (e.g. relays).</li> <li>▪ <b>"Communication" submenu</b> Contains all parameters for configuring the communication interfaces.</li> <li>▪ <b>"Application" submenu</b> Contains all parameters for configuring application-specific settings (e.g. group settings, limit values etc.).</li> <li>▪ <b>"Diagnostics" submenu</b> Contains all parameters to detect and analyze operational errors.</li> </ul>

### 7.3 Measured value display and operating elements

#### 7.3.1 Measured value display and operating elements on panel-mounted device

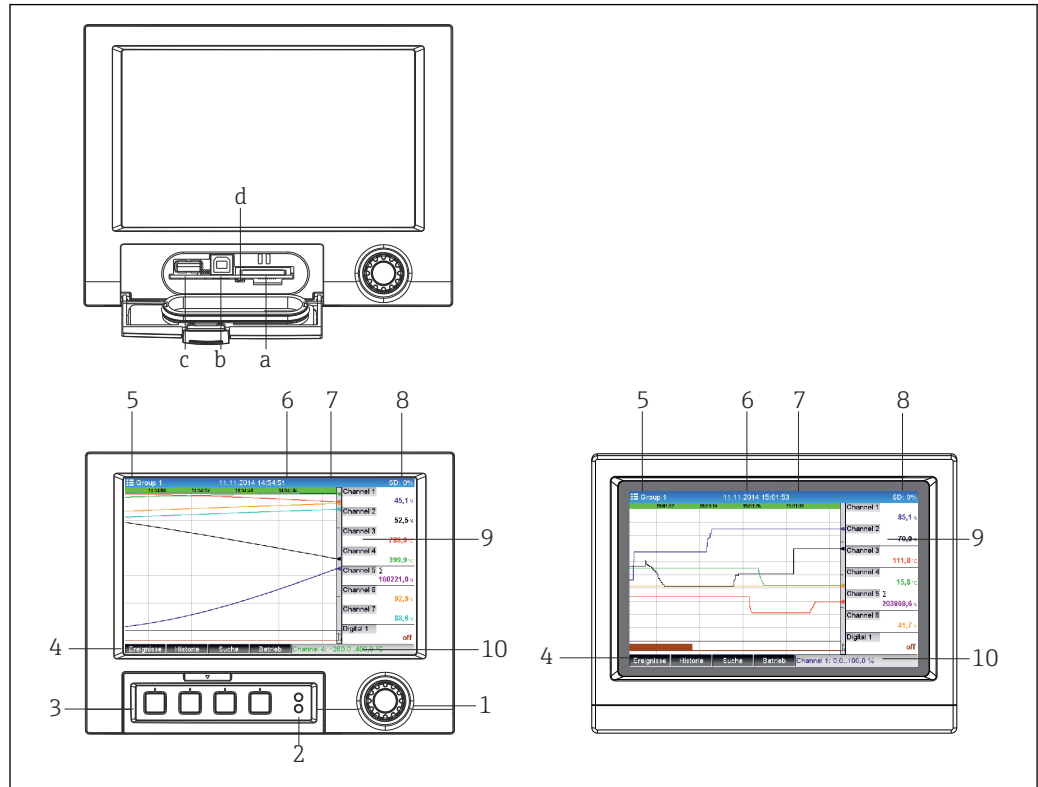

A0024709

14 Device front (left: version with navigator and front interfaces; right: version with stainless steel front and touchscreen)

Item No.	Operating function (display mode = display of measured values) (Setup mode = operation in the Setup menu)
a	Slot for SD card
b	USB B socket "Function" e.g. to connect to PC or laptop
c	USB A socket "Host" e.g. for USB memory stick, external keyboard, barcode reader or printer
d	LED at SD slot. Yellow LED lit or flashing when the device writes to the SD card or reads it.  <b>Do not remove the SD card if the LED is lit or flashing! Risk of data loss!</b>
1	"Navigator": jog/shuttle dial for operating with additional press/hold function. In display mode: turn the dial to switch between the various signal groups. Press the dial to display the main menu. In setup mode or in a selection menu: turn the dial anticlockwise to move the bar or the cursor upwards or to the left, changes the parameter. Turning clockwise moves the bar or cursor down or to the right, changes the parameter. Press = select highlighted function, start parameter change (ENTER key).
2	Functions of LED indicators (according to NAMUR NE44:): <ul style="list-style-type: none"> <li>■ Green LED (top) lit: power supply OK</li> <li>■ Red LED (bottom) flashing: maintenance required, caused by external factor (e.g. cable open circuit etc.) or a message/notification requiring acknowledgment is pending, calibration is running.</li> </ul>
3	Variable "soft keys" 1-4 (from left to right)
4	Function indicator of "soft keys"
5	In display mode: current group name, type of analysis; In setup mode: name of the current operating item (dialog title)



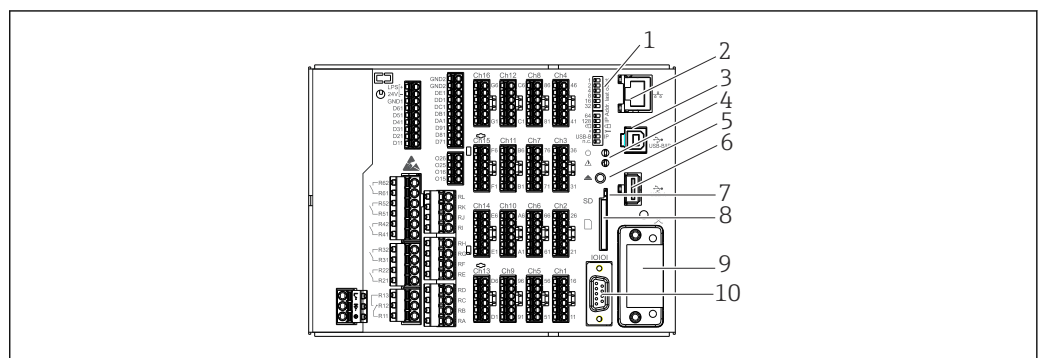

Item No.	Operating function (display mode = display of measured values) (Setup mode = operation in the Setup menu)
6	In display mode: displays current date/time In setup mode: --
7	In display mode: user ID (if function is active) In setup mode: --
8	In display mode: alternating display indicating the percentage space on the SD card or USB stick that has already been used. Status symbols are also displayed in alternation with the memory information (e.g. simulation mode, data storage active, operation lock, batch active) In setup mode: the current "direct access" operating code is displayed
9	In display mode: window for measured value display (e.g. curve display). Display of current measured values and the status in the event of an error/alarm condition. In the case of counters, the type of counter is displayed as a symbol.  If a measuring point has limit value status, the corresponding channel identifier is highlighted in red (quick detection of limit value violations). During a limit value violation and device operation, the acquisition of measured values continues uninterrupted.
9	In setup mode: display of operating menu
10	In display mode: alternating status display (e.g. set zoom range) of the analog or digital inputs in the appropriate color of the channel. In setup mode: different information is displayed here depending on the display type.

### 7.3.2 Operating elements of the DIN rail version



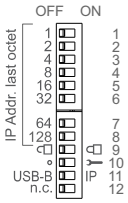





A0036811

 15 Device front of the DIN rail version





Item No.	Operating function
1	<p><b>DIP switches</b>                      The behavior of the Ethernet interface is configured via DIP switches (left = OFF, right = ON).                      For a detailed description of the DIP switch functions → 50</p> <p>Function of the DIP switches (1 = top, 12 = bottom):</p> <ul style="list-style-type: none"> <li>▪ DIP switches 1-8: configuration of IP address in last octet (e.g. 192.168.1.<b>212</b>)</li> <li>▪ DIP switch 9:                              OFF = setup change not locked                              ON = setup locked</li> <li>▪ DIP switch 10:                              OFF = default / OFF                              ON = service addressing</li> <li>▪ DIP switch 11 for the configuration of the USB-B interface:                              OFF = USB standard                              ON = Ethernet via USB (Web server)</li> <li>▪ DIP switch 12: not assigned</li> </ul> <p> The DIN rail version is supplied with the following Ethernet settings:                      IP address: 192.168.1.212; subnet mask: 255.255.255.0; gateway: 0.0.0.0</p> 
2	Ethernet interface
3	USB B socket "Function" e.g. to connect to PC or laptop
4	<p>Functions of LED indicators (according to NAMUR NE44:)</p> <ul style="list-style-type: none"> <li>▪ Green LED (top) lit: power supply OK</li> <li>▪ Red LED (bottom) flashing: maintenance required, caused by external factor (e.g. cable open circuit etc.) or a message/notification requiring acknowledgment is pending, calibration is running.</li> </ul>
5	<p>Cyclic storage is completed via the "Remove SD card safely" button, the LED (d) goes out. The SD card can now be removed.</p> <p> If the SD card is not removed within 5 minutes, the write cycles start again.</p>
6	<p>USB A socket "Host" e.g. for USB memory stick or printer                      If a USB stick is inserted, data that have not yet been saved are copied to the stick automatically. The red LED on the USB socket flashes while the data are being copied to the stick.</p> <p> <b>Do not remove the USB stick when the red LED is flashing! Risk of data loss!</b></p> <p>If an error occurs (e.g. USB stick full or defective), the red LED is lit constantly. Remove the USB stick and replace it.</p>
7	<p>LED at SD slot. Yellow LED lit or flashing when the device writes to the SD card or reads it.</p> <p> <b>Do not remove the SD card if the LED is lit or flashing! Risk of data loss!</b></p>
8	Slot for SD card
9	Anybus® interface (option)
10	Serial RS232/RS485 interface

## 7.4 Display representation of symbols used in operation









Item No.	Function	Description
9	<b>Symbols for counters:</b>	
	$\Sigma 1, \Sigma 2, \Sigma 3, \Sigma 4$	Intermediate analysis 1 to 4 / external analysis 1 to 4
	$\Sigma D$	Daily analysis
	$\Sigma W$	Weekly analysis
	$\Sigma M$	Monthly analysis
	$\Sigma Y$	Annual analysis

Item No.	Function	Description
	Σ	Totalizer
9	<b>Channel-related symbols:</b>	
		Violation of lower limit value
		Violation of upper limit value or limit value on counter
		Violation of upper and lower limit values at the same time
	<b>S</b>	<b>"Out of specification"</b> e.g. input signal too high/low
	<b>F</b>	<b>Error message "Failure detected"</b> An operating error has occurred. The measured value is no longer valid (e.g. a channel not displayed in the current group is defective).
	<b>M</b>	<b>"Maintenance required"</b> Maintenance is required. The measured value remains valid.
	-----	<b>Error, measured value not displayed.</b> Possible causes: Sensor / input error, line break, invalid value, input signal too high/low
8	<b>Symbol for status signals:</b>	
		<b>"Device locked"</b> Setup is locked via a control input. Disable setup lock via a control input.
	<b>S</b>	<b>"Out of specification"</b> The device is being operated outside its technical specifications (e.g. during startup or cleaning).
	<b>C</b>	<b>"Function check"</b> The device is in Service mode.
	<b>M</b>	<b>"Maintenance required"</b> Maintenance is required. The measured value remains valid.
	<b>F</b>	<b>Error message "Failure detected"</b> An operating error has occurred. The measured value is no longer valid (e.g. a channel not displayed in the current group is defective).
		<b>"External communication"</b> The device is communicating externally (e.g. via Modbus).
	SIM	<b>"Simulation"</b> Simulation is active.
4		<b>"Historical data"</b> Historical data are currently shown on screen.

### 7.4.1 Symbols in operating menus

	Symbol for setup
	Symbol for diagnostics
	Symbol for expert setup
	Symbol for user administration according to "FDA 21 CFR Part 11"
<b>×</b>	Back The function "Back" appears at the end of each menu/submenu. Press "Back" briefly to go up one level in the menu structure.
	Press and hold "Back" (>3 sec.) to quit the menu immediately. The device switches to Display mode.

### 7.4.2 Symbols in the event logbook

	Setup changes
	Power on
	Power off
	Limit value on
	Limit value off
1	Digital on (on/off message)
0	Digital off (on/off message)
	Service
	User administration
	Texts saved / comments added
<b>OK</b>	Acknowledging message
<b>X</b>	Back
	Continue searching

### 7.5 Entering text and numbers (virtual keyboard)

A virtual keyboard is available for entering text and numbers. This is opened automatically if needed. The appropriate character is selected by turning and pressing the navigator, or by using the touchscreen or mouse.

The following characters are available for entering customized text:

0-9 a-z A-Z = + - \* / \ ^ 2 3 ¼ ½ ¾ ( ) [ ] < > { } I ? ! ` " ' ^ % ° . , : \_ μ & # \$ € @ § £ ¥ ~

←	Jump one position to the left. If this symbol is selected, the cursor jumps one position to the left.
→	Jump one position to the right. If this symbol is selected, the cursor jumps one position to the right.
←x	Delete backwards. If this symbol is selected, the character to the left of the cursor position is deleted.
x→	Delete forwards. If this symbol is selected, the character to the right of the cursor position is deleted.
<b>C</b>	Delete all. If this symbol is selected, the entire entry is deleted.
<b>X</b>	Reject entry. If this symbol is selected, the entry is rejected and you quit editing mode. The previously set text remains.
✓	Accept entry. If this symbol is selected, the entry is applied at the position specified by the user, and you quit editing mode.

### 7.6 Channel color assignment

Channel color assignment is performed in the main menu under "**Setup -> Advanced setup -> Application -> Signal groups -> Group x**". 8 predefined colors are available per group and can be assigned to the desired channels.



## 7.7 Access to the operating menu via the local display

Using the "Navigator" (jog/shuttle dial with additional press/hold function), the "soft keys" or touch control (optional) all settings can be made directly onsite at the device.

## 7.8 Device access via operating tools

### 7.8.1 Field Data Manager (FDM) analysis software (SQL database support)

The PC analysis software offers external, centralized data management with visualization for recorded data. The analysis software enables the complete archiving of all measuring point data e.g. measured values, diagnostic events and protocols. The analysis software stores data in an SQL database. The database can be operated locally or in a network (client/server). Access is via RS232/RS485, USB or Ethernet interface (network).

Function scope:

- Export of saved data (measured values, analyses, event log)
- Visualization and processing of saved data (measured values, analyses, event log)
- Safe archiving of exported data in a SQL database

The following versions of the software are available:

- Essential version (free, with limited functionalities)
- Professional version (see Accessories →  97)
- Demo version (time-limited Professional version)



 An "Essential" version of the analysis software is supplied with the device.

 For details, see the Operating Instructions on the analysis software DVD provided.

### 7.8.2 Web server

A Web server is integrated into the device. This makes the current measured values of the device available in real time. Access is via an Ethernet interface from a PC in the network via the standard browser. The installation of additional software is not required. Alternatively, the Web server can be operated in a point-to-point connection (Ethernet over USB) with a standard USB cable via the USB B port. →  43

The Web server offers the following range of functions:

- Display of current and historical data and measured value curves via a standard Web browser →  62
- Easy configuration without additional installed software →  46
- Remote access to device and diagnostic information

### 7.8.3 OPC server (optional)

The OPC server makes it possible to access data on the device. These data are made available to OPC clients in real time. The OPC server meets the requirements of the OPC specifications regarding the supply of data to an OPC client. Access is via RS232/RS485, USB or Ethernet interface (network). Communication takes place using automatic device detection; the operator does not need to make any additional settings. The OPC server enables the flexible and powerful exchange of data and is easy and convenient to use.

The following instantaneous values can be provided:

- Analog channels
- Digital channels
- Mathematics
- Totalizer



For details, see Operating Instructions BA00223R/09/xx

## 7.8.4 FieldCare/DeviceCare configuration software

### Function scope

The configuration software is an FDT/DTM-based system asset management tool. It can configure all smart field devices in a system and helps you manage them. By using the status information, it is also a simple but effective way of checking their status and condition. Access is via USB or Ethernet interface (network).

Typical functions:

- Device configuration
- Loading and saving device data (upload/download)
- Documentation of the measuring point



Download at: [www.endress.com/download](http://www.endress.com/download)

*Overview of device description files (DTM)*

Information and files are available free of charge at:



See online at: [www.de.endress.com/fieldcare](http://www.de.endress.com/fieldcare)

## 8 System integration

### 8.1 Integrating the measuring device in the system

#### 8.1.1 General notes

The device has (optional) fieldbus interfaces for exporting process values. Measured values and statuses can also be transmitted to the device via fieldbus.

Note: Counters cannot be transferred.

Depending on the bus system, alarms or faults occurring during data transmission are displayed (e.g. status byte).

The process values are transferred in the same units that are used to display the values on the device.

#### **Information on compliance with FDA 21 CFR Part 11 requirements when using fieldbus systems:**

If no measured values are received via fieldbus, the device activates a potential-free switch contact (e.g. relay) following an adjustable timeout. The evaluation of the switching contact is the responsibility of the user.

#### 8.1.2 Ethernet

**Setup** → **Advanced setup** → **Communication** → **Ethernet**

The IP address can be entered manually (fixed IP address) or assigned automatically using DHCP.

The port for data communication is preset to 8000. The port can be changed in the **Expert** → **Communication** → **Ethernet** menu.

The following functions are implemented:

- Data communication with PC software (analysis software, configuration software, OPC server)
- Web server

The following connections are possible at the same time:

- 1x Port 8000 (configuration software, OPC server or analysis software)
- 1x Port 8002 (OPC server only)
- 1x Port 5094 (HART® IP)
- 4x Modbus slave TCP
- 5x Web server

 Ports can be changed!

As soon as the maximum number of connections has been reached, new connection attempts are blocked until an existing connection has been terminated.

#### 8.1.3 Web server with "Ethernet over USB" function

To provide easy and efficient access via Web server for operation, setup and commissioning, the USB-B interface can be switched to the "Ethernet over USB" mode. Ethernet communication is established here via the USB interface. This has the advantage that the Ethernet interface in the case of commissioning laptops, for example, does not need to be reconfigured (IP address, ports, etc.). Instead, a standard USB cable can be used

to establish a point-to-point connection. The Web server itself retains its complete range of functionality.

**i Important information:**

- Do not connect several devices via USB to a laptop/PC at the same time
- The PC should not be connected to "Ethernet via USB" (USB-B connector on front panel of device) and a standard Ethernet network (RJ45 connector on rear panel of device) simultaneously if both connections use the same address parameters.
- Driver software (EH ECM device) must be installed on the PC.
- The "Ethernet over USB" mode is not a gateway, i.e. the Ethernet/RJ45 and USB networks are separate from each other (no two-way access).
- The USB cable should be disconnected from the device for at least 10 s before being reconnected (prevention of errors due to response time of system)
- It takes at least 10 s before the USB driver is activated by Windows and communication with the device is possible.
- Initialization of the USB interface takes place when the PC and device are connected via a USB cable.

**i Supported services/functions**

The following services/functions are provided via the USB interface:

- Web server
- CDI TCP (port 8000)
- WebDAV server

All other services/functions are available only by Ethernet via RJ45!

**Driver installation at PC end**

To use the Web server via USB, a driver must be installed once at the PC end.

1. The driver can be found under ".\Drivers\USB\_ECM" on the Field Data Manager (FDM) software DVD supplied.
2. Alternatively: Download "USB\_ECM.zip" at [www.endress.com/downloads](http://www.endress.com/downloads)
3. Execute the "setup.exe" and follow the instructions.

The necessary drivers are installed.

**i** From version V1.04.01 of the Field Data Manager (FDM) software provided, the driver is automatically installed with the PC software.

**i** The driver can be installed directly from the DVD without first having to copy the files to the PC.

**Changing the USB-B mode to "Ethernet over USB" (panel version)**

Communication can be established only if the device has been configured accordingly.

1. Supply power to the device, restart and wait for start screen.
2. Open dropdown menu under **"Setup → Advanced setup → Communication → Function USB-B"**.
3. "Always USB" option: USB-B is always set to Standard USB.
4. "Always Ethernet over USB" option: Ethernet over USB is always set.
5. "By user input" option: A prompt for the mode (option) appears once a USB cable is plugged in.

The device is now ready to establish a connection.

**Changing the USB-B mode to "Ethernet over USB" (DIN rail version)**

Communication can be established only if the device has been configured accordingly.



- ▶ Change the position of the DIP switch (9) from "USB-B" to "IP". The device is now set to "Always Ethernet over USB"

The device is now ready to establish a connection.

**Establishing communication**

1. Using a standard USB cable, connect the device at the USB-B interface to any of the PC's USB interfaces.
2. With "Always Ethernet over USB" function: The Web server can be started immediately.
3. With "By user input" function: Once the USB cable has been plugged into the device, the "Select USB function" dropdown menu appears. Then select "Ethernet over USB" on the device. The device returns the IP address.
4. Open the browser, enter <http://192.168.1.212> and follow the instructions from section →  64

The device is now ready to communicate with the Web server.

-  The IP address of the Web server via USB is set permanently to <http://192.168.1.212>
-  If the USB cable is already connected to a PC when the device starts up, there is no prompt even if the "By user input" option is selected. Instead, the previously selected functionality is used.

**8.1.4 Modbus RTU/TCP slave**

The device can be connected to a Modbus system via RS485 or Ethernet interface. The general settings for the Ethernet connection are made in the **Setup → Advanced setup → Communication → Ethernet** menu. Modbus communication is configured in the **Setup → Advanced setup → Communication → Modbus Slave** menu.

Up to 40 analog inputs and 20 digital inputs can be transmitted via Modbus and stored in the device.

Menu position	RTU (RS485)	Ethernet
Device address:	1 to 247	IP address manual or automatic
Baud rate:	9600/ <b>19200</b> /38400/57600/115200	-
Parity:	Even/Odd/ <b>None</b>	-
Stop bits:	1/2	-
Port:	-	502

**Transfer of values**

The actual Modbus TCP protocol is located between layer 5 to 6 in the ISO/OSI model.



To transfer a value, 3 registers of 2 bytes each (2-byte status + 4-byte float) or 5 registers of 2 bytes each (2-byte status + 8-byte double) are used.

-  For more information about Modbus, see the supplementary documentation.

**9 Commissioning**

**9.1 Function check**

Perform the following checks prior to commissioning:

- "Post-mounting check" checklist →  16.
- "Post-connection check" checklist →  31.

## 9.2 Switching on the measuring device

After the operating voltage is applied, the green LED lights up and the device is ready for operation.

If you are commissioning the device for the first time, program the setup as described in the following sections of the Operating Instructions.

If you are commissioning a device that is already configured or preset, the device starts measuring immediately as defined in the settings. The values of the channels currently activated are shown on the display.

 Remove the protective film from the display as this would otherwise affect the readability of the display.

## 9.3 Setting the operating language

Factory setting: English or ordered local language

**Version with stainless steel front and touchscreen, or when operating with the external USB mouse:**

Calling the main menu, configuring the operating language:

1. Press or click the "Menu" soft key at the bottom edge of the screen
2. The main menu appears on the display with the "Sprache/Language" option
3. To change the default language setting: press or click "Sprache/Language" and select the desired language from the drop-down menu
4. Use "Back" or "ESC" to quit the main menu



The operating language has been changed.

**Version with navigator and front interfaces:**

Calling the main menu, configuring the operating language:

1. Press the navigator
2. The main menu appears on the display with the "Sprache/Language" option
3. To change the set language: Press the navigator, turn the navigator to select the desired language and press the navigator to apply the change.
4. Use "Back" or "ESC" to quit the main menu

The operating language has been changed.

 The function  "Back" appears at the end of each menu/submenu.

Press "Back" briefly to go up one level in the menu structure.

To quit the menu immediately and return to the measured value display, press and hold "Back" (>3 sec.). The changes made are accepted and saved.

**DIN rail version:**

The operating language can only be changed via the Web server (Setup) or configuration software (DTM).

## 9.4 Configuring the measuring device (Setup menu)

Access to the setup is enabled when the device leaves the factory and can be locked in various ways e.g. by entering a 4-digit access code or by user administration.

When locked, basic settings can be checked but not changed. The device can also be put into operation and configured via the PC.

Device configuration options:

- Setup directly at the device (panel-mounted device only)
- Setup via SD card or USB stick by transferring the parameters stored on it
- Setup via Web server using Ethernet or Ethernet over USB
- Setup via FieldCare/DeviceCare configuration software

** Information on configuration using FieldCare/DeviceCare configuration software**

- Offline configuration: Most of the parameters are available (depending on the device configuration).
- Online configuration: Only parameters labeled "Online configuration" are available.  
→  130

### 9.4.1 Step-by-step: to the first measured value

**Procedure and necessary settings:**

1. Check the date/time in the main menu under **"Setup"** and set it if necessary
2. Make settings for the interfaces and communication in the main menu under **"Setup -> Advanced setup -> Communication"**
3. Create universal or digital inputs in the main menu under **"Setup -> Advanced setup -> Inputs -> Universal inputs/Digital inputs": Add input: select "Universal input x" or "Digital input x"** with which the input signal should be detected. Then select and configure the new input that has been created.
4. Activate relays or analog outputs (optional) in the main menu under **"Setup -> Advanced setup -> Outputs"**
5. Assign activated inputs to a group in the main menu under **"Setup -> Advanced setup -> Application -> Signal groups -> Group x"**
6. Use "Back" or "ESC" to quit the main menu. The changes made are accepted and saved.

The device is in the measured value display mode and displays the measured values.

### 9.4.2 Step-by-step: set or delete the limit values

**Procedure for setting limit values:**

1. Open the limit values in the main menu under **"Setup -> Advanced setup -> Application -> Limits"**
2. Add a limit value: select **"Yes"**
3. Select and configure **"Limit value x"**
4. Use "Back" or "ESC" to quit the main menu. The changes made are accepted and saved.

The device is in the measured value display mode and displays the measured values.

**Procedure for deleting limit values:**

1. Open the limit values in the main menu under **"Setup -> Advanced setup -> Application -> Limits"**
2. Delete a limit value: select **"Yes"**
3. Select the limit value to be deleted from the list
4. Use "Back" or "ESC" to quit the main menu. The changes made are accepted and saved.

The device is in the measured value display mode and displays the measured values.

### 9.4.3 Step-by-step: read HART® values (option)

**Procedure for reading measured values from a HART® device/sensor:**

1. Make settings for HART® communication (HART® master, connection attempts) under **"Setup -> Advanced setup -> Communication -> HART"**
2. Add new value to be read by selecting **"Add value -> Yes"**
3. Open the configuration for **"Value x"**
4. Select the physical interface to which the HART® device is connected **"Connection -> Channel x"**
5. Set the address of the connected device, the HART® value to be read and the channel identifier
6. Activate the universal input in the main menu under **"Setup -> Advanced setup -> Inputs -> Universal inputs"**
7. Select the **"HART"** signal type and assign the previously defined HART® values. Select using the channel identifier of the HART® value.
8. Other settings for the universal input are made in the same way as for standard analog inputs.
9. Assign activated inputs to a group in the main menu under **"Setup -> Advanced setup -> Application -> Signal groups -> Group x"**
10. Use "Back" or "ESC" to quit the main menu. The changes made are accepted and saved.

The device is in the measured value display mode and displays the measured values.

### 9.4.4 Step-by-step: HART® communication between an FDT Frame application (FieldCare) and a HART® device/sensor (optional)

The RSG45 HART® CommDTM enables HART® communication between a PC with an FDT Frame application and a HART® device. At this point, the RSG45 acts as a gateway/modem between the PC and the HART® devices that are connected to the HART® input cards of the RSG45. Communication between the PC and the RSG45 is via the TCP/IP protocol only.

**Procedure for establishing a connection:**

1. Start RSG45 HART® CommDTM in the FDT Frame application
2. Set the communication parameters, IP address of Memograph M RSG45, port for HART® communication and scan range (scan range 0 for a point-to-point connection)
3. Open the **"Create network"** menu to call up the **"Select communication channel"** dialog field to select the channel
4. Tick the check box beside the slot/channel to which one or more HART® devices are connected. Select **"OK"** to confirm the menu and start the scan.
5. All HART® devices that are found are displayed in the FDT Frame application and can now be accessed.

 Detailed help is provided with the RSG45 HART® CommDTM.



### 9.4.5 Device setup

In the **"Setup"** menu and in the **"Advanced setup"** submenu, you will find the **most important** settings for the device:

Parameter		Possible settings	Description
Change date/time		UTC time zone dd.mm.yyyy hh:mm:ss	Change the date and time.
Advanced setup			Advanced settings for the device e.g. system settings, inputs, outputs, communication, application etc.
	System		Basic settings that are needed to operate the device, (e.g. date/ time, security, memory management, messages, etc.)
	Inputs		Settings for the analog and digital inputs.
	Outputs		Settings only required if outputs (e.g. relays or analog outputs) are to be used.
	Communication		Settings required if the USB, RS232/RS485 or Ethernet interface of the device is to be used (PC operation, serial data export, modem operation, etc.).   The different interfaces (USB, RS232/RS485, Ethernet) can be operated in parallel. However, simultaneous use of the RS232 and RS485 interface is not possible.
	Application		Various application-specific settings (e.g. group settings, limit values, etc.).

 For a detailed overview of all the operating parameter, please refer to the Appendix of the Operating Instructions. →  130

### 9.4.6 Setup via SD card or USB stick

An existing device configuration ("Setup data" \*.DEH) from another Memograph M RSG45 or from FieldCare/DeviceCare can be uploaded directly to the device.

**Import new setup directly at the device:** The function used to load the setup data can be found in the main menu under **"Operation -> SD card (or USB stick) -> Load setup -> Select directory -> Next"**.

 In the case of the DIN rail version, the setup can only be uploaded to the device using an SD card.

### 9.4.7 Setup via Web server

To configure the device via the Web server, connect the device to a PC via Ethernet (or Ethernet over USB).

Please observe the information and communication settings for Ethernet (or Ethernet over USB) and the Web server under →  43.

 To configure the device via a Web server, Administrator or Service authentication is required. ID and password administration is performed in the main menu under **"Setup -> Advanced setup -> Communication -> Ethernet -> Configuration Web server -> Authentication"**.

ID default value: admin; Password: admin

Note: The password should be changed during commissioning!

If security settings are according to "FDA 21 CFR Part 11", you must have Administrator rights to configure the device via a Web server.

## Establishing a connection and setup

### Procedure for setting up a connection:

1. Connect the device to the PC via Ethernet (or Ethernet over USB).
2. Start the browser on the PC; enter the IP address: `http://<IP address>` to open the Web server for the device. Note: Leading zeros in IP addresses must not be entered (e.g. enter 192.168.1.11 instead of 192.168.001.011).
3. Enter the ID and password, and confirm each by clicking "OK" (see also the "Web server" section of the Operating Instructions →  64)
4. The Web server shows the instantaneous value display of the device. In the Web server taskbar, click **"Menu -> Setup -> Advanced setup"**.
5. Start the configuration

### Procedure for establishing a connection with the DIN rail version:

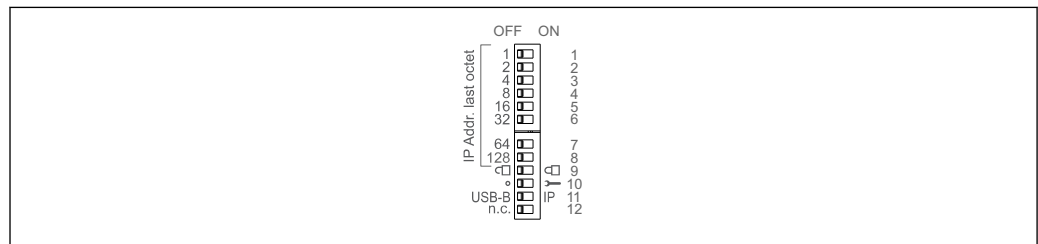

A0036815

### Version 1: via Web server/USB (requires a USB driver)

1. Set DIP switch 11 (USB-B/IP) to IP (ON)
2. Connect the USB and open the Web server using the Web browser (IP 192.168.1.212)
3. Configure the device under **"Expert -> Communication -> Ethernet"** (fixed IP address or DHCP)

 DIP switches 10 and 11 should not be set to ON simultaneously. In this case, only Ethernet or USB may be connected.

DHCP: The IP address assigned by DHCP is determined under **"Network"** (the device must be connected via Ethernet).

If DIP switches 1 to 8 are all set to ON or OFF, software addressing is active. In all other cases hardware addressing is active. The first 3 octets are therefore used by the software IP address (DHCP = off). The last octet must be configured via the DIP switches.

The USB driver must be installed.

If the position of DIP switch 11 (USB-B/IP) is changed, the USB cable must be disconnected from the device for at least 10 seconds.

### Procedure for establishing a connection with the DIN rail version:

#### Version 2: via DTM/USB

1. Set DIP switch 11 (USB-B/IP) to USB-B (OFF)
2. Connect the USB

3. Open the DTM (offline parameterization) and configure the device under **"Expert -> Communication -> Ethernet"** (fixed IP address or DHCP)

 DIP switches 10 and 11 should not be set to ON simultaneously. In this case, only Ethernet or USB may be connected.

DHCP: The IP address assigned by DHCP can be viewed in the online configuration under **"Diagnostics -> Device information -> Ethernet"** (the device must be connected by Ethernet).

If DIP switches 1 to 8 are all set to ON or OFF, software addressing is active. In all other cases hardware addressing is active. The first 3 octets are therefore used by the software IP address (DHCP = off). The last octet must be configured via the DIP switches.

The PC must be configured correctly (see also the procedure for "Point-to-point connection")

The USB driver must be installed.

If the position of DIP switch 11 (USB-B/IP) is changed, the USB cable must be disconnected from the device for at least 10 seconds.

### Procedure for establishing a connection with the DIN rail version:

#### Version 3: via Ethernet

1. Set DIP switch 10 (Service) to ON
2. Connect the Ethernet cable (point-to-point connection; a crossover cable is not required)
3. Now configure the device via the IP address 192.168.1.212 by Web server or DTM (see version 1 and 2)
4. Following configuration, set DIP switch 10 back to OFF. It is now possible to communicate with the device via the configured IP address.

 DIP switches 10 and 11 should not be set to ON simultaneously. In this case, only Ethernet or USB may be connected.

With this method it is not possible to determine which DHCP address the device has received. DHCP should be disabled for this reason. Alternatively, a network administrator must determine the IP address via the MAC address.

The PC must be configured correctly (see also the procedure for "Point-to-point connection")

The USB driver must be installed.

If DIP switches 1 to 8 are all set to ON or OFF, software addressing is active. In all other cases hardware addressing is active. The first 3 octets are therefore used by the software IP address (DHCP = off). The last octet must be configured via the DIP switches.

Continue with device configuration in accordance with the Operating Instructions for the device. The complete Setup menu i.e. all of the parameters listed in the Operating Instructions, can also be found on the Web server. After configuration, accept the setup with **"Save settings"**.

 Procedure to establish a direct connection via Ethernet (point-to-point connection):  
→  62

**NOTICE**

**Undefined switching of outputs and relays**

► When configuring using a Web server, the device may adopt undefined states! This may result in the undefined switching of outputs and relays.

**i** An existing device configuration ("Setup data" \*.DEH) from another Memograph M RSG45 or from FieldCare/DeviceCare can be uploaded directly to the device via the Web server.

**Procedure for uploading a new setup via the Web server:**

1. Establish a connection to the device via the Web server → 50
2. Click **"Data management -> Import device settings"** in the Web server function bar
3. Select the setup file and press **"OK"** to confirm
4. The file is transferred, checked and accepted
5. Once the device settings are accepted, information to this effect is displayed in the Web server.

**9.4.8 Setup via FieldCare/DeviceCare configuration software**

To configure the device using the configuration software, connect the device to your PC via USB or Ethernet.

**i** Download at: [www.endress.com/download](http://www.endress.com/download)

**Establishing a connection and setup**

Continue with device configuration in accordance with the Operating Instructions for the device.

**i Information on configuration using FieldCare/DeviceCare configuration software**

- Offline configuration: Most of the parameters are available (depending on the device configuration).
- Online configuration: Only parameters labeled "Online configuration" are available. → 130

**NOTICE**

**Undefined switching of outputs and relays**

► During configuration using the configuration software, the device may assume undefined statuses! This may result in the undefined switching of outputs and relays.

**9.5 Advanced settings (Expert menu)**



**i** The Expert menu is protected by the code "0000". If an access code is set up under **"Setup -> Advanced setup -> System -> Security -> Protected by -> Access code"**, this must be entered here.

If security settings are according to "FDA 21 CFR Part 11", you must be logged in as a user with Administrator rights to access the Expert menu.

The **"Expert"** menu contains **all** of the device settings:

Parameter	Possible settings	Description
Direct access	000000-000	Direct access to parameters (fast access)
System		Basic settings that are needed to operate the device, (e.g. date/ time, security, memory management, messages, etc.)
Inputs		Settings for the analog and digital inputs.

Parameter	Possible settings	Description
Outputs		Settings only required if outputs (e.g. relays or analog outputs) are to be used.
Communication		Settings required if the USB, RS232/RS485 or Ethernet interface of the device is to be used (PC operation, serial data export, modem operation, etc.).  The different interfaces (USB, RS232/RS485, Ethernet) can be operated in parallel. However, simultaneous use of the RS232 and RS485 interface is not possible.
Application		Define various application-specific settings (e.g. group settings, limit values, etc.).
Diagnosis		Device information and service functions for a quick device check.

 A detailed overview of all the operating parameters is provided in the appendix at the end of the Operating Instructions. →  130

## 9.6 Configuration management

 You can save the setup data ("Configuration") to an SD card or a USB stick, to a PC drive via the Web server, or store them in a database using the configuration software. This allows additional devices to be configured very easily using the same settings.

**Save setup:** The function used to save the setup files can be found in the main menu under **"Operation -> SD card (or USB stick) -> Save setup"**.

### CAUTION

**If the SD card or USB stick are removed directly:**

Risk of data loss on SD card or USB stick

- ▶ To remove the SD card or the USB stick, always select **"Operation -> SD card (or USB stick) -> Safe removal"** in the main menu!

**Procedure for saving a setup via the Web server:**

1. Establish a connection to the device via the Web server →  50
2. Click **"Data management -> Save device settings"** in the Web server function bar
3. Select the setup file
4. Transfer the file
5. Verify and accept
6. Once the device settings are accepted, information to this effect is displayed in the Web server.

 The function for saving the setup data must be enabled at the device for the Web server under **"Setup -> Advanced setup -> Communication -> Ethernet -> Configuration Web server; Setup -> Yes"**.

## 9.7 Simulation

Various functions/signals can be simulated for test purposes here.

**NOTICE**

**Selecting simulation: Simulation of the relays and the WebDAV client can be found in the main menu under "Diagnostics -> Simulation". The simulation of the measured values can be found in the main menu under "Expert -> Diagnostics -> Simulation".** Only the simulated values are recorded during simulation. The simulation is recorded in the event logbook.

- ▶ Do not start simulation if measured value recording must not be interrupted!

## 9.8 Access protection and security concept

To protect the setup from unauthorized access following commissioning, there are many options to ensure access protection to the setup settings and the user entries. Access and authorizations can be configured and assigned passwords.

Hardware protection (digital input, DIP switch) and password protection can be used redundantly.

 The user of the device is responsible for access protection and the security concept. In addition to the device functions listed, user policies and procedures, in particular, must also be applied (e.g. password allocation, password sharing, physical access barriers, etc.).

The following protection options and functionalities are available:

- Protection per control input
- Protection via access code
- Protection via user roles
- Protection via user administration according to "FDA 21 CFR Part 11"
- Protection via DIP switches (DIN rail version)

### *Overview of access protection and security concept*

Access protection	User	Setup changes	Description
Open access	-	Permitted	No protection, not recommended, all setup and system settings are accessible.
Control input	-	Permitted	Access protection via digital input (e.g. via key switch), all setup and system settings are accessible if input actuated.
Access code	-	Permitted	Access protection via access code, access authorization (distribution of access code) must be defined via (in-house) regulations and securely controlled. All setup and system settings can be accessed after entering the access code.
Password-protected user roles			Protection levels and access authorization can be defined via 3 levels of access (user roles). Access authorization (distribution of passwords) must be defined via (in-house) regulations and securely controlled.
	Administrator	Permitted	Access protection via administrator password, all setup and system settings can be accessed after entering the password.
	Service	Permitted	Access protection via service password, all setup and system settings can be accessed after entering the password, advanced functions (e.g. preset) are possible in the service mode.
	Operator	Locked	All setup and system settings are locked, access to device information and display values after entering the password.
FDA 21 CFR Part 11 User Administration password-protected			Protection levels and access authorization can be defined via 5 levels of access (in accordance with FDA 21 Part 11 User Administration). Access authorization (distribution of passwords) must be defined via (in-house) regulations and securely controlled. The user logs in with his user name and the password he has been assigned. All actions are logged in a tamper-proof manner in the audit trail (logbook) in accordance with the FDA.

Access protection	User	Setup changes	Description
	Administrator	Permitted	No protection, all setup and system settings are freely accessible.
	Main user	Locked	Setup and system settings are locked. Limit value changes, data entries, confirmation of registration, etc. are allowed.
	User Level 1	Locked	Setup, limit value and system settings are locked, data entries (e.g. text entries), registration confirmation, etc. are allowed.
	User Level 2	Locked	Data entries and setup, limit value and system settings are locked. Display function for device status and measured values, registration confirmation are allowed.
	User Level 3	Locked	No data entries possible, display function only for device status and measured values.
DIP switches (DIN rail device)	-	Permitted	Access protection via DIP switch at front (limited protection); protection level can be increased by additional external measures (e.g. locked control cabinet). All setup and system settings can be accessed when the DIP switch is set to "Access permitted".

In order to change any parameter, the correct code must first be entered or the device must be unlocked using the control input.

**Setup lock via control input:** The settings for the control input can be found in the main menu under "**Setup -> Advanced setup -> Inputs -> Digital inputs -> Digital input X -> Function: Control input; Action: Lock setup**".



It is preferable to lock the setup using a control input.

**Setting up an access code:** The settings for the access code can be found in the main menu under "**Setup -> Advanced setup -> System -> Security -> Protected by -> Access code**". Factory setting: "Open access", i.e. modifications can always be made.



Make a note of the code and store in a safe place.

**Setting up user roles:** The settings for the user roles (operator, admin and service) are provided in the main menu under "**Setup -> Advanced setup -> System -> Security -> Protected by -> User roles**". Factory setting: "Open access", i.e. modifications can always be made.



The passwords should be changed during commissioning.

Make a note of the code and store in a safe place.

**Setting up user administration according to "FDA 21 CFR Part 11":** The settings for user administration can be found in the main menu under "**Setup -> Advanced setup -> System -> Security -> Protected by -> FDA 21 CFR Part 11**". Factory setting: "Open access", i.e. modifications can always be made.

## 9.9 HTTPS Web server setup

To operate the HTTPS Web server, an X.509 certificate and a suitable private key must be installed on the device. For security reasons, installation is via a USB stick only.



The certificate that is preinstalled on the device when delivered from the factory should not be used!



Server certificates cannot be installed via the "USB stick/import SSL certificates" function!

### Prerequisites

Private key:

- X.509 PEM file (Base64 encoded)
- RSA key with max. 2048 bit
- May not be password-protected

Certificate:

- X.509 file (Base64 encoded PEM or binary DER format)
- V3 incl. extension required
- Signed by a certification authority (CA) or sub-certification authorities (recommended), self-signed where necessary.

Certificate and private key can be created or converted using openssl (<https://www.openssl.org>) for example. Contact your IT administrator to create the corresponding files.

 Tip: More information on this topic is provided in our How To Videos under <https://www.youtube.com/endresshauser>

Installation:

1. Copy the private key onto a USB stick into the root directory. File name: **key.pem**
2. Copy the certificate onto a USB stick into the root directory. File name: **cert.pem** or **cert.der**
3. Connect the USB stick to the device. The private key and the certificate are installed automatically. The installation is logged in the event logbook.
4. Remove the USB stick using the **"Safe removal"** function

### Notes:

- In the DIN rail version, the device will automatically copy any data not yet saved to the USB stick
- The device may have to be restarted for the browser to use the new certificate
- Delete the private key from the USB stick following installation
- Keep the private key in a safe place
- Use the private key and the certificate for one device only
- To prevent unauthorized use, it is possible to disable the USB A port on the device. In this way, an attacker cannot replace the certificate or the private key ("Denial of Service"). If necessary, install a perimeter guard to prevent access to the device.

### Checking certificates

You can check the certificate via **"Main menu -> Diagnostics -> Device information -> SSL certificates"**. For this purpose, select the **"Server certificate"** point under the certificate.

 Replace the certificate in good time before it expires. The device will display a diagnostic message 14 days before the certificate expires.

### Uninstalling certificates and the private key

You can check the certificate via **"Main menu -> Diagnostics -> Device information -> SSL certificates"**. For this purpose, select the **"Server certificate"** point under the certificate. You can delete the certificate here.

 In this case, the preinstalled certificate is reused.

### Using self-signed certificates

 Self-signed certificates must be stored in the PC's certificate memory under "Trusted Root Certification Authorities" so that the browser does not display a warning.

Alternatively, an exception can be saved in the browser.





## 9.10 TrustSens Calibration Monitoring

 Available in conjunction with iTHERM TrustSens TM371 / TM372.

Application package :

- Up to 20 iTHERM TrustSens TM371 / TM372 devices can be evaluated via the HART interface
- Self-calibration data displayed on screen or via the Web server
- Generation of a calibration history
- Creation of a calibration protocol as an RTF file directly at the RSG45
- Evaluation, analysis and further processing of the calibration data using "Field Data Manager" (FDM) analysis software

Enable the function: Self-calibration monitoring is switched on under **Expert** → **Application** → **Monitor self-calibration**.

 For more information, see additional Operating Instructions →  BA01887R

## 10 Fulfilling requirements in accordance with "FDA 21 CFR Part 11"

### 10.1 General notes

Before applying electronic signatures the

Office of Regional Operations (HFC-100)

5600 Fishers Lane

Rockville, MD 20857

USA

is to be informed, by means of an informal letter with handwritten signature, that the company intends to use electronic documents/signatures in future. Administrators and users must be instructed / trained in accordance with 21 CFR 11 or must already possess the relevant knowledge or qualifications. Commercial software used in electronic recording systems in accordance with 21 CFR 11 must be validated. The suitability of the device and the associated PC software (incl. operating system) for the application in question must be specified, validated, and documented (e.g. with regard to data confidentiality, printout of the device parameters, security backup of the set parameters, assignment of access authorizations in the PC software, suitability of the software used for commercial purposes – such as operating system, etc.).

The identity of the relevant person must be verified before assigning / determining the electronic signature (or elements of this electronic signature, e.g. unique ID / initialization password). The administrator must ensure and document the uniqueness of the ID and its correct assignment to the relevant person. Electronic signatures may only be used by authorized users. They must not be passed on to third parties. Administrators and users must undertake not to misuse their user IDs and passwords (including initialization passwords).

Written procedural instructions, which make individuals responsible for all actions carried out using their electronic signature, must be drawn up and observed so as to provide a deterrent mechanism for the falsification of documents and signatures.

Suitable checks of system documentation must be made (distribution, access, and use of documentation for system operation and maintenance). Revision and change control procedures must be implemented for the system documentation in which the chronological order of the development and change to system documentation is documented. The system is not intended for use in Internet applications/open systems.

**NOTICE****The user is responsible for observing the following instructions for ensuring compliance with FDA 21 CFR Part 11:**

- ▶ The scope of application for this FDA 21 CFR Part 11 evaluation refers to the Memograph M RSG45 and the associated Field Data Manager (FDM) PC software, which have been produced and tested by the manufacturer. The overall system must be subjected to a final evaluation by the end user.
- ▶ Recordings from the device and the associated PC software in accordance with "FDA Guidance for Industry: Computerized Systems Used in Clinical Investigations: 2007" cannot be used for clinical studies.
- ▶ In order to satisfy the requirements of FDA 21 CFR Part 11 with regard to the electronic signature, the device may only be read out with the associated Field Data Manager (FDM) PC software.
- ▶ The device and the associated PC software do **not** take into account the requirements of FDA 21 CFR Part 11, §11.30 for "Open systems". Operation within the context of an open system must be excluded.
- ▶ The operator must take suitable management precautions to prevent the loss of password access data/authentication data.
- ▶ The printer must be connected correctly and its long-term function guaranteed, even in the event of local changes (e.g. network printer).
- ▶ Due to the aging of components, the device must be calibrated at regular intervals.
- ▶ Regular maintenance must also be carried out.
- ▶ Measures must be taken to prevent the device from being moved (e.g. physical protection).
- ▶ No data will be recorded in the event of a power failure.
- ▶ The battery buffer for the backup clock is checked and, where necessary, a warning issued.
- ▶ Wireless transmission may not be used between the device and the PC software. In the case of wired transmission, operation is only permitted within the closed company network. This must be checked during the validation of the complete system.

**NOTICE****The user is responsible for observing the following instructions for ensuring compliance with FDA 21 CFR Part 11:**

Requirements for connected hardware components:

- ▶ Associated hardware components (e.g. a PC connected to the device) are part of the system but must be provided by the user. Backup measures designed to prevent hard disk defects or a memory overrun are the responsibility of the user.
- ▶ Wired peripherals, such as a USB keyboard for the device or a keyboard for the PC, can be scanned in using "Keylogger". It is the user's responsibility to prevent the use of so-called "sniffers".

## 10.2 Important device settings

### NOTICE

In order to satisfy the requirements from 21 CFR 11, certain device functions are required. In particular, some user administration settings must be made:

- ▶ Activate user administration and password protection according to FDA 21 CFR Part 11: In the main menu go to **"Setup -> Advanced setup > System -> Security -> Protected by -> FDA 21 CFR Part 11"**
- ▶ Create a user: In the main menu go to **"User administration -> Create user account"** to create a new user.
- ▶ Make general user administration settings and define password rules: In the main menu go to **"User administration -> General"**. Recommendation: Password valid for 60 days in order to prevent it from becoming too familiar to the user.
- ▶ Assign the permitted rights to users in the main menu under **"User administration -> General -> User rights"**
- ▶ All changes to the device are automatically recorded in the event logbook. The event logbook can be opened from the main menu under **"Diagnostics -> Event logbook"**

### NOTICE

The user is responsible for observing the following instructions for ensuring compliance with FDA 21 CFR Part 11:

Requirements for the device:

- ▶ The device must be regarded as a closed system.
- ▶ Administrator rights are required to change the configuration. The device must be locked via hardware protection (terminal cover) and a digital input assigned. Changes are documented in the event logbook / audit trail. The event logbook can be opened from the main menu under **"Diagnostics -> Event logbook"**.
- ▶ User administration with ID and password must be active.
- ▶ All changes must always be documented with the user's name in the event logbook. It is essential that user administration is active for this. All users must be created accordingly under User administration.
- ▶ All settings relating to password complexity and validity period are the responsibility of the administrator.
- ▶ During commissioning, the special requirements for the admin role must be taken into account (stricter password rules). User administration can only be disabled by the administrator. Under certain circumstances the administrator may lock users out of the system or sabotage user administration.
- ▶ The initial password set by the administrator must be changed on the first login (configurable).
- ▶ If the wrong password is entered repeatedly (max. number of attempts is adjustable), access is blocked and an alarm can be sent by e-mail.
- ▶ After setting up/using the device, the user must log out. Automatic logout after a configurable time must be activated.
- ▶ Communication interfaces can be blocked by the administrator. The interface for using the modem must be switched off.
- ▶ Hardware locking must be performed for the device update. This ensures that only the administrator can perform a firmware update.
- ▶ Any manipulation of the time synchronization is the responsibility of the user.
- ▶ In order to prevent a loss of data, the data must be read out regularly from the memory.
- ▶ Administrator rights are required in order to delete the internal memory. A hardware lock can also be used to prevent the memory from being deleted.
- ▶ The device produces a diagnosis list in which faults are documented. The diagnosis list must be checked regularly; this can be done in the main menu under **"Diagnostics -> Diagnosis list "**.
- ▶ Proof testing of the error log is recommended; this is done from the main menu under **"Diagnostics -> Device information -> Error log"**.

**NOTICE**

**The user is responsible for observing the following instructions for ensuring compliance with FDA 21 CFR Part 11:**

Requirements for the external memory:

- ▶ The external storage medium (SD card/USB stick) must only be removed using the function **"Operation -> SD card/USB stick -> Remove safely"**.
- ▶ In contrast to the protected data format, which features CRC16 protective measures, the stored data can be manipulated when using the open format (\*.csv).
- ▶ In order to prevent unauthorized access (e.g. through theft), the external memory can also be disabled or removed.

### 10.3 Important settings in the Field Data Manager (FDM) PC software

**NOTICE**

**In order to satisfy the requirements according to FDA 21 CFR Part 11, certain functions are required in the associated PC software. In particular, some user administration settings must be made.**

- ▶ Use only operating systems with user administration (e.g. MS Windows® 2000/XP/Vista/7/8).
- ▶ Create an administrator: Create an administrator under **"Extras -> User administration"**.
- ▶ Activate user administration and password protection according to FDA 21 CFR Part 11: Under **"Extras -> Settings -> User administration"** select **"Activate user management"** and **"Password protection in compliance with FDA 21 CFR Part 11"**. The software applies the settings following a restart.
- ▶ Additional users can now be created under **"Extras -> User administration"** with the corresponding access roles.
- ▶ All changes made to the software are recorded in the "Audit trail". This can be opened via **"Extras -> Audit trail"**.
- ▶ Where appropriate, use the high-performance automatic functions of the PC software (e.g. automatic read out, automatic backup function, automatic e-mail alert).
- ▶ **Note:**Detailed instructions can be found on the DVD provided with the PC software.

**NOTICE**

**The user is responsible for observing the following instructions for ensuring compliance with FDA 21 CFR Part 11:**

- ▶ Modem operation cannot be implemented as a closed system.
- ▶ User administration must be active in order to record the user names in the audit trail.
- ▶ The password must be changed on the first login.
- ▶ If the administrator forgets the password, a master password, which is only valid for a limited period, may be used. Access is granted to the user on request and following authorization.
- ▶ If a user does not log out, an automatic lockout (screensaver) is activated via the Windows® system setting.
- ▶ It is possible to use the Field Data Manager PC software without identification or password protection, but this is not compliant with FDA 21 CFR Part 11.
- ▶ The ending of the automatic system service must be controlled via Windows® user rights.
- ▶ Since the PC date/time is used for the audit trail, it is theoretically possible to manipulate the time stamp. This must be prevented by the user by means of Windows® user rights.
- ▶ Regular backups and preventive maintenance (e.g. by means of software updates) must be carried out.
- ▶ It is important to ensure that no data can be intercepted or manipulated during communication between the device and the database.

# 11 Operation

The "Operation" menu is geared towards the tasks and activities of the operator. It contains all the parameters that are needed in ongoing operation. Historical values and analyses, for example, can be displayed in the "Operation" menu and display settings can be made. Any settings made for the local display have no effect on the measurement section or the configured device parameters, however.

The device's simple operating concept and the integrated help function enables you to perform operation for many applications without the need for hardcopy operating instructions.

## 11.1 Reading-out and changing the Ethernet setting address

To establish communication with the device via Ethernet, the following settings must be known or modified where necessary:

**Display IP/MAC address** (only if DHCP is enabled): For the device's IP or MAC address, see the main menu under "**Diagnostics -> Device information -> Ethernet**".

**Display/change Ethernet settings:** For the device's Ethernet settings, see the main menu under "**Setup -> Advanced setup -> Communication -> Ethernet**".

 In the case of the DIN rail version: These settings can only be accessed by Web server under "**Menu -> Diagnostics -> Device information -> Ethernet**".

**Procedure to establish a direct connection via Ethernet (point-to-point connection):**

1. Configure the PC (depends on operating system): e.g. IP address: 192.168.1.1; subnet mask: 255.255.255.0; gateway: 192.168.1.1
2. Disable DHCP on the device
3. Make communication settings on the device: e.g. IP address: 192.168.1.2; subnet mask: 255.255.255.0; gateway: 192.168.1.1

 A crossover cable is not required.

## 11.2 Reading off the device locking status

If setup is locked via a control input, a padlock symbol  appears on the top right of the screen. The setup must first be unlocked via the control input before device parameters can be edited.

**Setup lock via control input:** For the settings for the control input, see the main menu under "**Setup -> Advanced setup -> Inputs -> Digital inputs -> Digital input X -> Function: Control input; Action: Lock setup**".

If setup is locked via the access code, all the operating parameters can be displayed, and can also be edited as soon as the access code is entered.

 In the case of the DIN rail version: These settings can only be accessed by Web server under "**Setup -> Advanced setup -> Inputs -> Digital inputs -> Digital input X -> Function: Control input; Action: Lock setup**".

### 11.3 Reading off measured values (display devices)

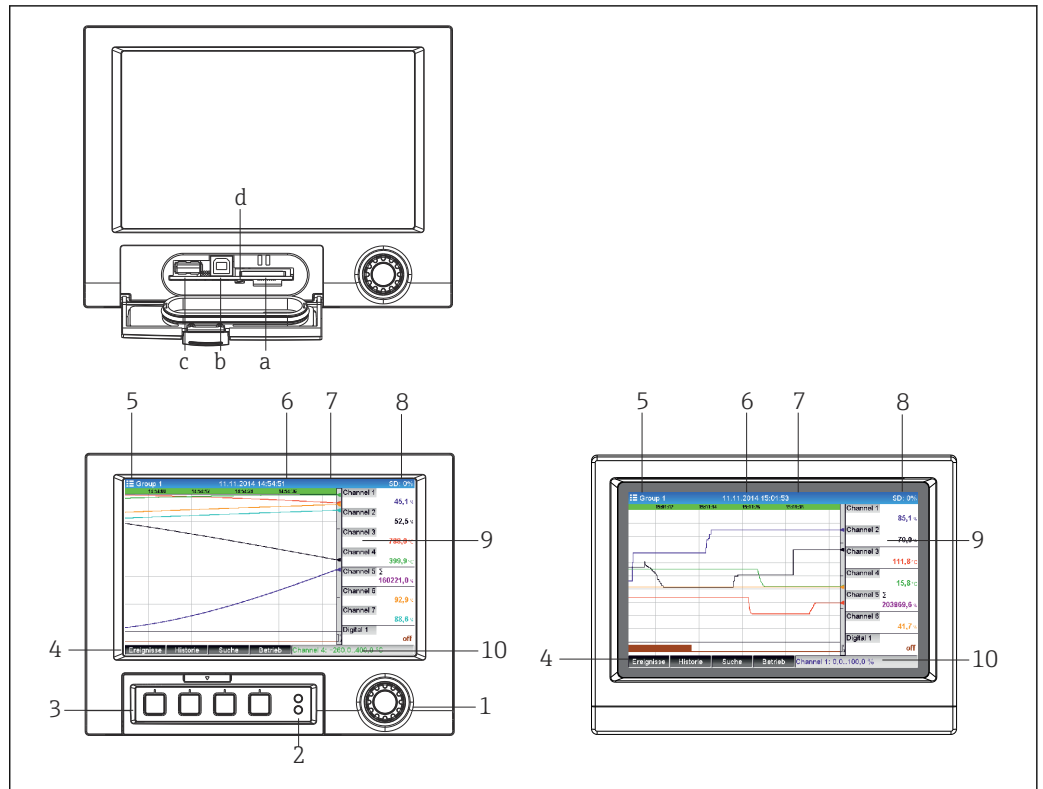

16 Device front (left: version with navigator and front interfaces; right: version with stainless steel front and touchscreen)

- a Slot for SD card
- b USB B socket "Function" e.g. to connect to PC or laptop
- c USB A socket "Host" e.g. for USB memory stick, external keyboard, barcode reader or printer
- d Yellow LED for read/write access to the SD card
- 1 Navigator: press briefly to open the main menu and confirm messages (=Enter); press for longer to open the online help
- 2 Green LED (top) lit: power supply present. Red LED (bottom) flashing: maintenance required
- 3 Variable "soft keys" 1 to 4 (from left to right)
- 4 Function indicator of the "soft keys"
- 5 Header: group name, analysis type
- 6 Header: current date/time
- 7 User ID (when function is active)
- 8 Header: alternating display indicating the percentage space on the SD card or USB stick that has already been used. The display alternates between displaying memory information and status symbols.
- 9 Area for measured value display (e.g. curve display). Display of current measured values and the status in the event of an error/alarm condition. In the case of counters, the type of counter is displayed as a symbol.
- 10 Status bar

**i** An overview of all the symbols and icons is provided in the "Operation options" section. → 38

**i** If a measuring point has limit value status, the corresponding channel identifier is highlighted in red (quick detection of limit value violations). During a limit value violation and device operation, the acquisition of measured values continues uninterrupted.

**i** Information on how to rectify a problem if an error occurs is provided in the "Troubleshooting" section. → 82

## 11.4 Web server

The device features an integrated Web server, which enables access via Ethernet (or Ethernet over USB). The Web server is used for convenient device commissioning and configuration and to visualize measured values. Access is possible from any access point when the device is connected to an Ethernet network. An appropriate IT infrastructure, security measures etc. must be implemented in accordance with the requirements of the plant. Point-to-point access via Web server and Ethernet via USB is particularly well-suited for service purposes.

While the DIN rail device version can be operated and configured using the FieldCare and DeviceCare software tools, it is preferably configured and operated via the Web server.

Activation of the Web server in the menu **Setup** → **Advanced setup** → **Communication** → **Ethernet** → **Web server** → **Yes** or menu **Expert** → **Communication** → **Ethernet** → **Web server** → **Yes**

The Web server port is preset to 80. The port can be changed in the **Expert** → **Communication** → **Ethernet** menu.

 If the network is protected by a firewall, the port may need to be activated.

The following web browsers are supported:

- MS Internet Explorer 11 and higher
- MS Edge
- Mozilla Firefox 52.1.0 and higher
- Opera 12.x and higher
- Google Chrome 66 and higher

 A minimum resolution of 1920x1080 (full HD) is recommended.

In order to use the full functionality of the Web server, it is recommended that the latest version of the browser is used. To access the device via a Web server, you must have Administrator, Service or Operator authentication →  54

 The Web server is not optimized for visualization on smartphones.

When delivered, the following default values are set for the user roles in the device and Web server:

- ID: admin; password: admin
- ID: service; password: service
- ID: operator; password: operator

FDA role-based access protection is not pre-defined. Proceed as follows: perform a basic setup logged in as "admin" and then enable "FDA compliant" access protection.

 Note: Passwords should be changed during commissioning!

The ID and password can be changed in the main menu under "**Setup** → **Advanced setup** → **Communication** → **Ethernet** → **Configuration Web server** → **Authentication**".

### 11.4.1 Access to the Web server via HTTP (HTML)

When using an Internet browser, it suffices to enter the address **http://<IP address>** to display the information as HTML in the browser.

 Note: Leading zeros in IP addresses must not be entered (e.g. enter 192.168.1.11 instead of 192.168.001.011).

As in the case of the display, you can alternate between the display groups in the Web server. The measured values are automatically updated. In addition to the measured values, status and limit value flags are displayed.



### 11.4.2 Access to the Web server via XML

XML format is available in addition to HTML format and contains all measured values of a group. This can be integrated into additional systems as the user wishes.

The XML file is available in ISO-8859-1 (Latin-1) coding at **http://<IP address>/values.xml** (alternative: **http://<IP address>/xml**). However, some special characters, such as the Euro symbol, cannot be displayed in this file. Texts such as digital statuses are not transmitted.

 Note: Leading zeros in IP addresses must not be entered (e.g. enter 192.168.1.11 instead of 192.168.001.011).

 The decimal point is always displayed as a period in the XML file. All times are given in UTC. The time difference in minutes is noted in the following entry.

The structure of the channel values for the XML file is explained as follows:

```
<device      id="AI01IV" tag="Channel 1" type="INTRN">
  <v1>50.0</v1>
  <u1>%</u1>
  <vtime>20130506-140903</vtime>
  <vstslv1>0</vstslv1>
  <hlsts1>L</hlsts1>
  <param><min>0.0</min><max>100.0</max><hh></hh><hi></hi><lo></lo><ll></ll></
  param>
  <tag>Channel 1</tag>
  <man>Manufacturer</man>
</device>
```

Tag	Description
device id	Unique ID of measuring point
tag	Channel ident.
type	Data type (INTRN, MODBUS)
v1	Measured value of channel as a decimal value
u1	Unit of measured value
vtime	Date and time
vstslv1	Error level 0 = OK, 1 = warning, 2 = error
hlsts1	Limit value status H = upper limit value, L = lower limit value, LH = upper and lower limit value violation
param min max hh hi lo ll	Parameter (optional) Lower zoom Upper zoom Upper alarm limit Upper warning limit Lower warning limit Lower alarm limit
MAN	Manufacturer

### 11.4.3 Setup, operation and service via the Web server

**Establish a connection to the Web server:**

1. Connect the PC to the device via Ethernet (or Ethernet over USB)
2. Start the browser on the PC
3. Enter the device's IP address in the browser **http://<ip address>**
4. Log in with the ID and password

The startup screen of the Web server appears.

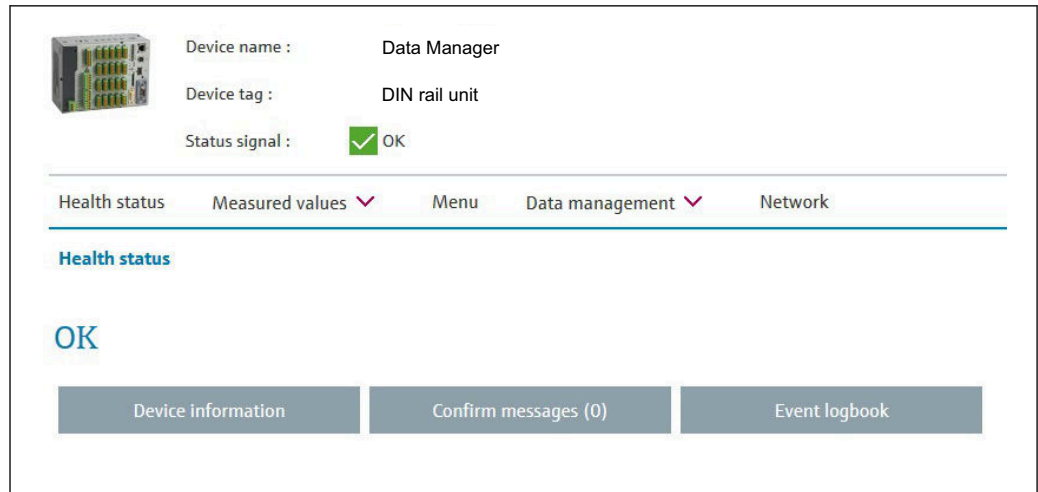

A0037114

General information regarding the **Device name**, **Device tag** and **Status signal** is displayed in the top section of the Web server. The following functions can be accessed in the middle of the screen:

**Health status – Measured values – Menu – Data management - Network.**

Clicking the functions calls up the following submenu. The submenus are closed by selecting "Cancel" or by clicking "Back" several times.

**Health status (advanced device status)**

Function	Description
Device information	Advanced device status, Ethernet settings, hardware configuration, device options, memory information, SSL certificate
Confirm messages	Submenu to confirm system messages
Event logbook	Submenu for the event logbook

**Measured values (choice of measured value display)**

Function	Description
Instantaneous values	Measured values are displayed as numerical instantaneous values, the signal groups can be selected as tabs here
Instantaneous values as curves	The measured values are displayed as curves
History	Displays a history of the measured values

**Menu**

The menu structure displayed in the Web server corresponds largely to the menu structure in the device → 📖 33

**Data management**

Update functions and parameters relating to the firmware, load/save setup, save setup as RTF, import SSL certificates

**Network**

Displays the Ethernet parameters (IP address, subnet mask, gateway, domain)

**Displays the current measured values and history data**

Under **Measured values** a selection window appears for **Instantaneous values – Instantaneous values as curves – History**. Click to display the corresponding display function.

**i** Current measured values can also be called up via the Web server without logging in with the address **http://<IP address>/iv**. Device configuration is **not** possible in this case, however.

Note: The browser must support HTML5.

Optional command parameters:

- Syntax: `http://<ip address>/iv?group=<x>&refresh=<y>`
- `group=<x>` where `x = 1 to 10`
- `refresh=<y>` where `y = 3 to 3600` in seconds

Note: Pay attention to lower and upper case if using an optional parameter.

This function can be disabled in the setup. If this function is disabled, the option to export instantaneous values to XML is also disabled for security reasons.

**Instantaneous values**

The current measured values are displayed in numerical format. Clicking the tabs displays the signal groups defined in the setup.

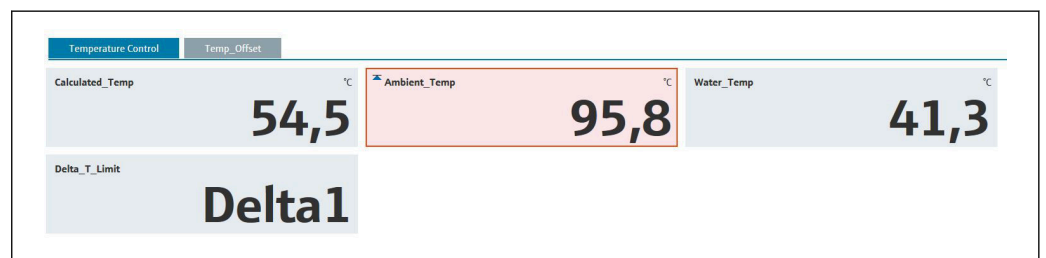

A0037118

**Instantaneous values as curves**

The current measured values are displayed as a curve and numerically over the time axis. The refresh rate can be set in a selection window. The display mode can be set to full screen. Clicking the tabs displays the signal groups defined in the setup.

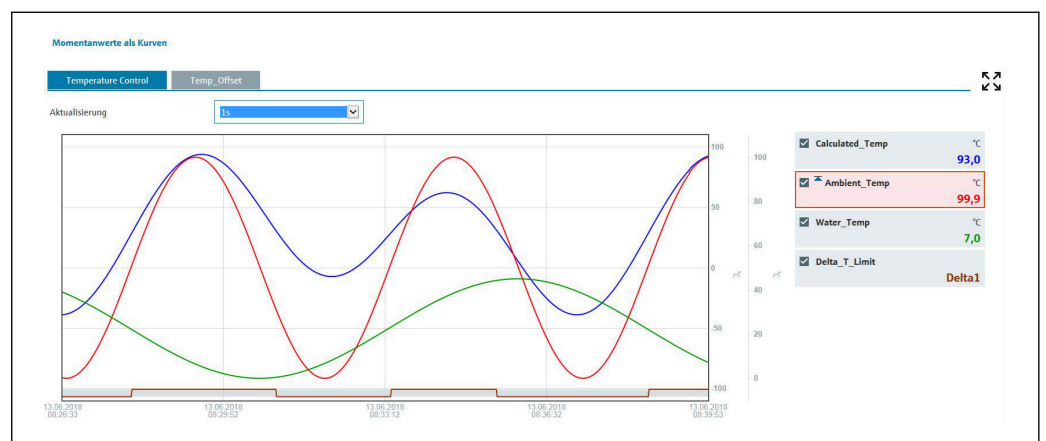

A0037117

**Display functions**

If the cursor is moved over one of the curves, the instantaneous value of the current point in the curve is displayed with the time stamp and unit. Channels can be displayed and hidden using the channel checkboxes in the legend.

### History (logged measured values)

Clicking the **History** button loads the data previously logged. This may take a few seconds depending on the data connection (USB, Ethernet, WLAN) and the number of measuring channels. The data for each channel is loaded to display the content of one screen. The logged (history) values are displayed as a curve and numerically over the time axis. The display mode can be set to full screen. Clicking the tabs displays the signal groups defined in the setup.

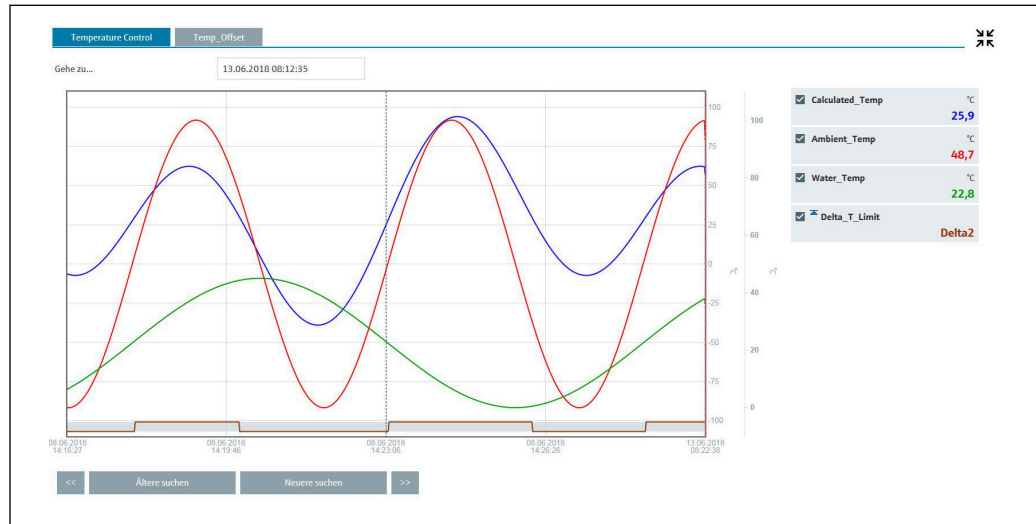

### Display functions

If the cursor is moved over one of the curves, the instantaneous value of the current point in the curve is displayed with the time stamp and unit. Channels can be displayed and hidden using the channel checkboxes in the legend.

Moving the dashed cursor line along the time axis updates the numerical display of the measured values accordingly (on right).

**Go to ...:** Enter a point in time. The history is reloaded. If you enter a time for which no measured values are available, the next possible time where measured values are available is displayed.

**Search older:** The information displayed moves half a screen to the left (displays older measured values). Press the << button to move the information one entire screen to the left (older measured values).

**Search newer:** The information displayed moves half a screen to the right (displays more recent measured values). Press the >> button to shift the information one entire screen to the right (more recent measured values).



Note: If no measured values were recorded for a certain range of time (e.g. as there was no power supply), this is indicated by a symbol at the top of the window. The curves jump accordingly.

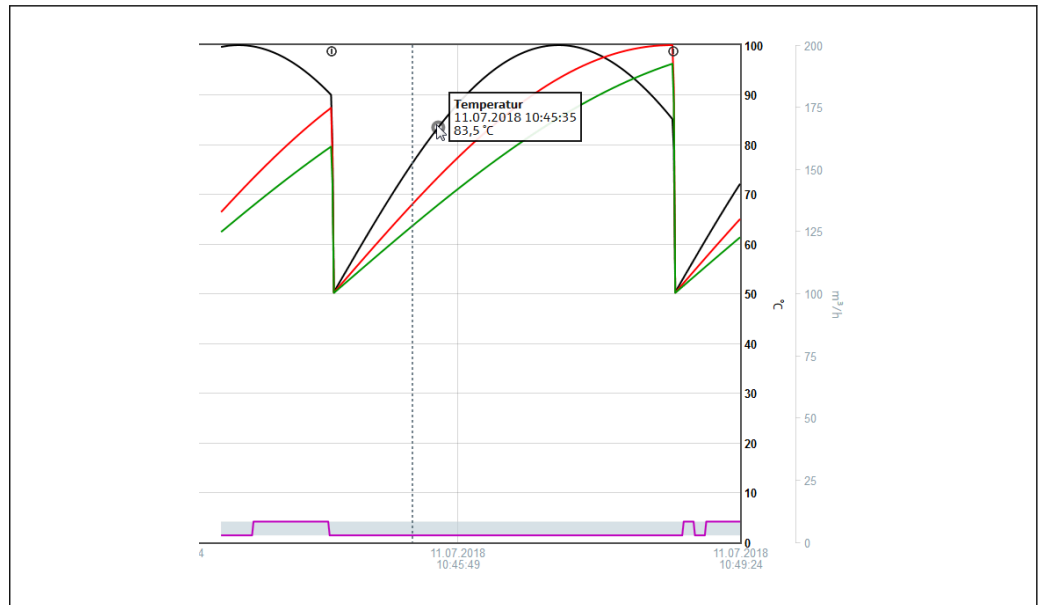

A0037116

#### 11.4.4 Remote control via the Web server

**i** This function is **not** supported by the **DIN rail version**.

The device can be remote-controlled via the Web server. In the Web server, the remote control function can be found under "**Measured values -> Remote control**". Here the display shown corresponds directly to the device display. The device is operated using buttons below this display. The interval for refreshing the display can be set in the "**Refresh**" menu.

**Enabling remote control on the device:**

1. In the menu **Setup -> Advanced setup -> Communication -> Ethernet -> Configuration Web server -> Remote control**, select "**Yes**" or under
2. **Expert -> Communication -> Ethernet -> Configuration Web server -> Remote control**, select "**Yes**".

### 11.5 Changing the group

The group to be displayed can be changed in the main menu under "**Operation -> Change group**". Alternatively, the group can also be changed by turning the navigator.

**Version with stainless steel front and touchscreen:**

The active groups can be changed with a horizontal "swiping" movement.

- i** For the DIN rail version: The active groups can only be queried and changed via the Web server under "**Measured values -> Instantaneous values / Instantaneous values as curves / History**". The groups are created as tabs and can be selected by mouse click.
- i** Only the **active** groups are displayed here. The settings for this can be made in the main menu under "**Setup -> Advanced setup -> Application -> Signal groups -> Group x**".

### 11.6 Locking operation



**i** This function is **not** supported by the **DIN rail version**.

Local operation can be blocked in the main menu under "**Operation -> Lock operation**" to prevent unintended or incorrect operation (e.g. when cleaning the device).

-  The device is unlocked by pressing the navigator or the OK operating key for 3 s. When using an external keyboard, the device is unlocked with the key combination "Ctrl-Alt-Del".



## 11.7 Login / logout

Log onto the device or log off the user currently logged on.

-  Only for active user administration (FDA 21 CFR Part 11) or role-based access protection →  54

## 11.8 Changing the password

Change the user password.

-  The access concept (free/access code/user roles/FDA) must first be defined: "**Menu -> Expert -> System -> Security -> Protected by -> FDA 21 CFR Part 11**" →  54

The password can also be changed via the Web server under "**Data management -> Change password**".

## 11.9 SD card/USB stick

### 11.9.1 Function of SD card or USB stick

Without affecting the internal memory, data packets are copied block by block (min. 1 x daily, midnight) to the SD card. Tests are also made to determine whether the data have been written without any errors. Once a new SD card is inserted, the device starts saving the data automatically after 5 minutes. The use of a USB stick is only recommended if certain data ranges should be copied.

For the panel version: The USB stick is **not** used for storing the measured values continuously, i.e. it is **not** automatically updated.

Data are saved in two different folders on the storage media depending on the storage method:

- All data are copied cyclically to the **rec\_data\_<Device name>** folder if a data packet is complete or the function **"Update"** is activated under **"Operation -> SD card/USB stick -> Update"**.
- The data for the selected time range that was selected under **"Operation -> SD card / USB stick -> Save measured value"** are copied to the **rng\_data\_<device name>** folder. Copying these data does not affect the storage of the data in the **rec\_data\_<device name>** folder.

-  Only use new, formatted SD cards that are recommended by the manufacturer (see "Accessories" → 97).
- During normal operation, the used memory space on the SD card or USB stick is displayed on the top right of the display ("SD: xx%" or "USB: xx%"). Dashes "-" on this display mean that no SD card is inserted.
- The SD card must not be write-protected.
- Prior to removing the external data carrier, select **"Operation -> SD card/USB stick -> Update"**. The current data block is closed and saved to the external data carrier. This ensures that all the current data (up until the last save) is included on the data carrier.
- Depending on the device configuration (see **"Setup -> Advanced setup -> System -> Ext. memory -> Warning at"**), an acknowledgeable message on the display notifies the user that the external data carrier has to be changed before the data carrier is 100 % full.
- The device keeps track of which data have already been copied onto the SD card or USB stick. If the data carrier is not changed in time or if no SD card is inserted, the new external data carrier is filled with the missing data from the internal memory - insofar as the data are still in the memory. As measured value acquisition/recording is assigned the highest priority, it may take several minutes in this case for the data to be copied from the internal memory to the SD card or USB stick.

### 11.9.2 DIN rail version: function of SD card or USB stick

**USB A socket "Host"** e.g. for USB memory stick or printer

If a USB stick is inserted, data that have not yet been saved are copied to the stick automatically. The red LED flashes while data are being copied to the stick.

 **Do not remove the USB stick when the red LED is flashing! Risk of data loss!**

If an error occurs (e.g. USB stick full or defective), the red LED is lit constantly. Remove the USB stick and replace it.

#### SD card

Cyclic storage is completed via the "Safe SD card removal" button, the LED (d) goes out. The SD card can now be removed.

 If the SD card is not removed within 5 minutes, the write cycles start again.

LED at SD slot. Yellow LED lit or flashing when the device writes to the SD card or reads it.

 **Do not remove the SD card if the LED is lit or flashing! Risk of data loss!**

### 11.9.3 Functions relating to the SD card or USB stick

 These functions are **not** supported by the **DIN rail version**.

For functions to save measured data and device settings on a removable medium, see the main menu under "**Operation -> SD card / USB stick**" (only if an SD card or USB stick is provided).

**Remove safely:**

All internal access is terminated to ensure safe removal of the storage medium from the device. A message is displayed when the storage media can be removed. If the SD card is not removed, the device automatically starts to save data to the storage medium again after 5 minutes.

 Only remove the data storage medium using this function; otherwise data may be lost!

**Update:**

Measurement data not yet saved on the storage medium are now saved. This may take a moment. Measured value acquisition is running in parallel and has top priority.

 Data from several devices can be saved onto one storage medium.

▪ **Save measured values:**

A user-definable time range can be saved on the data storage medium.

▪ **Load setup:**

Loads device settings (setup) from the storage medium onto the device.

▪ **Save setup:**

All device settings (setup) are saved onto the storage medium. They can be archived or used for other devices.

▪ **Save setup as RTF:**

Saves the setup on the storage medium in a readable format as an RTF file (rich text format).

The RTF file can be opened and formatted using suitable word processing software (e.g. MS Word), allowing printouts to be easily made.

▪ **Screenshot:**

Save the current measured value display as a bitmap on the SD card or USB stick.

▪ **Update firmware:**

Loads new firmware onto the device. Only visible if a firmware file is provided on the SD card or USB stick.

 Caution: The device will restart. Save the setup and measured values beforehand on the SD card or USB stick.

▪ **Process screens:**

Load, export or delete process screens.

Load: Loads a process screen from the external storage medium into device memory.

Export: Saves the process screen in the device onto the external storage medium to transfer it to another device.

Delete: Deletes the selected process screen from device memory.

Procedure for creating and processing process screens: →  73

▪ **Load user administration:**

Loads all settings and user accounts from the storage medium to the device. The file has the extension ".ids2".

 Caution: Any existing settings/accounts are overwritten!



- **Save user administration:**  
Saves all settings and user accounts to the storage medium. The file has the extension ".ids2".
- **User administration as RTF:**  
Saves the user administration on the storage medium in a readable format as an RTF file (rich text format).
- **Import SSL certificate:**  
Uploads an SSL certificate (X.509) to the device. Certificates are needed to establish an SSL connection in order to send e-mails in an encrypted manner for example. Certificates are available from your network administrator or provider. The following are supported: DER, CER and CRT (binary or Base64-encoded).  
Only visible if an SSL certificate is provided on the SD card or USB stick.

### Creating a process screen using the process picture generator

 This function is **not** supported by the **DIN rail version**.

 The DVD provided with the Field Data Manager (FDM) software includes a process picture generator.

Alternatively download at:

[www.readwin2000.com/tools\\_files/ProcessPictureGenerator.zip](http://www.readwin2000.com/tools_files/ProcessPictureGenerator.zip)

This program allows the user to generate a process screen quickly and easily.

Start the process picture generator and create the first project:

1. Copy the entire "ProcessPictureGenerator" directory from the DVD to a local directory on the PC
2. Alternatively, unzip the downloaded ZIP file in a local directory on the PC
3. Double-click on the "FieldDiagrammer.exe" application it contains
4. The process picture generator is started and a new project is created
5. Select all fields required for the project such as project name, device type, etc. as well as the background picture
6. Edit the process screen accordingly
7. Use the function "**File -> Save**" to save the current project
8. Using the "**File -> Export**" function, save the process screen ("PP\_GROUP\_<xx>.bmp") with the necessary INI file ("PP\_GROUP\_<xx>.ini") to a USB stick or an SD card. Note: The "xx" in the file name stands for the group (01 to 10).
9. Remove the USB stick or SD card from the PC

Further help can be called directly from the help menu of the process picture generator.

Load the process screen in the device:

1. Plug the USB stick or the SD card containing the generated process screen into the device
2. In the main menu under "**Operation -> SD card / USB stick -> Process screen -> Group**", select the group to which the process screen is to be assigned
3. In the main menu under "**Operation -> SD card / USB stick -> Process screen -> Load**", select the desired process screen and upload it to the device
4. In the main menu under "**Operation -> Change display mode**", change the display mode to "**Process screen**".

*Editing process screens on the device*



Process screens can be edited on the device.

The following functions are possible:

- Add channels to/remove channels from the process screen
- Change the position, font size, and alignment
- Delete the process screen

**Call up the Context menu:** In the measured value display, press the navigator or "Menu" for longer than 3s.

The "Process screen" submenu can be accessed in the context menu that now opens:

Parameter	Parameter/description
"Edit" submenu	Edit the process screen currently displayed (position, font size, etc.).
"Channel 1-8" submenu	Edit the selected channel of the process screen (enable, change position/font size etc.).
	<b>Display in the process screen</b> Switch the channel in the process screen on or off. Note: Does not affect measured value storage/configuration. Options: No, yes; factory setting: no
	<b>Channel ident.</b> Specify whether the channel identifier should be displayed in addition to the measured value. The channel identifier is displayed above the measured value. Options: No, yes; factory setting: no
	<b>Alignment</b> Specify how the measured value should be aligned.  For "Align left", the x-position is the left top-hand corner of the measured value. For "Align right", the x-position is the right top-hand corner of the measured value. Options: Align left, align right Factory setting: Align right
	<b>x-position</b> Selection of the x-position where the measured value is to be displayed. User entry: 0 to 799 pixels; factory setting: 10  The point of origin (x-/y-zero point) is the top left. When the x-value is increased the text moves to the right.
	<b>y-position</b> Selection of the y-position where the measured value is to be displayed.  The point of origin (x-/y-zero point) is the top left. When the y-value is increased the text moves down. User entry: 0 to 450 pixels; factory setting: 50 (channel 1) to 260 (channel 8)
	<b>Font size</b> Selection of the font size in which the measured value is to be displayed. Options: Small, medium, large, very large; factory setting: large
<b>Accept changes</b>	Saves the changes to the process screen in the device memory.
<b>Delete</b>	Deletes the selected process screen from the device memory. The device then changes to the curve display.

### 11.9.4 Notes on e-mail encryption

In addition to sending unencrypted e-mails, it is also possible to send encrypted e-mails via SSL (TLS). To do so, you can choose either of two ways:

- By **SMTPTS**: fully encrypted via port 465.  
The complete connection runs over TLS. The port is 465 by default but this value can be changed in the Setup.
- Via port 25 or 587 using **STARTTLS**.  
With this method the device first establishes a plain SMTP connection via port 25 and continues this connection following agreement and switchover to encryption.

The required process can be selected as follows: **"Setup -> Advanced setup -> Application -> E-mail -> Server requires SSL"** or under **"Expert -> Application -> E-mail -> Server requires SSL"**.

TLS V1.0 (=SSL 3.1), V1.1 and V1.2 are supported. Older standards are not supported. The encryption method is automatically agreed with the counterparty.

A certificate must be installed in order to be able to send encrypted e-mails. These certificates can be obtained from your e-mail service provider. The following file formats are supported:

- \*.CER: DER- or Base64-encoded certificate
- \*.CRT: DER- or Base64-encoded certificate
- \*.DER: DER-encoded certificate

 The file name of the certificate may only contain the following characters: a..z, A..Z, 0..9, +, -, \_, #, (, ), !

To establish an SSL connection, the device automatically selects the certificate that best suits the counterparty from all the installed certificates. An error message is displayed if the device does not have any of the required certificates.

 When e-mail encryption is enabled, no e-mails can be sent if a valid certificate is not available or if the certificate has expired.

### 11.9.5 Notes on WebDAV encryption

In addition to sending unencrypted data to the WebDAV server, it is also possible to send encrypted data via SSL (TLS). All data are sent in encrypted format via the SSL port of the external WebDAV server.

The complete connection runs over TLS. The port is 80 by default but this value can be changed in the Setup. The procedure to be used can be selected as follows: **"Setup -> Advanced setup -> Application -> WebDAV Client -> Enable -> Yes (SSL)"** or under **"Expert -> Application -> WebDAV Client -> Enable -> Yes (SSL)"**.

TLS V1.0 (=SSL 3.1), V1.1 and V1.2 are supported. Older standards are not supported. The encryption method is automatically agreed with the counterparty.

A certificate must be installed in order to be able to send encrypted data. These certificates can be obtained from your WebDAV server service provider. The following file formats are supported:

- \*.CER: DER- or Base64-encoded certificate
- \*.CRT: DER- or Base64-encoded certificate
- \*.DER: DER-encoded certificate

 The file name of the certificate may only contain the following characters: a..z, A..Z, 0..9, +, -, \_, #, (, ), !

To establish an SSL connection, the device automatically selects the certificate that best suits the counterparty from all the installed certificates. An error message is displayed if the device does not have any of the required certificates.

 When WebDAV client encryption is enabled, no data can be sent if a valid certificate is not available or if the certificate has expired.

### 11.9.6 SSL certificates

#### Importing an SSL certificate

Installing a certificate via SD card or USB stick:

1. Copy a certificate on a PC to an SD card or USB stick
2. Insert the SD card or USB stick into the device
3. In the main menu, select **"Operation -> SD card (or USB stick) -> Import SSL certificate"**
4. Select the required certificate from the list and follow the dialog on the display.

Installing a certificate via the Web server:

1. On the Web server, select **"Data management --> Import SSL certificate"**
2. Select the file
3. Start the process by clicking **OK**

 Up to 3 certificates can be installed simultaneously.

### Verifying the installed SSL certificates

The installed certificates can be verified in the main menu under **"Diagnostics -> Device information -> SSL certificates"**. The most important certificate information, e.g. subject key ID, organization and validity period, are displayed in the parameter list.

 Not all fields are completed on all the certificates. This is because the parties issuing the certificates do not make all the information available.

### Deleting an SSL certificate

In the main menu select the certificate to be deleted under **"Diagnostics -> Device information -> SSL certificate -> Certificate"** and select **"Yes"** under **"Delete certificate"**.

### Period of validity of certificates

Certificates are valid for a defined period (valid from ... to ...). The device checks the certificate validity once a day or each time the device is rebooted. 14 days before the certificate expires the device notifies the user daily (by e-mail, screen display, entry in event log) that the certificate will expire shortly.

If the certificate has expired the alarm relay switches (if activated) and a message is displayed on the screen. An entry is also made in the event log. If a certificate is deleted all errors related to this certificate are reset.



## 11.10 Show data logging

 For the **DIN rail version**, see →  67

You can scroll through the saved measured values in the main menu under **"Operation -> History"**. Turn the navigator clockwise or counterclockwise to scroll back and forth between the measured value curves. Press the navigator to make other settings for the historical data display (e.g. scroll speed, time scaling or change display mode) or to quit the historical data function.

### Version with stainless steel front and touchscreen:

The measured value curves can be scrolled back and forth with a horizontal "swiping" movement.

 The gray header on the screen and the  symbol in the status bar indicate that historical values are being displayed. In the instantaneous value display the color of the header is blue.

### 11.10.1 Historical data: changing a group

It is possible to change the group to be displayed in the historical data under **"Operation -> Change group"** in the data history.

### 11.10.2 Historical data: Scroll speed

It is possible to change the scroll speed in the historical data under "**Operation -> Scroll speed**" in the data history.

The scroll speed can also be set via the soft key with the arrow symbol < or >. The speed can be changed from < (slow) to <<<< (fast) by pressing the soft key repeatedly.

### 11.10.3 Historical data: Time scaling

It is possible to scale the displayed time range in the historical data under "**Operation -> Time scaling**" in the data history.



Notes:

- "1:1" option: Every measured value is displayed.
- "1:n" option: Only every nth measured value is displayed (increases the displayed time range).
- No interpolation is performed, nor is the mean value determined.
- If the value for "n" is large, this can result in extended loading times.
- Time scaling does not affect the process for storing the measured value.
- The time range displayed per screen for the currently set time scaling is also displayed in the menu.

### 11.10.4 Historical data: Time range displayed

The displayed time range is shown in the historical data under "**Operation -> Time range displayed**" in the data history. This tells the user which time range is displayed per screen in the standard memory cycle.



If the alarm cycle differs from the standard memory cycle, this is not taken into consideration.

### 11.10.5 Historical data: Screenshot

The current measured value display can be saved as a bitmap to an SD card or USB stick in the historical data under "**Operation -> Screenshot**".

### 11.10.6 Historical data: Change the display mode



For the **DIN rail version**, see → 67

It is possible to change the display mode of the active group in the historical data under "**Operation -> Change display mode**" in the data history.

The following display modes are possible: Curve, Curve in ranges, Waterfall, Waterfall in ranges, and Circular chart.



The various display modes have no influence on the signal recording.

### 11.10.7 Historical data: Store text

A predefined text can be selected or a user-defined text can be saved in the historical data under "**Operation -> Store text**". This text is assigned to a definable point in time.



## 11.11 Signal analysis

The analyses saved in the device are displayed in the main menu under "**Operation -> Signal analysis**".

- **Actual intermediate analysis:**  
The current (i.e. not yet completed) intermediate analysis can be displayed here.
- **External analysis 1-4:**  
Current (i.e. not yet completed) external analyses can be displayed here.
- **Actual day:**  
The current (i.e. not yet completed) daily analysis can be displayed here.
- **Actual week:**  
The current (i.e. not yet completed) weekly analysis can be displayed here.
- **Actual month:**  
The current (i.e. not yet completed) monthly analysis can be displayed here.
- **Actual year:**  
The current (i.e. not yet completed) annual analysis can be displayed here.
- **Search:**  
Search and display of analyses. Select which analyses the system should search for/  
display: Intermediate analysis, Daily analysis, Monthly analysis, Annual analysis.

## 11.12 Search in trace

In the main menu, the internal memory can be searched for events or times under "**Operation -> Search in trace**".

 For the **DIN rail version**, see →  67

**Search for events:** The event logbook forms the basis for searches for events. To search more easily for certain events (e.g. setup changes), the search filter can be used to select and search for the desired events. In the standard all events are shown. In the event list displayed, it is possible to select an event and go directly to this point in the history (if still in the memory).

**Search for time:** When searching for a time in the past, the user can enter a date and a time to specify when the system should start displaying historical data. Once the date/time have been entered and confirmed, the display goes to the selected time in the active group.

## 11.13 Changing the display mode

The display mode of the active group can be changed in the main menu under "**Operation -> Change display mode**".

The following display modes are possible: Curve, Curve in ranges, Waterfall, Waterfall in ranges, Bargraph, Digital display, Instrument display, Circular chart and Process screen.

 The various display modes have no influence on the signal recording.

## 11.14 Store text

A predefined text can be selected, or a user-defined text can be saved, in the main menu under "**Operation -> Store text**". This text is assigned to a definable point in time.

## 11.15 Printout

 This function is **not** supported by the **DIN rail version**.

The device settings, user administration data, event log, current measured values or a screenshot of the measured value display can be printed out in the main menu under "**Operation -> Printout**".

**NOTICE**

Due to technical restrictions, the printout from the device is always in English when using the following operating languages: Polish, Russian, Swedish, Czech, Japanese, and Chinese.

Printout via PC:

- ▶ The device settings or user administration can be saved in the set language in the form of an RTF file and printed out from the PC.

**NOTICE**

Due to technical restrictions, the event log cannot be printed out from the device when using the following operating languages: Polish, Russian, Swedish, Czech, Japanese, and Chinese.

Printout via PC:

- ▶ The event log can be printed out via the Field Data Manager (FDM) software. Alternatively the event log can be saved as a CSV file and printed out from the PC.

## 11.16 Adjusting the brightness of the display

 This function is **not** supported by the **DIN rail version**.

You can adjust the brightness of the display in the main menu under "**Operation -> Adjust brightness**":

Parameter	Possible settings	Description
Adjust brightness	0-100 Default: <b>80</b>	Sets the brightness of the display

## 11.17 Limit values

 This function is **not** supported by the **DIN rail version**.

It is possible to change the limit values during operation in the main menu under "**Operation -> Limits**".

 This function must be enabled beforehand in the main menu under "**Expert -> Application -> Limits -> Change limits: outside of setup also**".

Detailed description of the limit values: →  245

## 11.18 WebDAV client

The function of the WebDAV client is to transmit recorded data automatically to a connected WebDAV server (e.g. NAS drive). The recorded data are sent to the connected WebDAV server cyclically every 15 minutes. The generated files correspond to the files that are automatically saved to the SD card.

The client is configured via "**Setup -> Advanced setup -> Application -> WebDAV Client**". The settings under "**Setup -> Advanced setup -> System -> External memory**" are also used, with the exception of the settings for the SD card (Memory build-up, Warning and Relays). The memory is regarded as a stack memory.

Detailed description of the parameters: →  269

 Note: With the WebDAV client, the data are transmitted to the WebDAV server in accordance with the selection made in the .CSV or "Protected format".

### 11.18.1 Access to the WebDAV server via HTTP (HTML)

Address entry in browser: **http://<ip-address>/webdav**

The data are updated cyclically every 15 minutes. The data are automatically updated each time a user logs in.

 Note: Leading zeros in IP addresses must not be entered (e.g. enter 192.168.1.11 instead of 192.168.001.011).

 Administrator or service authentication is required. ID and password administration is performed in the main menu under **"Setup -> Advanced setup -> Communication -> Ethernet -> Configuration Web server -> Authentication"**.

ID default value: admin; Password: admin

Note: The password should be changed during commissioning!

If security is activated in accordance with "FDA 21 CFR Part 11", authentication as a user with administrator rights is required in order to establish a connection.

Note: For devices with a stainless steel front and touchscreen, the data are always made available in "Protected format" via the WebDAV server.

## 11.19 Data analysis and visualization with the Field Data Manager software (FDM) provided

The analysis software offers centralized data management with visualization for recorded data.

This enables the data of a measuring point to be fully archived, e.g.:

- Measured values
- Diagnostic events
- Protocols

The analysis software stores data in an SQL database. The database can be operated locally or in a network (client/server). The free PostgreSQL database supplied on the DVD can be installed and used.

 For details, see the Operating Instructions on the analysis software DVD provided.

### 11.19.1 Structure/layout of a CSV file

The CSV files are comprised as follows:

File name (=serial number + file number + configuration number + date and start time + data type)	Description	Coding
H4000504428 0000000279 0000000185 2013-11-07 11-18-00 GROUP01.csv	Contains all the measured values of the group from the starting time indicated in the file name. An individual CSV file is created for each group.	ANSI
H4000504428 0000000279 0000000185 2013-11-07 11-30-00 ANALYSIS01.csv	Contains the signal analyses of the active channels from the starting time indicated in the file name. An individual CSV file is created for every analysis (01 - 04).	ANSI
H4000504428 0000000279 2013-11-07 11-18-34 EVENTS.csv	Contains the event log from the starting time indicated in the file name.	Unicode UTF-8 (see the notes in the following section)

*Meaning of the values under "Status" and "Limit" when analyzing a group:*

Status of the channel:
0: OK
1: Cable open circuit



**Status of the channel:**

- 2: Input signal too high
- 3: Input signal too low
- 4: Invalid measured value
- 6: Error value, i.e. not the calculated value (for mathematics if an input variable is invalid)
- 7: Sensor/input error
- Bit 8: Not assigned
- Bit 9: Alarm storage
- Bit 10..13: Not assigned
- Bit 14: Use error value
- Bit 15: Not assigned

**General status:**

- 1: High speed storage is active
- 2: Additional hour for summer/normal time changeover

Note: A combination of 1 and 2 is also possible.

**Status of the limit value ("Limit"):**

- 0: OK, no limit value has been violated
- Bit 0: Lower limit value
- Bit 1: Upper limit value
- Bit 2: Increasing gradient
- Bit 4: Decreasing gradient

Note: A combination is also possible.

### 11.19.2 Importing UTF-8-encoded CSV files into spreadsheets

You might encounter problems displaying information if importing UTF-8-encoded CSV files directly into more recent versions of MS Excel™ (2007 and higher).

#### Importing CSV data from the event logbook ("Events") into MS Excel™ (version 2007 and higher):

1. In the menu select **"Data -> Get external data - From text"**
2. MS Office 365 and higher: In the menu select **"Data -> From text/CSV"**
3. Select the CSV file
4. Follow the instructions in the wizard
5. Select file origin **"Unicode UTF-8"**

## 12 Diagnostics and troubleshooting

The following section contains an overview of possible causes of errors to provide initial assistance during troubleshooting.

### 12.1 General troubleshooting

#### **WARNING**

**Danger! Electric voltage!**

- ▶ Do not operate the device in an open condition for error diagnosis!

Display	Cause	Remedial action
No measured value display; no LED lit	No supply voltage connected	Check the device supply voltage.
	Supply voltage is applied; device or power unit is defective	Replace the power unit or device.
Diagnostic message is displayed	For a list of diagnostic messages, see the next section.	

 **Dead pixels:** Dead pixels refer to pixels on LCD and TFT displays that are defect due to the technology or manufacturing techniques used. The TFT display used can have up to 10 dead pixels (Class III as per ISO 13406-2). These dead pixels do not entitle the user to a warranty claim.

### 12.2 Troubleshooting

The Diagnostics menu is used for the analysis of the device functions and offers comprehensive assistance during troubleshooting. Always proceed as follows to locate the cause of device errors or alarms.

#### General troubleshooting procedure

1. Open diagnosis list: lists the 30 most recent diagnostic messages. This can be used to determine which errors are currently present and whether an error has repeatedly occurred.
2. Diagnosis of current measured values: Verify the input signals by displaying the current or scaled measuring ranges. To verify calculations, call up calculated auxiliary variables if necessary.
3. Most errors can be rectified by performing steps 1 and 2. If the error persists follow the troubleshooting instructions in the following sections.
4. If this does not rectify the problem, contact the Service Department. Any time you contact the Service Department please always have the error number and the information in the main menu under "**Diagnostics -> Device information**" (program name, serial number etc.) to hand.

The contact data for your Endress+Hauser representative can be found on the Internet at [www.endress.com/worldwide](http://www.endress.com/worldwide).

#### 12.2.1 Device error/alarm relay

One relay can be used as an alarm relay. If the device detects a system error (e.g. hardware defect) or a malfunction (e.g. cable open circuit), the selected output/relay switches. The alarm relay is assigned in the main menu under "**Setup -> Advanced setup -> System -> Fault switching -> Relay x**". **Factory setting: Relay 1.**

This "alarm relay" switches if "F"-type or "S"-type errors occur, i.e. "M"-type or "C"-type errors do not switch the alarm relay.

## 12.3 Diagnostic information on the local display

The diagnostic message consists of a diagnostic code and a message text.

The diagnostic code is made up of the error category as per Namur NE 107 and the message number.

Error category (letter in front of the message number)

- **F = Failure.** A malfunction has been detected.

The measured value of the affected channel is no longer reliable. The cause of the malfunction is to be found in the measuring point. If a controller is connected, it should be switched to manual mode. An alarm relay can be assigned to this error category in the Advanced setup.

- **M = Maintenance required.** Action must be taken as soon as possible.

The device still measures correctly. Immediate measures are not necessary. Proper maintenance efforts may prevent a possible malfunction in the future.

- **S = Out of specification.** The measuring point is being operated outside specifications. Operation is still possible. There is the risk of increased wear, a shorter operating life or less accurate measurements. The cause of the problem is to be found outside the measuring point.

- **C = Function check.** The device is in Service mode.

Diagnostic code	Message text	Description	Remedy
F100	Sensor/input error!	Sensor/input error!	Check connections and parameters
F101	Open circuit	Open circuit	Check connections
F105	Invalid value!	Measured value is invalid (when calculating --> NAN)	Check connections and process variables
F201	Device fault	Device error	Contact the Service Department
F261	Error: RAM	No access to RAM	Contact the Service Department
F261	Error: Flash	No access to flash	Contact the Service Department
F261	Error: SRAM	No access to SRAM	Contact the Service Department
F261	Analog card x is out of order!	Hardware defect detected	Contact the Service Department, replace card
F261	HART card out of order!	Hardware defect detected	Contact the Service Department, replace card
F261	Power supply out of order!	Hardware defect detected	Contact the Service Department, replace power unit
F261	Digital card out of order!	Hardware defect detected	Contact the Service Department, replace card
F261	Fieldbus card out of order!	Hardware defect detected	Check contacts of Anybus card, contact the Service Department
M262	Fieldbus module is obsolete. Please replace the hardware!	The installed fieldbus module is not approved for this firmware version.	Replace the hardware or downgrade the firmware (not recommended).
M284	Firmware update	Firmware has been updated	No action required. Message can be acknowledged.
M290	Internal flash reaches the end of its lifetime. Please replace device.	The internal flash memory is defective.	Replace device
F301	Error: Cannot load setup	Setup defective	Switch the device off and then on again, re-configure, contact the Service Department if necessary
M302	Setup restored from backup	Setup has been loaded from backup	Check setup
F303	Error: Device data	Device data defective	Contact the Service Department
M304	Backup: Device data	Device data defective. However it was possible to continue working with the backup data.	Check settings (e.g. serial number)
F307	Error: Customer preset value defective	Customer preset value defective	

Diagnostic code	Message text	Description	Remedy
F309	Error: Date/time is not set	Invalid date/time (e.g. internal battery is empty)	Device was switched off too long. The date/time must be set again. Battery might need to be replaced (contact the Service Department).
F310	Error: Cannot save setup	The setup could not be saved	Contact the Service Department
F311	Error: Device data	The device data could not be saved	Contact the Service Department
F312	Error: Calibration data defective	The calibration data could not be saved	Contact the Service Department
F312	Analog card x is not calibrated!	Analog card x is not calibrated! The device works with default values, i.e. the measured values may be inaccurate under certain circumstances.	Contact the Service Department
M313	SRAM has been defragmented	SRAM was defragmented after firmware update	No action required. Message can be acknowledged.
F314	Error: Option code	Activation code is no longer correct (incorrect serial number/program name). Option was disabled and setup preset has been performed.	Enter new code
M315	No IP address could be obtained from the DHCP server!	No IP address could be obtained from the DHCP server!	Check the network cable
M316	Invalid MAC address!	No or incorrect MAC address	Contact the Service Department
M317	Battery voltage < 2.5 V. Please replace battery!		Battery needs to be replaced (contact the Service Department)
F348	Firmware cannot be updated: <ul style="list-style-type: none"> <li>■ Checksum incorrect</li> <li>■ Firmware incompatible!</li> </ul>	Firmware update has been aborted because the firmware file is damaged or is not compatible with this device	Contact the Service Department
M350	Measured value acquisition interrupted for calibration/service work. Measured value acquisition restarted.	Measured value acquisition was interrupted/reactivated for service/maintenance purposes. Causes include: <ul style="list-style-type: none"> <li>■ Calibration of inputs/outputs</li> <li>■ Firmware update</li> </ul>	No action required. Message can be acknowledged.
M351	The device is restarted.	The device is rebooting. Causes include: <ul style="list-style-type: none"> <li>■ Following a firmware update</li> <li>■ Change to device options</li> </ul>	No action required. Message can be acknowledged.
F431	Error:Calibration	Calibration data missing	Contact the Service Department
M502	Device is locked!	Device is locked! The message appears when an attempt is made to update the firmware, for example	Check lock per digital channel
F510	Setup was corrected.	The device has discovered that the configuration is no longer correct. All the parameters concerned have been reset to the factory default settings. Possible causes: <ul style="list-style-type: none"> <li>■ Input cards have been removed or replaced by another type</li> <li>■ An input card is no longer working correctly</li> </ul> A firmware update has caused compatibility problems. Note: This error message appears each time the device is restarted until at least one change has been made to the configuration.	Check the configuration of the device. If hardware has been replaced, no other action is needed (recommendation: change the operating language so that the error message no longer appears after the next restart).
F510	User administration was corrected	The device detected that the user administration settings were no longer correct. All the parameters concerned have been reset to the factory default settings.	

Diagnostic code	Message text	Description	Remedy
M520	SMTP: Name could not be resolved (DNS)! SNTP: Name could not be resolved (DNS)!	Problem with name resolution (DNS). SMTP: e-mail SNTP: time synchronization	Check the corresponding settings
F526	<ul style="list-style-type: none"> <li>▪ Support points not OK!</li> <li>▪ Support points: x-value exists more than once</li> <li>▪ Upper and lower support points are identical</li> </ul>	Support points entered for the linearization table are not plausible.	Check support points
M528	Setup is not compatible with this firmware	An attempt was made to load a setup which is not compatible with this firmware (e.g. another device type)	Check whether the correct file has been selected.
M530	Cannot copy setup.	An error occurred when a setup was loaded from an SD card or USB stick An error occurred when a setup was saved to an SD card or USB stick	Replace the SD card or USB stick Setup file defective?
F537	EtherNet/IP: IP address conflict identified	The IP address configured for EtherNet/IP is already being used by another device	Check the IP configuration and change it as necessary
F537	EtherNet/IP: IP configuration not accepted at all or in part	At least one setting for the IP address, subnet mask and/or gateway is incorrect and has not been accepted.	Check the IP configuration and change it as necessary
S901	Input signal too small	Input signal too small	Check connections and parameters. Check connected sensor/transmitter.
S902	Input signal too high	Input signal too high	Check connections and parameters. Check connected sensor/transmitter.
M905	Limit x	Limit x has been violated	Note: Error number only occurs if e-mails are sent
M906	End limit x	Limit x no longer violated	Note: Error number only occurs if e-mails are sent
F907	Error DP flow	Error during DP flow calculation	
F910	This software is not enabled for this device.	The current firmware is not enabled for this hardware	Contact the Service Department
M913	DP Flow: outside ISO 5167!	Error during DP flow calculation	
M914	DP Flow: density calculation!	Error during DP flow calculation	
M920	Too many messages that need to be acknowledged!	There are too many messages that need to be acknowledged. Another message could not be added.	Acknowledge messages
M921	SD card x% full.	External memory is full	Replace SD card
M922	No cyclic value readout	The instantaneous values were not read out for a set time	
M922	No cyclic transfer	The device was not read out via fieldbus for a configurable time	Check the communication of the fieldbus. Check PLC.
M923	Error printing!	Various problems while printing, e.g.: <ul style="list-style-type: none"> <li>▪ Printer spooler is full</li> <li>▪ Printer needs paper!</li> <li>▪ Printer is not ready!</li> <li>▪ Replace toner/ink!</li> </ul>	Check printer status at the printer.
M924	Error accessing SD card! Error accessing USB stick! SD card is not or wrong formatted! USB stick is not or wrong formatted!	Impossible to access the removable data medium. Causes include: Memory is larger than 32 GB Invalid format (only FAT or FAT32 are permitted)	Check/replace removable data medium
M925	SD card is write-protected!	SD card is write-protected!	Remove write protection

Diagnostic code	Message text	Description	Remedy
M927	Insufficient space free on data storage medium!	An attempt was made to save to the SD card or USB stick (setup, screenshot, etc.), but not enough free memory space is available.	Use other SD card/USB stick. Delete files that are no longer needed from the SD card/USB stick
M927	Insufficient space free on data storage medium!	An attempt was made to save to the WebDAV server but not enough free memory space is available.	Use other WebDAV server. Delete files that are no longer needed from the WebDAV server.
F929	File is damaged!	The file that should be loaded is damaged/invalid (e.g. wrong checksum).  This message can occur in connection with the following actions, for instance: <ul style="list-style-type: none"> <li>▪ Loading setup from SD card/USB stick</li> <li>▪ Firmware update</li> <li>▪ Load process screens</li> </ul>	Create file again, use other storage medium.
M940	E-mail could not be sent! (x)	E-mail could not be sent!  Optional: Error code (x) from server: e.g.: <ul style="list-style-type: none"> <li>▪ 451: Requested action aborted: local processing error</li> <li>▪ 554: Transaction failed. Possible reason: e-mail was not sent as suspected of being SPAM</li> <li>▪ 1: No free buffer</li> <li>▪ 2: No receiver specified</li> </ul>	Check settings/network connection <ul style="list-style-type: none"> <li>▪ 451: Try again</li> <li>▪ 554: Use other e-mail provider</li> </ul>
M941	No connection to the e-mail server!	A connection to the e-mail server could not be established because: <ul style="list-style-type: none"> <li>▪ The entered connection data are incorrect</li> <li>▪ The connection is lost</li> </ul>	Check settings/network connection
M942	SMTP: Fault occurred (x).	An error occurred when sending an e-mail. x= error code: 0: SMTP was switched off when the mail was being sent 3: TCP/IP connection was denied 4: TCP/IP connection error 5: SMTP server denied 6: Error during authentication 7: Connection unexpectedly lost 8: Server responded with error code 9: Timeout 10: Internal protocol error	Check settings/network connection
M944	SMTP: authentication failed!		Check settings/network connection
M945	SNTP: Time was not synchronized!	Time could not be synchronized via SNTP.  Possible reasons: <ul style="list-style-type: none"> <li>▪ SNTP server temporarily unavailable</li> <li>▪ Settings not correct</li> </ul>	<ul style="list-style-type: none"> <li>▪ Check settings</li> <li>▪ Check whether the error occurs often. If it does, choose another time server.</li> </ul>
M945	SNTP server 1 not responding. Try server 2.	Time could not be synchronized via SNTP.  Possible reasons: <ul style="list-style-type: none"> <li>▪ SNTP server temporarily unavailable</li> <li>▪ Settings not correct</li> </ul>	<ul style="list-style-type: none"> <li>▪ Check settings</li> <li>▪ Check whether the error occurs often. If it does, choose another time server.</li> </ul>
M946	Screenshot could not be saved (x)!	Screenshot could not be created.  Possible causes (x): 0: Error when writing 1: Insufficient free space 2: Bitmap could not be created 3: SD card/USB stick not available or not yet ready	Check/replace the SD card or USB stick
M947	Modem could not be initialized! Check the cable and modem.	The connected modem could not be initialized by the device.	Check the cable and modem.

Diagnostic code	Message text	Description	Remedy
M950	Cannot load SSL certificate.	Cannot load SSL certificate. Cause: <ul style="list-style-type: none"> <li>■ Invalid file format</li> <li>■ File is damaged</li> </ul>	<ul style="list-style-type: none"> <li>■ Use a certificate with a valid file format</li> <li>■ Import certificate to device again</li> </ul>
F951	SSL certificate '...' has expired!	Certificates have an expiry date, i.e. they must be renewed from time to time.	Install a new certificate
M952	SSL certificate '...' expires on ...!	The device warns the user shortly before the certificate expires.	Install a new certificate
M953	x certificates have already been installed. Delete certificates that are no longer required.	The device can manage a maximum of 3 X.509 certificates.	Delete a certificate that is already installed and no longer required
M954	SSL certificate not found: key ID = ...	Unable to establish an SSL connection as a suitable certificate is not installed.	Install a suitable certificate
M955	SSL connection denied!		
M956	Incorrect password. Your user account has been locked!	Incorrect password. User account has been locked!	Contact the administrator to unfreeze the account.
M956	Incorrect password. Your user account has been locked for 10 minutes!	An incorrect password was entered and the account is locked temporarily.	Wait until the temporary block has been disabled or contact your administrator.
M957	Wet steam alarm	Warning for wet steam alarm	Check the application (pressure, temperature inputs)
M965	SMS could not be sent!	SMS could not be sent because: <ul style="list-style-type: none"> <li>■ The entered connection data are incorrect</li> <li>■ There is no connection to the service provider</li> </ul>	Check connections and communication settings
M971	No channels assigned to batch x!	The batch functionality was switched on but no channels were assigned to the batch.	Check group settings
M980	No connection to the WebDAV server	A connection to the WebDAV server could not be established because the entered connection data are incorrect or the connection has been interrupted.	Check settings/network connection
M981	WebDAV: authentication failed!		Check settings
M982	WebDAV: directory or file could not be created!	Configured directory path not available.	Create a directory manually in the WebDAV server
M983	WebDAV: Fault	An unassigned error has occurred. The error is displayed in English.	
M984	No Ethernet connection.	The device is not connected by an Ethernet cable.	Establish cable connection.
M985	The test cannot be carried out because data are currently being copied by WebDAV.		Repeat later
M988	Server certificate cannot be loaded. Invalid format.	The file must be Base64-encoded. Format: X.509 certificate V3 incl. extension	Create the certificate again according to the specifications
M989	Private key cannot be loaded. Invalid size/format.	The file must be Base64-encoded. Only RSA keys with max. 2048 bits are supported.	Create the certificate again according to the specifications
M990	Server certificate cannot be installed.	General error. Unable to read or write to file.	Check the files on the USB stick and create again if necessary. If the error persists, contact the Service Department.

*HART® error messages*

Diagnostic code	Message text	Description	Remedy
M490	Channel x: Max. 5 devices may be connected per channel in Multidrop mode.	Max. 5 HART® devices may be connected to the input	Use other channels
M960	Value uncertain/ communication faulty	In the case of fieldbus systems: The status of the value is uncertain In the case of HART®: The current value is used instead of the digital value	
M970	Multi-master collision		<ul style="list-style-type: none"> <li>▪ Check additional master in HART® network (e.g. handheld)</li> <li>▪ Check master settings (secondary/primary)</li> </ul>
M986	Unable to read out self-calibration: channel=x, device address=y	The device was unable to read out the necessary data for determining the self-calibration.	Check the settings, check communication with the HART device
M987	The device does not support self-calibration: channel=x, device address=y	The connected device was replaced during operation. This device does not support self-calibration, however.	

## 12.4 Pending, current diagnostic messages

The diagnostic message that is currently active, the last diagnostic message and the last device restart are displayed in the main menu under "**Diagnostics -> Actual diagnostics**", "**Diagnostics -> Last diagnostics**" or under "**Diagnostics -> Last restart**".

## 12.5 Diagnosis list

The last 30 diagnostic messages are displayed in the main menu under "**Diagnostics -> Diagnosis list**" (messages with Fxxx, Sxxx or Mxxx-type error numbers).

The diagnosis list is designed as a ring memory, i.e. when the memory is full the oldest messages are automatically overwritten (no message).

The following information is saved:

- Error number
- Error text
- Date/time

## 12.6 Event logbook

Events such as alarm set point infringement and power failure are displayed in the correct time sequence. It can be found in the main menu under "**Diagnostics -> Event logbook**". Individual events can be selected and details displayed.

## 12.7 Device information

Important device information, e.g. serial number, firmware version, device name, device options, memory information, SSL certificates etc. are displayed in the main menu under "**Diagnostics -> Device information**".

 For further information open the online help on the device.



## 12.8 Diagnostics of measured values

Displays the current measured values in the main menu under "**Diagnostics -> Measured values**". The input signals can be verified here by displaying the scaled and calculated values. To verify calculations, call up calculated auxiliary variables if necessary.

## 12.9 Diagnostics of outputs

Displays the current states of the outputs (analog outputs, relays) in the main menu under "**Diagnostics -> Outputs**".

## 12.10 Simulation

Various functions/signals can be simulated for test purposes here.

### NOTICE

**Invoke simulation: for the simulation of the relays, see the main menu under "Diagnostics -> Simulation". For the simulation of the measured values, see the main menu under "Expert -> Diagnostics -> Simulation".**

Only the simulated values are recorded during simulation. The simulation is recorded in the event logbook.

- ▶ Do not start simulation if measured value recording must not be interrupted!

### 12.10.1 Test barcode reader

 This function is **not** supported by the **DIN rail version**.

The function (e.g. character set) of the barcode reader can be tested in the main menu under "**Diagnostics -> Simulation -> Test barcode reader**".

 Only visible if a barcode reader is connected.

### 12.10.2 E-mail test

A test mail can be sent to the selected recipient in the main menu under "**Diagnostics -> Simulation -> E-mail**".

 At least one e-mail address must be set beforehand.

### 12.10.3 Test WebDAV client

A test file can be sent to the selected WebDAV server in the main menu under "**Diagnostics -> Simulation -> WebDAV Client**".

 The settings for the WebDAV server to be addressed must be set beforehand under "**Setup -> Advanced setup -> Application -> WebDAV Client**".

### 12.10.4 Test telealarm

The telealarm functionality can be tested in the main menu under "**Diagnostics -> Simulation -> Test telealarm**". During this test, alarms are simulated and triggered.

 Only possible for the "Telealarm" device option.

For detailed descriptions of this device option, see the associated documentation.

### 12.10.5 Test time synchronization/SNTP

Time synchronization (SNTP setting) can be tested in the main menu under "**Diagnostics -> Simulation -> SNTP**".

 SNTP must be enabled beforehand in the main menu under "**Setup -> Advanced setup -> System -> Date/time set-up -> SNTP**".

Note: The test can take some time.

### 12.10.6 Test universal output

The active analog and pulse outputs can be tested in the main menu under "**Diagnostics -> Simulation -> Universal output**".

### 12.10.7 Relay test

The relay selected under "**Diagnostics -> Simulation -> Relay x**" can be switched manually in the main menu.

## 12.11 HART® diagnostics

Displays the device information and status of the connected HART® devices/sensors in the main menu under "**Diagnostics -> HART**".

 Note: It can take several seconds until all the information regarding the device/sensor is available!

Caution: Measured value acquisition slows down as additional information has to be read out.

 For further information open the online help on the device.

## 12.12 PROFINET diagnostics (option)

Display PROFINET diagnostics information in the main menu under "**Diagnostics -> PROFINET**".

## 12.13 Diagnostics EtherNet/IP (option)

Display EtherNet/IP diagnostics information in the main menu under "**Diagnostics -> EtherNet/IP**".

## 12.14 Initializing the modem

Initializes the modem connected (to automatically answer calls). The modem must support the complete AT command syntax.



- Set the baud rate in the main menu under "**Setup -> Advanced setup -> Communication -> Serial interface**" and select "**RS232**" as the interface type.
- Connect the modem to the RS232 interface of the device. For this purpose only use the modem cable, which is available as an accessory.

 A GSM modem can only be initialized if a SIM card is inserted and the PIN is entered or the prompt to enter the PIN has been disabled.

### 12.15 GSM terminal

Information on the reception quality.



Only possible for the "Telealarm" device option.

For detailed descriptions of this device option, see the associated documentation.

### 12.16 Status telealarm

Information on the status of individual alarms.



Only possible for the "Telealarm" device option.

For detailed descriptions of this device option, see the associated documentation.

### 12.17 Resetting the measuring device

The device can be reset to the as-delivered state with a PRESET. This function should only be performed by a service technician.

The function can be found in the main menu under **"Expert -> System -> PRESET"**



PRESET is only visible under "Expert" once the service code has been entered.

#### Procedure for resetting the measuring device

The PRESET returns all parameters to the factory default setup! The internal memory content is deleted!

- ▶ Save the setup and measured values on the USB stick or SD card. Then perform a PRESET.
  - ↳ The device is reset to the factory default settings.

### 12.18 Clear memory



The internal memory should be cleared after commissioning so that the analysis software does not contain any unnecessary data.

### 12.19 Reset analysis



The analyses should be reset after commissioning so that the analysis software does not contain any unnecessary data.

### 12.20 Firmware history

Overview of unit software history:

Unit software Version / date	Software changes	FDM analysis software version	Version of OPC server	Operating Instructions
V02.00.00 / 08.2015	Original software	V01.03.00.00 and higher	V5.00.03.00 and higher	BA01338R/09/01.15
V2.01.00 / 04.2016	Extended functionality/bug fixes	V01.03.01.00 and higher	V5.00.03.00 and higher	BA01338R/09/02.16
V2.01.05 / 11.2016	Extended functionality/bug fixes	V01.03.01.01 and higher	V5.00.03.00 and higher	BA01338R/09/03.16

Unit software Version / date	Software changes	FDM analysis software version	Version of OPC server	Operating Instructions
V2.02.00 / 11.2017	Ethernet function via USB	V1.04.00 and higher	V5.00.04.00 and higher	BA01338R/09/04.17
V2.04.00 / 09.2018	DIN rail version, Web server extension, Trustsens support	V1.04.02 and higher	V5.00.04.01 and higher	BA01338R/09/05.18
V2.04.05 / 08.2021	Support for HTTPS server; bugfixes	V1.04.02 and higher	V5.00.04.01 and higher	BA01338R/09/06.21

## 13 Maintenance

No special maintenance work is required for the device.

### 13.1 Updating the device software ("firmware")

Updating the device software ("firmware") via USB stick, SD card or Web server.

 The function to update the firmware via the Web server must be enabled beforehand under **"Expert -> Communication -> Ethernet -> Configuration Web server"**.

**There are two ways to update the firmware:**

- In the main menu under **"Operation -> SD card or USB stick -> Update firmware"**
- In the Web server under **"Data management -> Update firmware"**

 It is advisable to save the setup and measured values beforehand on the SD card or USB stick.

The device software ("firmware") should only be updated by a service technician.

The device will restart following the firmware update.

If an older firmware version (< V2.04.00) is installed on the device, the internal memory must then be cleared under **"Expert -> System"**.

 Only special, approved firmware versions may be installed for the "EtherNet/IP" and "PROFINET" options. For detailed descriptions of these device options, see the associated documentation.

### 13.2 Instructions for enabling a software option

Various device options can be enabled via an activation code. Available device options can be ordered as an accessory →  97. Once you place your order, you will receive instructions on how to activate the option and a code which must be entered under **"Main menu -> Expert -> System -> Device options -> Activation code"**.

### 13.3 Cleaning

The front of the housing can be cleaned with a clean dry or damp cloth.

## 14 Repair

### 14.1 General notes

- i** Repairs that are not described in these Operating Instructions must only be carried out directly by the manufacturer or by the service department.
- i** Always quote the serial number of the device when ordering spare parts! Installation instructions are included with the spare part.

### 14.2 Spare parts

- i** Information on accessories and spare parts that are currently available for the product can be found online at: [www.endress.com/spareparts\\_consumables](http://www.endress.com/spareparts_consumables) → access to specific device information → enter serial number.

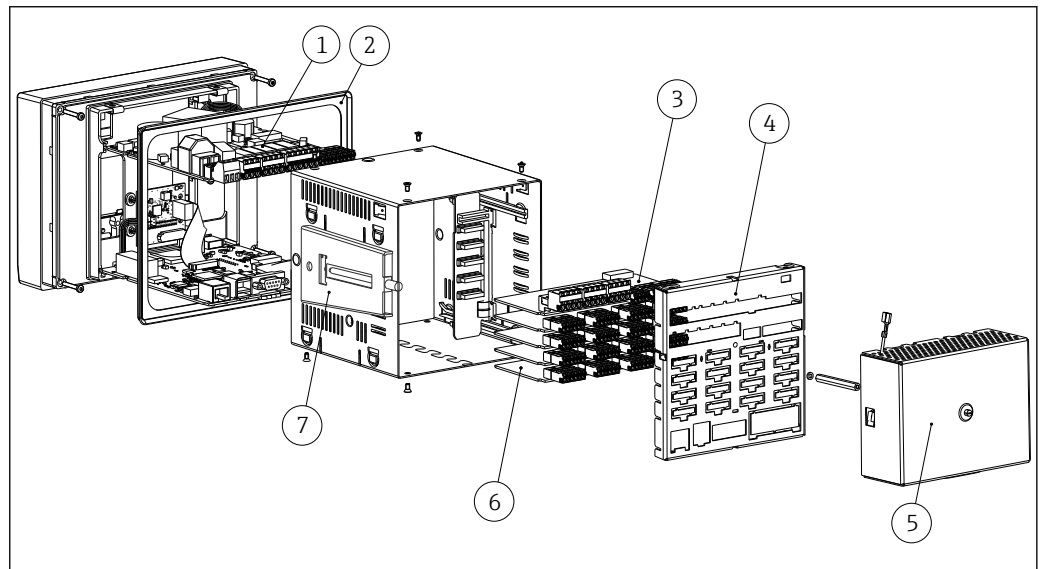

A0025589

17 Picture of spare parts, panel version

List of spare parts for panel version:

Item No.	Description	Order No.
1	Power unit 24 V AC/DC for slot 6	XPR0011-NB
1	Power unit 100-230 V AC (+/-10%) for slot 6	XPR0011-NA
2	Housing seal	XPR0011-A1
3	Digital card extension (8x digital inputs + 6x relays + 2x analog outputs) for slot 5 (rear panel must also be ordered with the extension)	XPR0011-A7
4	Rear panel analog (incl. imprint)	XPR0011-A2
4	Rear panel analog + digital (incl. imprint)	XPR0011-A3
5	Terminal cover can be sealed for panel-mounted housing	XPR0011-A5
6	Analog card (4 channels) for slots 1-5	XPR0011-A6
6	HART® card (4 channels) for slots 1-5	XPR0011-A4
7	Housing fastening unit, short (1 pc)	71035184

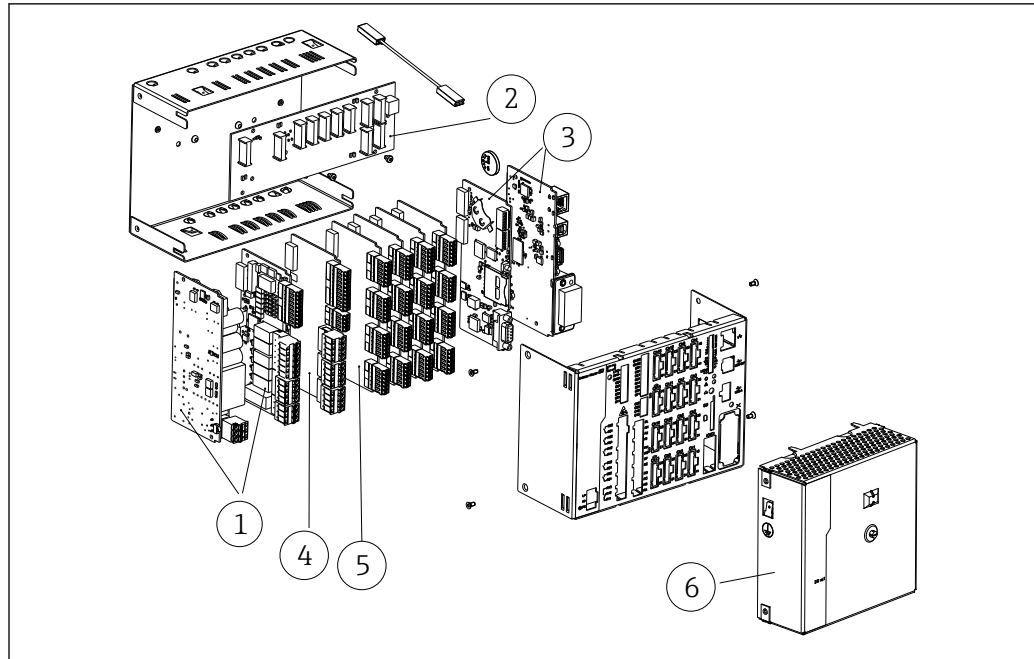

A0037149

18 Picture of spare parts, DIN rail version

List of spare parts, DIN rail version:

Item No.	Description	Order No.
1	Power unit 24 V AC/DC incl. relay for slot 6	XPR0011-ND
1	Power unit 100-230 V AC (+/-10%) incl. relay for slot 6	XPR0011-NC
2	Connection board, reverse side (DIN rail)	71412098
3	CPU card + software with interfaces for slot 0 (2-piece)	XPR0013-xxxxCx
4	Digital card extension (8x digital input + 6x relay + 2x analog output) for slot 5	XPR0011-A7
5	Analog card (4 channels) for slots 1-5	XPR0011-A6
5	HART® card (4 channels) for slots 1-5	XPR0011-A4
6	Terminal cover can be sealed for DIN rail version	XPR0011-A8

General spare parts list:

Item No.	Description	Order No.
	RS232/RS485 adapter set, DIN rail, 230 V AC, galvanic isolation + interface cable for PC/modem	RSG40A-S6
	RS232/RS485 adapter set, DIN rail, 150 V AC, galvanic isolation + interface cable for PC/modem	RSG40A-S7
	"Industrial Grade" SD card, industry standard, 1 GB	71213190
	<b>Terminals:</b>	
	Plug-in terminal, 3-pin for mains connection "N L PE" RM5.08 – orange color at slot 6	71123475
	3-pin terminal for power supply at slot 6	50078843
	Plug-in terminal, 3-pin FKC2.5/3-ST-5.08 for relay 1 (changeover) at slot 6	71037408
	Plug-in terminal, 4-pin FMC1.5/4-ST-3.5 for digital card extension slot 5 (analog outputs)	71037350

Item No.	Description	Order No.
	Plug-in terminal, 10-pin FMC1.5/10-ST-3.5 for digital card extension slot 5 (digital inputs)	71037351
	Plug-in terminal, 4-pin FKC2.5/4-ST-5.08 for relay 2+3 on slot 6 or relay 7+8 / 9+10 / 11+12 on slot 5	71037410
	Plug-in terminal, 6-pin FKC2.5/6-ST-5.08 for relay 4+5+6 at slot 6	71037411
	Plug-in terminal, 9-pin FMC1.5/9-ST-3.5 for digital inputs at slot 6	71037363
	Plug-in terminal, 6-pin FMC1.5/6-ST-3.5 for analog input at slot 1-5	51009211

*Product structure for option retrofit*

Item No.	Description	Order code
	<b>Option retrofit</b> (please enter the serial number)  DIN rail version: If one of the two CPU cards is replaced/removed, data may be lost and the time must be reset!	XPR0012- _ _ _ _
	<b>Software:</b> Without software application Mathematics Tele-alarm + mathematics Batch + mathematics Wastewater + RSB + tele-alarm + mathematics Energy software, water + steam + mathematics Tele-alarm + energy software + water + steam + mathematics	XPR0012-A _ _ _ XPR0012-B _ _ _ XPR0012-C _ _ _ XPR0012-D _ _ _ XPR0012-E _ _ _ XPR0012-F _ _ _ XPR0012-G _ _ _
	<b>Communication Master functionality:</b> None Standard + Modbus RTU/TCP master, max. 40 x analog	XPR0012- _ A _ _ XPR0012- _ B _ _
	<b>Communication Slave functionality:</b> None Standard + Modbus RTU/TCP slave, max. 40 x analog	XPR0012- _ _ A _ XPR0012- _ _ B _
	<b>Option:</b> Standard	XPR0012- _ _ _ A

 The software option can be enabled directly on the device. After ordering the option, instructions are delivered with a code that must be entered.

### 14.3 Return

The requirements for safe device return can vary depending on the device type and national legislation.

1. Refer to the website for more information:  
<http://www.endress.com/support/return-material>
2. Return the device if repairs or a factory calibration are required, or if the wrong device was ordered or delivered.

### 14.4 Disposal

#### 14.4.1 IT security

Observe the following instructions before disposal:

1. Clear data
2. Reset the device
3. Delete/change passwords

4. Delete user
5. Carry out alternative or complementary measures to destroy the storage medium

#### 14.4.2 Removing the measuring device

1. Switch off the device
2. Carry out the mounting and connection steps from the "Mounting the measuring device" and "Connecting the measuring device" sections in reverse order. Observe the safety instructions.

#### 14.4.3 Disposing of the measuring device



If required by the Directive 2012/19/EU on waste electrical and electronic equipment (WEEE), the product is marked with the depicted symbol in order to minimize the disposal of WEEE as unsorted municipal waste. Do not dispose of products bearing this marking as unsorted municipal waste. Instead, return them to Endress+Hauser for disposal under the applicable conditions.



## 15 Accessories

**i** Always quote the serial number of the device when ordering accessories! Installation instructions are provided with the accessory!

Various accessories, which can be ordered with the device or subsequently from Endress+Hauser, are available for the device. Detailed information on the order code in question is available from your local Endress+Hauser sales center or on the product page of the Endress+Hauser website: [www.endress.com](http://www.endress.com).

### 15.1 Device-specific accessories

Description	Order No.
"Industrial Grade" SD card, industry standard, 1GB	71213190
Field Data Manager analysis software with SQL database support (1 x workstation license, Professional version)	MS20-A1
OPC server software (full version on CD)	RXO20-11

Description	Order No.
<b>Accessories for RXU10 data manager</b>	RXU10- _ _
<b>Identifier:</b> Cable set RS232 for connection to PC or modem USB - RS232 converter Cable USB-A - USB-B, 1.8 m (5.9 ft) Configuration software "FieldCare Device Setup" + USB cable	RXU10-B _ RXU10-E _ RXU10-F _ RXU10-G _

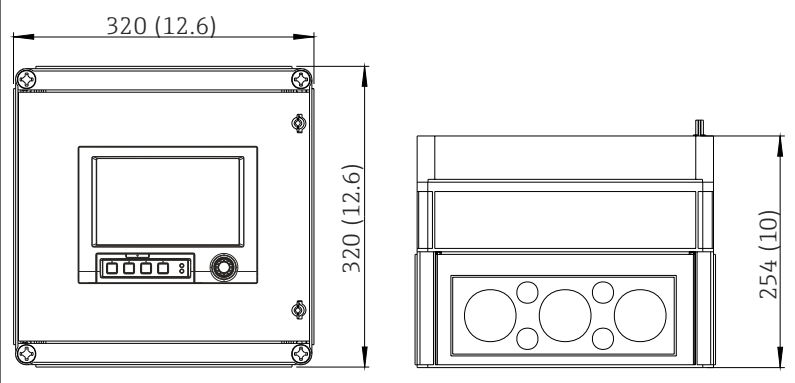
Description	Order No.
Field housing IP65 (for panel-mounted device)	RXU10-H _
 <p><b>19</b> Dimensions in mm (in)</p> <p style="text-align: right;">A0024766</p>	

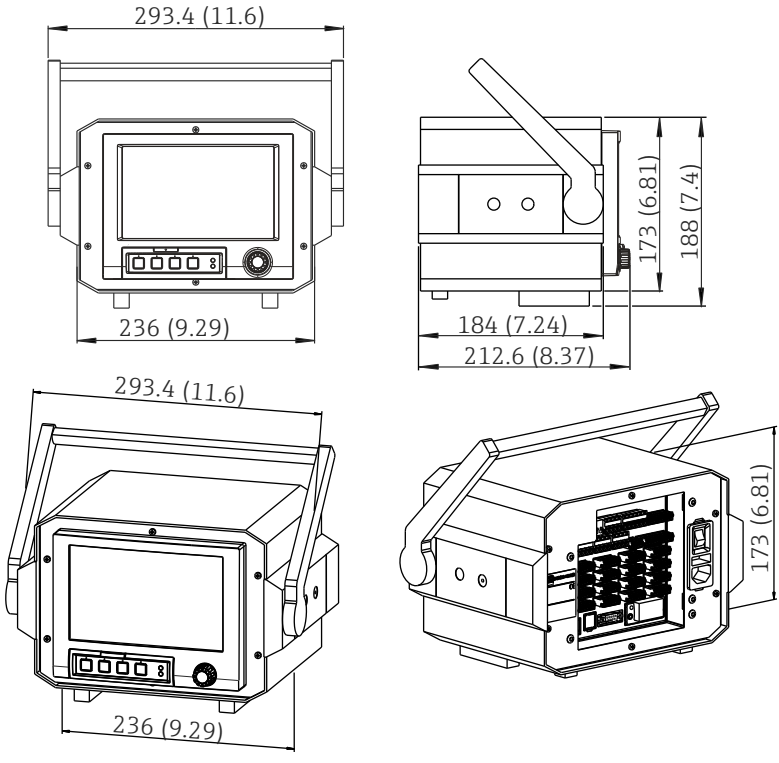
Description	Order No.
<p>Desktop housing (for panel-mounted device), cable with Schuko plug                      Desktop housing (for panel-mounted device), cable with US plug                      Desktop housing (for panel-mounted device), cable with Swiss plug</p>  <p>20 Dimensions in mm (in)</p>	<p>RXU10-I _                      RXU10-J _                      RXU10-K _</p>
<p><b>Version:</b>                      Standard                      Neutral</p>	<p>RXU10- _ 1                      RXU10- _ 2</p>

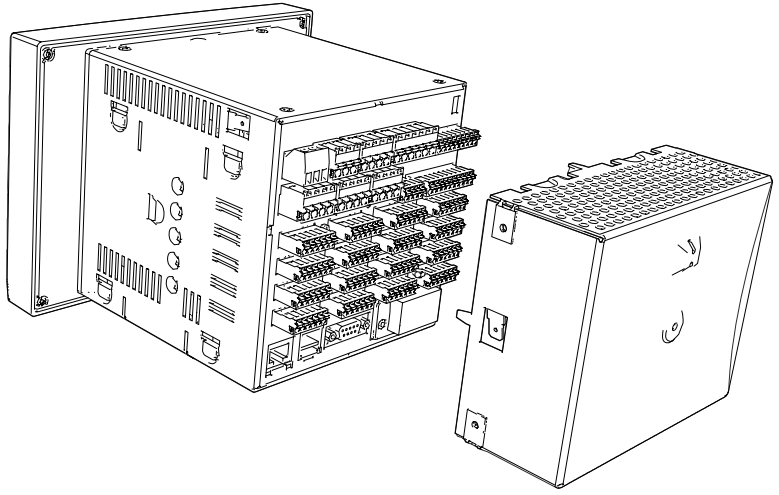
Description	Order No.
<p>Terminal cover can be sealed (for panel-mounted device)                      An optional terminal cover is available to prevent tampering at the device terminals and terminal temperature measurement.</p> 	<p>XPR0011-A5</p>

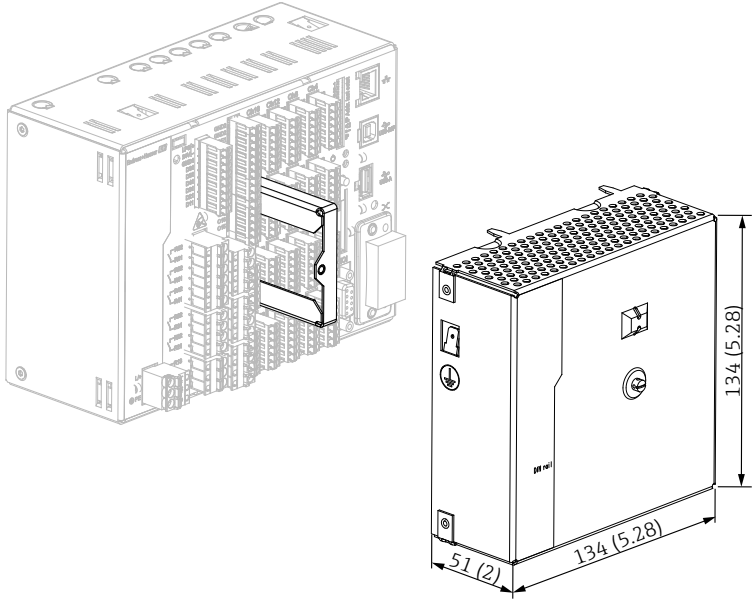
Description	Order No.
<p>Terminal cover can be sealed (for DIN rail version)                      An optional terminal cover is available to prevent tampering at the device terminals and terminal temperature measurement.</p>  <p style="text-align: right; font-size: small;">A0046633</p>	<p>XPRO011-A8</p>

## 16 Technical data

### 16.1 Function and system design

---

#### Measuring principle

Electronic acquisition, display, recording, analysis, remote transmission and archiving of analog and digital input signals as well as calculated values.

**Panel version:** Device with display and operating keys for installation in a panel or control cabinet door. There is also the option of operating it in a desktop housing or field housing.

**Panel version with stainless steel front:** Device with touch screen (no operating keys) for installation in a panel or a cabinet door. There is also the option of operating it in a desktop housing or field housing.

**DIN rail version:** Device without a display or operating keys for mounting on a DIN rail.

---

#### Measuring system

Multichannel data recording system with multicolor TFT display (order option, 178 mm (7 in) screen size), internal memory, external memory (SD card and USB stick), galvanically isolated universal inputs (U, I, TC, RTD, pulse, frequency), HART® inputs, digital inputs, transmitter power supply, limit relays, digital and analog outputs, communication interfaces (USB, Ethernet, RS232/485), optionally available with Modbus, Profibus DP or PROFINET I/O or EtherNet/IP.

An Essential Version of the Field Data Manager (FDM) software is included for SQL-supported data analysis at the PC.

 The number of inputs available in the basic device can be individually increased using a maximum of 5 plug-in cards. The device supplies power directly to connected two-wire transmitters. The device is configured and operated via the navigator (jog/shuttle dial) or by touchscreen (optional) using the integrated Web server and a PC, an external USB keyboard or mouse or with the FieldCare / DeviceCare configuration software. Online help supports the user during local operation.

 **Ex version:**

- The hazardous area version (Ex version) is only available in conjunction with the stainless steel front and touch control.
  - In this version, the SD card is integrated in the device and cannot be removed. The card can be read out using the Field Data Manager (FDM) software supplied via USB or Ethernet or via WebDAV.
- 

#### Application packages / software options

In the standard version, the Advanced Data Manager has a variety of functions, including an end-to-end safety concept to meet the requirements of FDA 21 CFR Part 11. The following application packages are available to help users meet the requirements of their applications and save time:

- Mathematics
- Telealarm
- Batch management
- Wastewater + RSB (rain spillway basin)
- Energy calculation

The application packages contain the standard functions and the specific package functions. The individual packages can be largely combined as the user requires. The application packages can also be activated retroactively by entering the activation code.

### Standard functions

- Signal analysis: external, 1 min to 12 h, day, week, month, year
- Web server
- User administration compliant with FDA 21 CFR Part 11
- Event log/audit trail
- Process screen
- Operation time counter
- Text entry/comments
- Change language
- Time synchronization
- Linearization
- Access protection through release code
- E-mail notification in event of alarms and limit violation
- Encrypted e-mail transmission via SSL (TLS)
- Operation via external USB keyboard and mouse
- External USB or network printer

### Mathematics

With the mathematics package, measured values of the inputs or the results of other math channels can be linked mathematically. A formula with up to 200 characters can be created using a formula editor. Once entered, the user can then check the plausibility of the formula.

Functions:

- 12 math channels
- Mathematics functions via formula editor
- Basic arithmetic operations, relational operators, logic operations and functions

### Telealarm software

The Telealarm software facilitates user mobility, allowing users to respond to events while they are on the road. E-mails or SMS messages triggered by process alarms or other important process events can be sent to several recipients simultaneously or automatically forwarded to a recipient/destination. Messages can be confirmed, relays controlled remotely and current values queried by cellular phone. The Advanced Data Manager with GSM (GPRS) or Ethernet is ideal both for environmental applications to monitor unstaffed outstations, and for tank monitoring applications.

 The Telealarm software contains the mathematics package.

Functions:

- Advanced SMS/e-mail notification in the event of an alarm
- Instantaneous values queried by cellular phone
- Remote relay switching
- Alarm confirmation by SMS

### Batch software

Batch management allows users to reliably record and visualize discontinuous processes. User-definable or externally controlled analysis intervals are possible for up to four batches simultaneously. Batches are assigned batch-specific values and the measured data, the start, end and duration of every batch, along with the current batch status, are displayed on the device and in the Field Data Manager software. At the end of the batch, batch information is automatically printed out directly at the device (USB or network printer) or is printed out via a PC with the Field Data Manager software.

 The batch software contains the mathematics package.

Functions:

- Batch report for 4 batches simultaneously
- USB barcode reader
- Automatic batch printout
- Preset counter

### **Wastewater + RSB (rain spillway basin)**

The water/wastewater software supports operations monitoring of the water/wastewater sewage network to obtain information about the quality and efficiency of the plant. The daily, weekly, monthly and yearly maximum and minimum value is determined per quantity channel. Infiltration water recording and the monitoring of rain spillway basins for reservoir and overflow events are also functions of this software option.

 The water/wastewater software contains the mathematics package and the telealarm software.

Functions:

- Rain spillway basin (reservoir/overflow)
- Highest and lowest values for quantities
- Highest and lowest values from ¼-hourly averages
- Determination of infiltration water

### **Energy package (water + steam)**

The energy package allows users to calculate the mass and energy flow in water and steam applications on the basis of the flow, pressure and temperature (or temperature differential). Furthermore, energy calculations are also possible using glycol-based refrigerant media.

By balancing the results against one another or by linking the results to other input variables (e.g. gas flow, electr. energy), users can calculate overall balances, efficiency levels etc. These values are important indicators for the quality of the process and form the basis for process optimization and maintenance.

The internationally recognized standard IAPWS-IF 97 is used to calculate the thermodynamic state variables of water and steam.

In the energy software, it is also possible to compensate differential pressure flow measurement ("DP-Flow"). The calculation of flow based on the differential pressure method is a special form of flow measurement. Volumes or mass flow rates that are determined using the DP method require specific correction. By solving the calculation equations listed in the standard in an iterative manner, highly accurate results for DP flow measurements can be achieved. The measurement (orifice plate, nozzle, Venturi pipe) is performed in accordance with ISO5167. Flow measurement based on the dynamic pressure method uses the interrelation between differential pressure and flow.

 The energy package contains the mathematics package.

Additional functions:

- 12 math channels  
(Channels 1-8: energy-specific formulas and formula editor, channels 9-12: formula editor)
- Heat quantity + mass calculation for water and steam applications
- Efficiency calculation

### **TrustSens Calibration Monitoring**

 Available in conjunction with iTHERM TrustSens TM371 / TM372.

Application package :

- Up to 20 iTHERM TrustSens TM371 / TM372 can be monitored via the HART interface
- Self-calibration data displayed on screen or via the Web server
- Generation of a calibration history
- Creation of a calibration protocol as an RTF file directly at the RSG45
- Evaluation, analysis and further processing of the calibration data using "Field Data Manager" (FDM) analysis software

---

## Dependability

### Reliability

Depending on the device version, the mean time between failures (MTBF) is between 52 years and 16 years (calculated based on SN29500 standard at 40°C)

### Maintainability

Battery-backed time and data memory. It is advisable to have the backup battery replaced by a service technician after 10 years.

### Real time clock (RTC)

- Automatic or manual summer time changeover
- Battery buffer. It is advisable to have the backup battery replaced by a service technician after 10 years.
- Drift: <10 min./year.
- Time synchronization possible via SNTP or via digital input.

### Standard diagnostic functions as per Namur NE 107

The diagnostic code is made up of the error category as per Namur NE 107 and the message number.

- Cable open circuit, short-circuit
- Incorrect wiring
- Internal device errors
- Overrange/underrange detection
- Ambient temperature out-of-range detection

### Device error/alarm relay

One relay can be used as an alarm relay. If the device detects a system error (e.g. hardware defect) or a fault (e.g. cable open circuit), the selected relay switches.

This "alarm relay" switches if the device status is "F" (Failure). If the device status is "M" (Maintenance required), the alarm relay does not switch.

### Safety

Recorded data are saved in a tamper-proof format and can be exported and archived with manipulation protection using the Field Data Manager software.

## 16.2 Input

---

### Measured variables

#### Analog universal inputs

Standard version without universal inputs. Optional multifunction cards (slot 1-5) with 4 universal inputs (4/8/12/16/20) each.

You are free to choose between the following measured variables for each universal input: U, I, RTD, TC, pulse input or frequency input.

Integration of input variable for totalization e.g. flow (m<sup>3</sup>/h) in quantity (m<sup>3</sup>).

### HART® inputs

Standard version without HART® inputs. Optional HART® input cards (slot 1-5) with 4 inputs (4/8/12/16/20) each.

Both the digital HART® values and the 4 to 20 mA signal can be evaluated at every input.

The 4 HART® values (PV, SV, TV, QV) of a sensor can be evaluated and the analog HART® value (PV) can be measured via the digital HART® signal. Up to 40 digital HART® values can be recorded in total. It is possible to access the HART® sensor in the field from a PC tool (e.g. FieldCare). In this way, the sensor can be configured from the control room and the status information of the sensor can be analyzed/displayed. The Memograph M acts as a HART® Gateway.

 Access to the connected sensors is only possible if the device is connected by Ethernet. Port 5094 must be open in the firewall.

### Digital inputs

Standard version: 6 digital inputs

Optional digital card (slot 5): 8 additional digital inputs, 6 additional relays and 2 analog outputs

### Mathematics channels

12 math channels (optional). Mathematics functions can be freely edited via a formula editor.

Integration of calculated values e.g. for totalization.

### Limit values

60 limit values (individual channel assignment)

### Calculated process variables

The values of the universal and HART® inputs can be used to perform calculations in the math channels.

The results of the math channels can also be used for calculations in other math channels.

---

Measuring range      According to IEC 60873-1: An additional display error of ±1 digit is permitted for every measured value.

*User-definable measuring ranges per universal input of the multifunction card:*

Measured variable	Measuring range	Maximum measured error of measuring range (oMR), temperature drift	Input resistance
Current (I)	0 to 20 mA; 0 to 20 mA quadratic 0 to 5 mA 4 to 20 mA; 4 to 20 mA quadratic ±20 mA Overrange: up to 22 mA or -22 mA	±0.1% oMR Temperature drift: ±0.01%/K oMR	Load: 50 Ω ±1 Ω
Voltage (U) >1 V	0 to 10 V; 0 to 10 V quadratic 0 to 5 V 1 to 5 V; 1 to 5 V quadratic ±10 V ±30 V	±0.1% oMR Temperature drift: ±0.01%/K oMR	≥1 MΩ
Voltage (U) ≤1 V	0 to 1 V; 0 to 1 V quadratic ±1 V ±150 mV	±0.1% oMR Temperature drift: ±0.01%/K oMR	≥2.5 MΩ



Measured variable	Measuring range	Maximum measured error of measuring range (oMR), temperature drift	Input resistance
Resistance thermometer (RTD)	Pt100: -200 to 850 °C (-328 to 1562 °F) (IEC 60751:2008, $\alpha=0.00385$ ) Pt100: -200 to 510 °C (-328 to 950 °F) (JIS C 1604:1984, $\alpha=0.003916$ ) Pt100: -200 to 850 °C (-328 to 1562 °F) (GOST 6651-94, $\alpha=0.00391$ ) Pt500: -200 to 850 °C (-328 to 1562 °F) (IEC 60751:2008, $\alpha=0.00385$ ) Pt500: -200 to 510 °C (-328 to 950 °F) (JIS C 1604:1984, $\alpha=0.003916$ ) Pt1000: -200 to 600 °C (-328 to 1112 °F) (IEC 60751:2008, $\alpha=0.00385$ ) Pt1000: -200 to 510 °C (-328 to 950 °F) (JIS C 1604:1984, $\alpha=0.003916$ )	4-wire: $\pm 0.1\%$ oMR 3-wire: $\pm(0.1\%$ oMR + 0.8 K) 2-wire: $\pm(0.1\%$ oMR + 1.5 K) Temperature drift: $\pm 0.01\%/K$ oMR	
	Cu50: -50 to 200 °C (-58 to 392 °F) (GOST 6651-94, $\alpha=4260$ ) Cu50: -200 to 200 °C (-328 to 392 °F) (GOST 6651-94, $\alpha=4280$ ) Pt50: -200 to 1100 °C (-328 to 2012 °F) (GOST 6651-94, $\alpha=0.00391$ ) Cu100: -200 to 200 °C (-328 to 392 °F) (GOST 6651-94, $\alpha=4280$ )	4-wire: $\pm 0.2\%$ oMR 3-wire: $\pm(0.2\%$ oMR + 0.8 K) 2-wire: $\pm(0.2\%$ oMR + 1.5 K) Temperature drift: $\pm 0.02\%/K$ oMR	
	Pt46: -200 to 1100 °C (-328 to 2012 °F) (GOST 6651-94, $\alpha=0.00391$ ) Cu53: -200 to 200 °C (-328 to 392 °F) (GOST 6651-94, $\alpha=4280$ )	4-wire: $\pm 0.3\%$ oMR 3-wire: $\pm(0.3\%$ oMR + 0.8 K) 2-wire: $\pm(0.3\%$ oMR + 1.5 K) Temperature drift: $\pm 0.02\%/K$ oMR	
Thermocouples (TC)	Type J (Fe-CuNi): -210 to 1200 °C (-346 to 2192 °F) (IEC 60584:2013) Type K (NiCr-Ni): -270 to 1300 °C (-454 to 2372 °F) (IEC 60584:2013) Type L (NiCr-CuNi): -200 to 800 °C (-328 to 1472 °F) (GOST R8.585:2001) Type L (Fe-CuNi): -200 to 900 °C (-328 to 1652 °F) (DIN 43710-1985) Type N (NiCrSi-NiSi): -270 to 1300 °C (-454 to 2372 °F) (IEC 60584:2013) Type T (Cu-CuNi): -270 to 400 °C (-454 to 752 °F) (IEC 60584:2013)	$\pm 0.1\%$ oMR from -100 °C (-148 °F) $\pm 0.1\%$ oMR from -130 °C (-202 °F) $\pm 0.1\%$ oMR from -100 °C (-148 °F) $\pm 0.1\%$ oMR from -100 °C (-148 °F) $\pm 0.1\%$ oMR from -100 °C (-148 °F) $\pm 0.1\%$ oMR from -200 °C (-328 °F) Temperature drift: $\pm 0.01\%/K$ oMR	$\geq 1$ M $\Omega$
	Type A (W5Re-W20Re): 0 to 2500 °C (32 to 4532 °F) (ASTME 988-96) Type B (Pt30Rh-Pt6Rh): 42 to 1820 °C (107.6 to 3308 °F) (IEC 60584:2013) Type C (W5Re-W26Re): 0 to 2315 °C (32 to 4199 °F) (ASTME 988-96) Type D (W3Re-W25Re): 0 to 2315 °C (32 to 4199 °F) (ASTME 988-96) Type R (Pt13Rh-Pt): -50 to 1768 °C (-58 to 3214 °F) (IEC 60584:2013) Type S (Pt10Rh-Pt): -50 to 1768 °C (-58 to 3214 °F) (IEC 60584:2013)	$\pm 0.15\%$ oMR from 500 °C (932 °F) $\pm 0.15\%$ oMR from 600 °C (1112 °F) $\pm 0.15\%$ oMR from 500 °C (932 °F) $\pm 0.15\%$ oMR from 500 °C (932 °F) $\pm 0.15\%$ oMR from 100 °C (212 °F) $\pm 0.15\%$ oMR from 100 °C (212 °F) Temperature drift: $\pm 0.01\%/K$ oMR	$\geq 1$ M $\Omega$
Pulse input (I) <sup>1)</sup>	Min. pulse length 40 $\mu$ s, max. 12.5 kHz; 0 to 7 mA = LOW; 13 to 20 mA = HIGH		Load: 50 $\Omega$ $\pm 1$ $\Omega$
Frequency input (I) <sup>1)</sup>	0 to 10 kHz, overrange: up to 12.5 kHz; 0 to 7 mA = LOW; 13 to 20 mA = HIGH	$\pm 0.02\%$ @ $f < 100$ Hz of reading $\pm 0.01\%$ @ $f \geq 100$ Hz of reading Temperature drift: 0.01% of measured value over the entire temperature range	

1) If a universal input is used as a frequency or pulse input, a series resistor must be used in series connection with the voltage source. Example: 1.2 k $\Omega$  series resistor at 24 V

#### Current measuring range of the HART® card:

Measured variable	Measuring range	Maximum measured error of measuring range (oMR), temperature drift	Input impedance
Current (I)	4 to 20 mA Overrange: up to 22 mA	$\pm 0.1\%$ oMR Temperature drift: $\pm 0.01\%/K$ oMR	Load: 10 $\Omega$ $\pm 1$ $\Omega$

**Maximum load and additional input parameters of the multifunction cards**

Limit values for input voltage and current as well as cable open circuit detection/line influence/temperature compensation:

Measured variable	Limit values (steady-state, without destroying input)	Cable open circuit detection/line influence/temperature compensation
Current (I)	Maximum permitted input voltage: 2.5 V Maximum permitted input current: 50 mA	4 to 20 mA range with disengageable cable open circuit monitoring to NAMUR NE43. The following error ranges apply when NAMUR NE43 monitoring is switched on: ≤3.8 mA: underrange ≥20.5 mA: overrange ≤ 3.6 mA or ≥ 21.0 mA: open circuit (display shows: - - - -)
Pulse, frequency (I)	Maximum permitted input voltage: 2.5 V Maximum permitted input current: 50 mA	No cable open circuit monitoring
Voltage (U) >1 V	Maximum permitted input voltage: 35 V	1 to 5 V range with disengageable cable open circuit monitoring: <0.8 V or >5.2 V: cable open circuit (display shows: - - - -)
Voltage (U) ≤1 V	Maximum permitted input voltage: 24 V	
Resistance thermometer (RTD)	Measuring current: ≤1 mA	Maximum barrier resistance (or line resistance): 4-wire: max. 200 Ω; 3-wire: max. 40 Ω Maximum influence of barrier resistance (or line resistance) for Pt100, Pt500 and Pt1000: 4-wire: 2 ppm/Ω, 3-wire: 20 ppm/Ω Maximum influence of barrier resistance (or line resistance) for Pt46, Pt50, Cu50, Cu53, Cu100 and Cu500: 4-wire: 6 ppm/Ω, 3-wire: 60 ppm/Ω Cable open circuit monitoring if any connection is interrupted.
Thermocouples (TC)	Maximum permitted input voltage: 24 V	Influence of line resistance: <0.001%/Ω Error, internal temperature compensation: ≤ 2 K

**Maximum load and additional input parameters of the HART® cards**

Limit values for input voltage and current as well as cable open circuit detection:

Measured variable	Limit values (steady-state, without destroying input)	Cable open circuit detection
Current (I)	Maximum permitted input voltage: 0.5 V Maximum permitted input current: 50 mA	4 to 20 mA range with disengageable cable open circuit monitoring to NAMUR NE43. The following error ranges apply when NAMUR NE43 monitoring is switched on: ≤3.8 mA: underrange ≥20.5 mA: overrange ≤ 3.6 mA or ≥ 21.0 mA: open circuit (display shows: - - - -)

**Scan rate**

Current/voltage/pulse/frequency input: 100 ms per channel

Thermocouples and resistance thermometers: 1 s per channel

**Data storage / save cycle**

Choose from the following for the memory cycle: off / 100 ms / 1s / 2s / 3s / 4s / 5s / 10s / 15s / 20s / 30s / 1min / 2min / 3min / 4min / 5min / 10min / 15min / 30min / 1h

 Highspeed storage (100 ms) can be selected for up to 8 channels in Group 1 only.  
Highspeed storage is not available in the energy package (option).

**Typical logging duration**

**Prerequisites for following tables:**

- No limit value violation / integration
- Digital input not used
- Signal analysis 1: off, 2: day, 3: month, 4: year
- No active mathematics channels

 Frequent entries in the event log reduce the memory availability!

256 MB internal memory:

Analog inputs	Channels in groups	Storage cycle (weeks, days, hours)				
		5 min	1 min	30 s	10 s	1 s
1	1/0/0/0/0/0/0/0/0/0	1796, 6, 13	362, 5, 17	181, 4, 9	60, 4, 3	6, 0, 10
4	4/0/0/0/0/0/0/0/0/0	1319, 2, 23	267, 5, 17	134, 1, 2	44, 5, 10	4, 3, 8
8	4/4/0/0/0/0/0/0/0/0	661, 4, 3	133, 6, 21	67, 0, 16	22, 2, 17	2, 1, 16
12	4/4/4/0/0/0/0/0/0/0	441, 3, 8	89, 2, 9	44, 5, 3	14, 6, 11	1, 3, 10
20	4/4/4/4/4/0/0/0/0/0	265, 0, 15	53, 4, 7	26, 5, 21	8, 6, 16	0, 6, 6
40	4/4/4/4/4/4/4/4/4/4	132, 4, 8	26, 5, 16	13, 2, 23	4, 3, 8	0, 3, 3

External memory, 1 GB SD card:

Analog inputs	Channels in groups	Storage cycle (weeks, days, hours)				
		5 min	1 min	30 s	10 s	1 s
1	1/0/0/0/0/0/0/0/0/0	12825, 5, 20	2580, 4, 18	1291, 2, 5	430, 4, 14	43, 0, 12
4	4/0/0/0/0/0/0/0/0/0	8672, 5, 12	1749, 6, 13	875, 6, 13	292, 1, 8	29, 1, 14
8	4/4/0/0/0/0/0/0/0/0	4343, 1, 1	875, 1, 17	438, 0, 6	146, 0, 17	14, 4, 7
12	4/4/4/0/0/0/0/0/0/0	2896, 6, 13	583, 3, 21	292, 0, 6	97, 2, 20	9, 5, 4
20	4/4/4/4/4/0/0/0/0/0	1738, 6, 4	350, 1, 3	175, 1, 14	58, 3, 2	5, 5, 22
40	4/4/4/4/4/4/4/4/4/4	869, 5, 0	175, 0, 15	87, 4, 7	29, 1, 13	2, 6, 11

 The available storage capacity of the internal and external memory can be displayed in the main menu under "**Diagnostics → Device information → Memory information**". The storage capacity depends on the specific device set-up.

**Converter resolution**

24 bit

**Totalization**

The interim, daily, weekly, monthly and yearly value and the total value can be determined (15-digit, 64 bit).

**Analysis**

Recording of quantity/operating time (standard function), also a min/max/median analysis within the set time frame.

Digital inputs

<b>Input level</b>	Logical "0" (corresponds to -3 to +5 V), activation with logical "1" (corresponds to +12 to +30 V)
<b>Input frequency</b>	max. 25 Hz

<b>Pulse length</b>	Min. 20 ms (pulse counter)
<b>Pulse length</b>	Min. 100 ms (control input, messages, operating time)
<b>Input current</b>	max. 2 mA
<b>Input voltage</b>	Max. 30 V

**Selectable functions**

- Functions of the digital input: control input, ON/OFF event, pulse counter (15-digit, 64 bit), operational time, event+operation time, quantity from time, Profibus DP, EtherNet/IP, PROFINET.
- Functions of the control input: start recording, screensaver on, lock setup, time synchronization, change group, limit value monitoring on/off, individual LV on/off, block keyboard/navigator, start/stop analysis.  
Additionally for the batch software option: reset batch number, batch limit values on/off.

## 16.3 Output

**Auxiliary voltage output**

The auxiliary voltage output can be used for loop power supply or to control the digital inputs. The auxiliary voltage is short-circuit proof and galvanically isolated.

<b>Output voltage</b>	24 V <sub>DC</sub> ±15%
<b>Output current</b>	Max. 250 mA

**Analog and pulse outputs**

**Number**

Optional digital card (slot 5): 2 analog outputs which can be operated as current or pulse outputs.

**Analog output (current output)**

Output current: 0/4 to 20 mA with 10% overrange

Max. output voltage: approx. 16 V

Accuracy: ≤0.1% of end of range value

Temperature drift: ≤0.015%/K of end of range value

Resolution: 13 Bit

Load: 0 to 500 Ω

Error signal as per NAMUR NE43: 3.6 mA or 21 mA can be configured

**Digital output (pulse output)**

Output voltage:

≤5 V corresponds to LOW

≥12 V corresponds to HIGH

Short-circuit proof (maximum 25 mA)

Speed: max. 1000 pulses/s

Pulse width: 0.5 to 1000 ms

 The pulse pause is at least as long as the pulse width.

Load:  $\geq 1 \text{ k}\Omega$

Relay outputs

A mix of low voltage (230 V) and safety extra low voltage (SELV circuits) is not permitted at the connections of the relay contacts.

**Alarm relay**

1 alarm relay with changeover contact.

**Standard relay**

5 relays with NO contact, e.g. for limit value messages (can be configured as NC contact).

**Optional relays**

Optional digital card (slot 5): 6 additional relays with NO contact e.g. for limit value alarms (can be configured as an NC contact).

**Relay switching capacity**

- Max. relay switching capacity: 3 A @ 30 V DC
- Max. relay switching capacity: 3 A @ 250 V AC
- Min. switching load: 300 mW

**Switching cycles**

$>10^5$

Galvanic isolation

*All inputs and outputs are galvanically isolated from each other and designed for the following test voltages:*

	Relay	Digital in	Analog in/HART®	Analog out	Ethernet	RS232/RS485	USB	Auxiliary voltage output
<b>Relay</b>	500 V <sub>DC</sub>	2 kV <sub>DC</sub>	2 kV <sub>DC</sub>	2 kV <sub>DC</sub>	2 kV <sub>DC</sub>	2 kV <sub>DC</sub>	2 kV <sub>DC</sub>	2 kV <sub>DC</sub>
<b>Digital in</b>	2 kV <sub>DC</sub>	500 V <sub>DC</sub> but: <sup>1)</sup>	500 V <sub>DC</sub>	500 V <sub>DC</sub>	500 V <sub>DC</sub>	500 V <sub>DC</sub>	500 V <sub>DC</sub>	500 V <sub>DC</sub>
<b>Analog in/HART®</b>	2 kV <sub>DC</sub>	500 V <sub>DC</sub>	500 V <sub>DC</sub>	500 V <sub>DC</sub>	500 V <sub>DC</sub>	500 V <sub>DC</sub>	500 V <sub>DC</sub>	500 V <sub>DC</sub>
<b>Analog out</b>	2 kV <sub>DC</sub>	500 V <sub>DC</sub>	500 V <sub>DC</sub>	500 V <sub>DC</sub>	500 V <sub>DC</sub>	500 V <sub>DC</sub>	500 V <sub>DC</sub>	500 V <sub>DC</sub>
<b>Ethernet</b>	2 kV <sub>DC</sub>	500 V <sub>DC</sub>	500 V <sub>DC</sub>	500 V <sub>DC</sub>	-	500 V <sub>DC</sub>	500 V <sub>DC</sub>	500 V <sub>DC</sub>
<b>RS232/RS485</b>	2 kV <sub>DC</sub>	500 V <sub>DC</sub>	500 V <sub>DC</sub>	500 V <sub>DC</sub>	500 V <sub>DC</sub>	-	500 V <sub>DC</sub>	500 V <sub>DC</sub>
<b>USB</b>	2 kV <sub>DC</sub>	500 V <sub>DC</sub>	500 V <sub>DC</sub>	500 V <sub>DC</sub>	500 V <sub>DC</sub>	500 V <sub>DC</sub>	Galvanically connected	500 V <sub>DC</sub>
<b>Auxiliary voltage output</b>	2 kV <sub>DC</sub>	500 V <sub>DC</sub>	500 V <sub>DC</sub>	500 V <sub>DC</sub>	500 V <sub>DC</sub>	500 V <sub>DC</sub>	500 V <sub>DC</sub>	-

1) Test voltage applies between inputs on power unit (terminals D11 to D61) to inputs on optional digital card (terminals D71 to DE1). The inputs are galvanically connected on the same plug-in connector.

## Cable specification

**Cable specification, spring terminals**

All connections on the rear of the device are designed as pluggable screw or spring terminal blocks with reverse polarity protection. This makes the connection very quick and easy. The spring terminals are unlocked with a slotted screwdriver (size 0).

Please note the following when connecting:

- Wire cross-section, auxiliary voltage output, digital I/O and analog I/O: max. 1.5 mm<sup>2</sup> (14 AWG) (spring terminals)
- Wire cross-section, mains: max. 2.5 mm<sup>2</sup> (13 AWG) (screw terminals)
- Wire cross-section, relays: max. 2.5 mm<sup>2</sup> (13 AWG) (spring terminals)
- Stripping length: 10 mm (0.39 in)

 No ferrules must be used when connecting flexible wires to spring terminals.

**Shielding and grounding**

Optimum electromagnetic compatibility (EMC) can only be guaranteed if the system components and, in particular, the lines - both sensor lines and communication lines - are shielded and the shield forms as complete a cover as possible. A shielded line must be used for sensor lines that are longer than 30 m. A shield coverage of 90% is ideal. In addition, make sure not to cross sensor lines and communication lines when routing them. Connect the shield as often as possible to the reference ground to ensure optimum EMC protection for the different communication protocols and the connected sensors.

To comply with requirements, three different types of shielding are possible:

- Shielding at both ends
- Shielding at one end on the supply side with capacitance termination at the device
- Shielding at one end on the supply side

Experience shows that the best results with regard to EMC are achieved in most cases in installations with one-sided shielding on the supply side (without capacitance termination at the device). Appropriate internal device wiring measures must be taken to allow unrestricted operation when EMC interference is present. These measures have been taken into account for this device. Operation in the event of disturbance variables as per NAMUR NE21 is thus guaranteed.

Where applicable, national installation regulations and guidelines must be observed during the installation! Where there are large differences in potential between the individual grounding points, only one point of the shielding is connected directly with the reference ground.

 If the shielding of the cable is grounded at more than one point in systems without potential matching, mains frequency equalizing currents can occur. These can damage the signal cable or significantly impact signal transmission. In such cases the shielding of the signal cable is to be grounded on one side only, i.e. it may not be connected to the ground terminal of the housing. The shield that is not connected should be insulated!

## 16.4 Power supply

## Connections

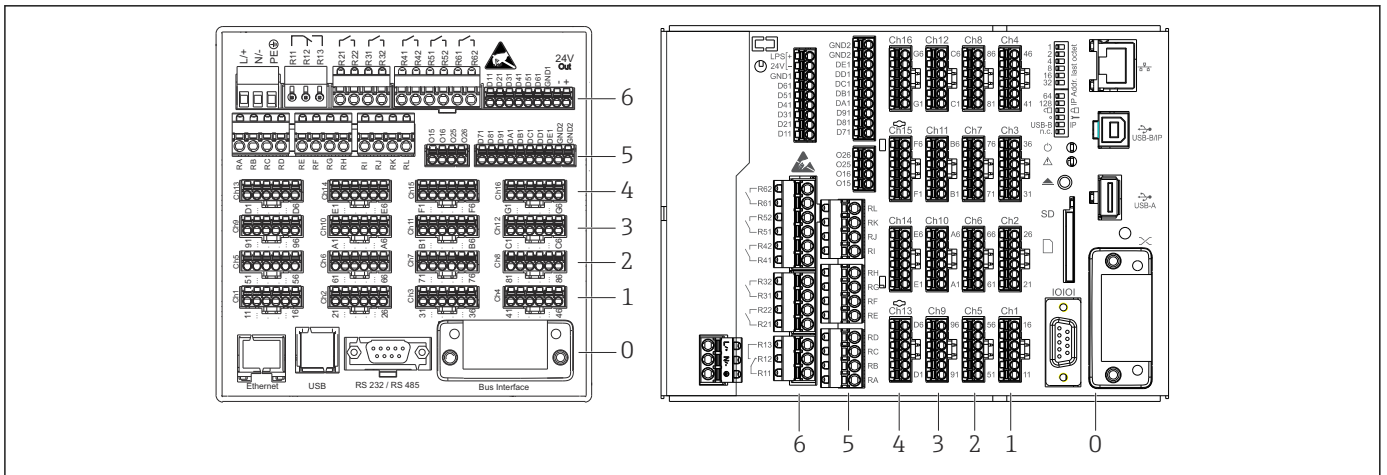

A0024605

21 Connections: back of device, panel version (left), DIN rail version (right)

- 6 Slot 6: Power supply with relays
- 5 Slot 5: Multifunction card or HART® card (channels 17-20) or digital card
- 4 Slot 4: Multifunction card or HART® card (channels 13-16)
- 3 Slot 3: Multifunction card or HART® card (channels 9-12)
- 2 Slot 2: Multifunction card or HART® card (channels 5-8)
- 1 Slot 1: Multifunction card or HART® card (channels 1-4)
- 0 Slot 0: CPU card with interfaces

Supply voltage

- Extra-low voltage power supply unit  $\pm 24$  V AC/DC (-10% / +15%) 50/60Hz
- Low voltage power supply unit 100 to 230 V AC ( $\pm 10\%$ ) 50/60Hz

**i** Overcurrent protection (rated current  $\leq 10$  A) must be installed for the power cable.

Power consumption

- 100 to 230 V: max. 47 VA
- 24 V: max. 30 VA

The power actually consumed depends on the individual operating state and the device version (LPS, USB, brightness of screen, number of channels, etc). The active power here is approx. 3 W to 25 W.

Power supply failure

Battery-backed time and data memory. The device starts automatically following a power failure.

Electrical connection

Details about the electrical connection:  $\rightarrow$  17

Electrical connection, terminal assignment

**i** All connection examples are illustrated using the panel version. The connections on the DIN rail version are identical.

Circuit diagram

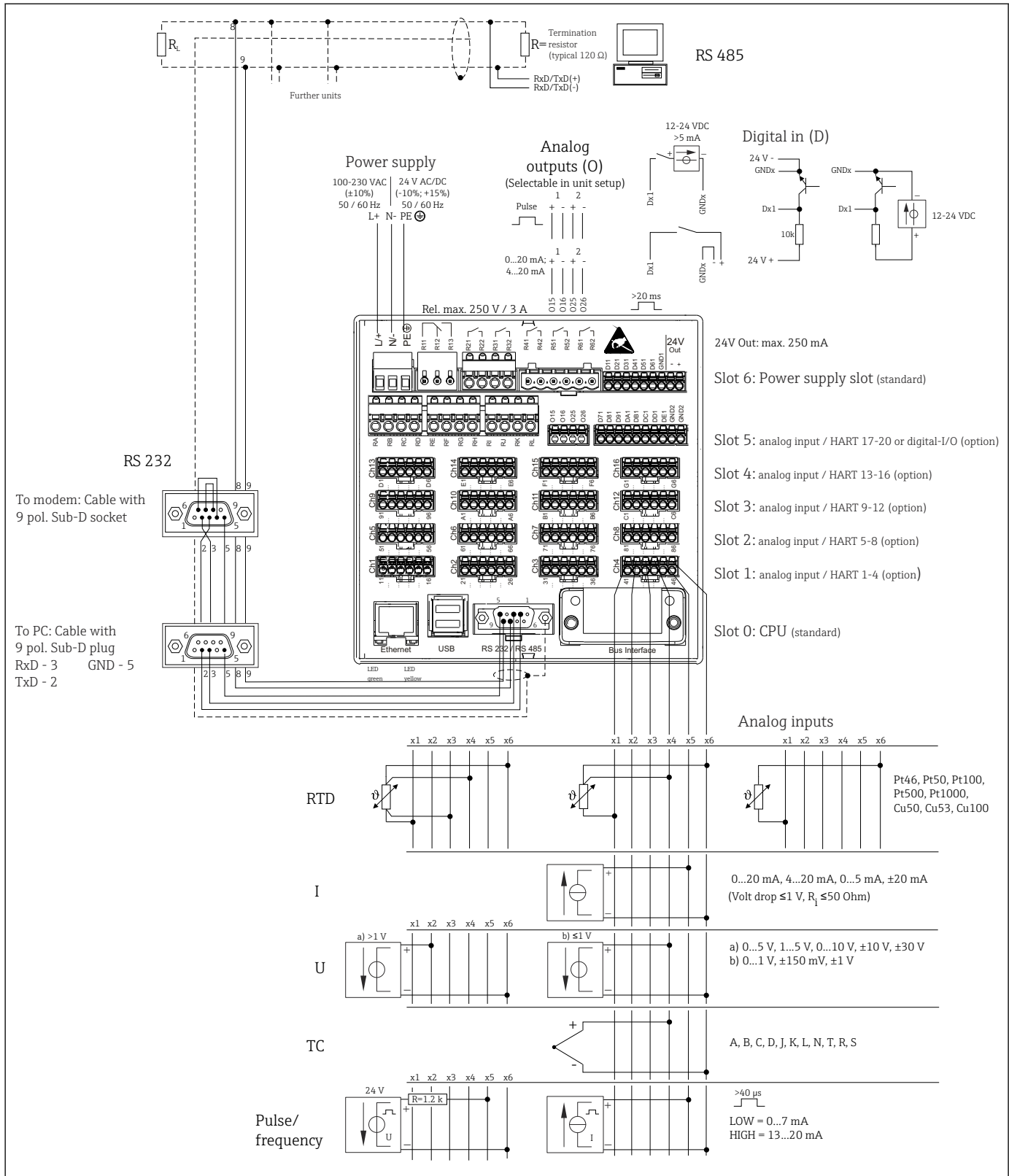

A0026669-EN

22 For connection examples of the HART® inputs (optional), see the Operating Instructions → 25



Supply voltage (power unit, slot 6)

Power unit type	Terminal		
100-230 VAC	L+	N-	PE
	Phase L	Zero conductor N	Ground
24 V AC/DC	L+	N-	PE
	Phase L or +	Zero conductor N or -	Ground

Relay (power unit, slot 6)

Type	Terminal (max. 250 V, 3 A)				
Alarm relay 1	R11	R12	R13		
	Changeover contact	Normally closed contact (NC) <sup>1)</sup>	Normally open contact (NO) <sup>2)</sup>		
Relay 2 to 6				Rx1	Rx2
				Switching contact	Normally open contact (NO) <sup>2)</sup>

- 1) NC = normally closed (breaker)
- 2) NO = normally open (maker)

**i** The open or close function (= activation or deactivation of the relay coil) in a limit event can be configured in the setup: "Setup -> Advanced setup -> Outputs -> Relay -> Relay x". However, in the event of a power failure, the relay adopts its quiescent switch state regardless of the setting programmed.

Digital inputs; auxiliary voltage output (power unit, slot 6)

Type	Terminal			
Digital input 1 to 6	D11 to D61	GND1		
	Digital input 1 to 6 (+)	Ground (-) for digital inputs 1 to 6		

Type	Terminal			
Auxiliary voltage output, not stabilized, max. 250 mA			24V Out -	24V Out +
			- Ground	+ 24V (±15%)

**i** If the auxiliary voltage is to be used for the digital inputs, the **24 V out -** terminal of the auxiliary voltage output must be connected with the **GND1** terminal.

**Analog inputs (slot 1-5)**

The first digit (x) of the two-digit terminal number corresponds to the associated channel:

Type	Terminal					
	x1	x2	x3	x4	x5	x6
Current/pulse/frequency input <sup>1)</sup>					(+)	(-)
Voltage > 1V		(+)				(-)
Voltage ≤ 1V				(+)		(-)
Resistance thermometer RTD (2-wire)	(A)					(B)
Resistance thermometer RTD (3-wire)	(A)			b (sense)		(B)
Resistance thermometer RTD (4-wire)	(A)		a (sense)	b (sense)		(B)
Thermocouples TC				(+)		(-)

1) If a universal input is used as a frequency or pulse input, a series resistor must be used in series connection with the voltage source. Example: 1.2 kΩ series resistor at 24 V

### HART® inputs (slot 1-5)

The first digit (x) of the two-digit terminal number corresponds to the associated channel:

Type	Terminal					
	x1	x2	x3	x4	x5	x6
HART® (4 to 20 mA)	SHD	H_1	H_2	R <sub>com</sub>	I+	I-

- i** A 250 Ω communication resistor (load) is installed on the device side between terminals x4 and x5.
- A 10 Ω resistor (shunt) is installed on the device side at the current input between terminals x5 and x6.
- Terminals x2 and x3 (H\_1 and H\_2) are jumpered internally.
- The internal HART® modem is located between terminals x2/x3 and x6.

### Relay extension (digital card, slot 5)

Type	Terminal (max. 250 V, 3 A)			
Relay 7, 8	RA	RB	RC	RD
Relay 9, 10	RE	RF	RG	RH
Relay 11, 12	RI	RJ	RK	RL
	Switching contact	Normally open contact (1)	Switching contact	Normally open contact (2)

- 1) NO)
- 2) NO)

- i** The open or close function (= activation or deactivation of the relay coil) in a limit event can be configured in the setup: "Setup -> Advanced setup -> Outputs -> Relay -> Relay x". However, in the event of a power failure, the relay adopts its quiescent switch state regardless of the setting programmed.

### Analog outputs (digital card, slot 5)

Type	Terminal			
Analog output 1-2	O15	O16	O25	O26
	Analog output 1 (+)	Ground, analog output 1 (-)	Analog output 2 (+)	Ground, analog output 2 (-)

**Extension of digital inputs (digital card, slot 5)**

Type	Terminal		
Digital input 7 to 14	D71 to DE1	GND2	GND2
	Digital input 7 to 14 (+)	Ground (-) for digital inputs 7 to 14	Ground (-) for digital inputs 7 to 14

**i** If the auxiliary voltage is to be used for the digital inputs, the **24 V out** - terminal of the auxiliary voltage output (power unit, slot 6) must be connected with the **GND2** terminal.

Device plug 

- Panel-mounted device/DIN rail version: connected to mains via plug-in screw terminals with reverse polarity protection
- Desktop version (option): connected to mains via IEC connector

Overvoltage protection To avoid high-energy transients on long signal cables, connect a suitable surge arrester upstream (e.g. E+H HAW562) in series upstream.

Connection data interface, communication 
**USB interfaces:**  
*1 x USB port type A (host) on the front of device (only for version with navigator and front interfaces)*  
 A USB 2.0 port is available on a shielded USB A socket at the front of the device. A USB stick as a memory medium, for example, can be connected to this port. An external keyboard/mouse for device operation, a USB hub, a barcode reader or a printer (PCL5c or higher) may also be connected.  
  
*1 x USB port type B (function) on the front of device (only for version with navigator and front interfaces)*  
 A USB 2.0 port is available on a shielded USB B socket at the front of the device. This can be used to connect the device for communication with a laptop, for example.  
  
*2 x USB port type A (host) on the rear of the device (standard)*  
 Two USB 2.0 ports are available on shielded USB A sockets at the rear of the device. A USB stick as a memory medium, for example, can be connected to these ports. An external keyboard/mouse for device operation, a USB hub, a barcode reader or a printer (PCL5c or higher) may also be connected.  
  
**i**

- USB-2.0 is compatible with USB-1.1 or USB-3.0, i.e. communication is possible.
- The assignment of the USB interfaces complies with the standard such that shielded standard cables with a maximum length of 3 meters (9.8 ft) can be used here.
- The USB devices are detected by the "plug-and-play" function. If several devices of the same type are connected, only the USB device that was connected first is available.
- A maximum of 8 external USB devices (incl. USB hub) can be connected if they do not exceed the maximum load of 500 mA. If overloaded, the corresponding USB devices are automatically disabled. An active USB hub can be used for higher power ratings.

**Reference list for USB printers:**

HP Color LaserJet CP1515n, HP Color LaserJet Pro CP1525n, ECOSYS P6021cdn.



The printer must support PCL5c (or higher). GDI printers are not supported!

**Reference list for USB barcode readers:**

Datalogic Gryphon D230; Metrologic MS5100 Eclipse Series; Symbol LS2208, Datalogic Quickscan 1, Godex GS220, Honeywell Voyager 9590.

**Ethernet interface (standard):**

Ethernet interface on back, 10/100 Base-T, plug type RJ45. The Ethernet interface can be used to integrate the device via a hub or switch into a PC network (TCP/IP Ethernet). A standard patch cable (e.g. CAT5E) can be used for the connection. Using DHCP, the device can be fully integrated into an existing network without the need for additional configuration. The device can be accessed from every PC in the network. Normally only the automatic assignment of the IP address must be configured at the client. When the device is started, it can automatically retrieve the IP address, subnet mask and gateway from a DHCP server. If a DHCP is not used, these settings must be made directly in the device (depends on the specific network). Two Ethernet function LEDs are located on the rear of the device.

The following functions are implemented:

- Data communication with PC software (analysis software, configuration software, OPC server)
- Web server
- WebDAV (Web-based Distributed Authoring and Versioning) is an open standard for the provisioning of files via the HTTP protocol. The data saved on the device's SD card can be read out using a PC. A Web browser or a WebDAV client can be selected as the network drive for this on the PC side.

*Requirements with regard to a network printer:*

**Network printer reference list:**

HP Color LaserJet CP1515n, HP Color LaserJet Pro CP1525n, ECOSYS P6021cdn.



The printer must support PCL5c (or higher). GDI printers are not supported!

**Ethernet Modbus TCP master (option):**

As a Modbus master, the device can interrogate other Modbus slaves via Ethernet. The Modbus TCP master can be operated in parallel with the Profibus DP slave, Modbus RTU/TCP slave or PROFINET I/O Device.

Up to 40 analog inputs can be transmitted via Modbus and stored in the device.

**Ethernet Modbus TCP slave (option):**

Connection to SCADA systems (Modbus master).

Up to 40 analog inputs and 20 (14 real + 6 virtual) digital inputs can be transmitted via Modbus and stored in the device.

**Serial RS232/RS485 interface:**

A combined RS232/RS485 connection is available on a shielded SUB D9 socket at the rear of the device. This can be used for data transfer and to connect a modem. For communication via modem, we recommend an industrial modem with a watchdog function.

- The following baud rates are supported: 9600, 19200, 38400, 57600, 115200
- Max. cable length with a shielded cable: 2 m (6.6 ft) (RS232), or 1000 m (3281 ft) (RS485)

 Only one interface can be used at any one time (RS232 or RS485).

*Modbus RTU master (option):*

As a Modbus master, the device can interrogate other Modbus slaves via RS485. The Modbus RTU master can be operated in parallel with the Profibus-DP slave, PROFINET I/O Device or Modbus TCP slave.

Up to 40 analog inputs can be transmitted via Modbus and stored in the device.

*Modbus RTU slave (option):*

The device can be interrogated as a Modbus slave by another Modbus master via RS485.

Up to 40 analog inputs and 20 (14 real + 6 virtual) digital inputs can be transmitted via Modbus and stored in the device.

 A Modbus RTU master and RTU slave cannot be operated in parallel.

*Remote interrogation with analog or GSM/GPRS wireless modem:*

**Analog modem:**

An analog modem for industrial use (e.g. Devolo or WESTERMO), which is connected to the RS232 interface with a special modem cable (see accessories →  97), is recommended.

**GSM/GPRS wireless modem:**

A GSM/GPRS wireless modem for industrial use (e.g. Cinterion, INSYS or WESTERMO, incl. antenna and power unit), which is connected to the RS232 interface with a special modem cable (see accessories →  97), is recommended.

Important: the wireless modem needs a SIM card and data transfer subscription. In addition, it must be possible to deactivate the PIN prompt.

 If the Web server is operated via a wireless modem, this may result in high provider costs as data are transmitted continuously.

**AnyBus® interface (CPU card, slot 0, optional)**

*PROFIBUS-DP slave:*

The device can be integrated into a fieldbus system as per the PROFIBUS-DP standard by means of the PROFIBUS-DP interface. Up to 40 analog inputs and 20 (14 real + 6 virtual) digital inputs can be transmitted via PROFIBUS-DP and stored in the device. Bidirectional communication with cyclic data transfer is possible. Connection via Sub-D socket.

Baud rate: maximum 12 Mbit/s

*EtherNet/IP adapter (slave):*

Up to 40 analog inputs and 20 (14 real + 6 virtual) digital inputs can be transmitted via EtherNet/IP and stored in the device. The built-in module corresponds to I/O server category (Level 2). It has an integrated 2-port switch, thereby supporting EtherNet/IP communication in line or ring topologies. Connection via 2 RJ45 standard sockets.

*PROFINET I/O device:*

Up to 40 analog inputs and 20 (14 real + 6 virtual) digital inputs can be transmitted via PROFINET IO and stored in the device. The 2-port module for PROFINET IO meets compliance class B. The integrated switch enables communication in line or ring topologies without an additional external switch. Connection via 2 RJ45 standard sockets.

## 16.5 Performance characteristics

Response time	Input	Output	Time [ms]
	Current, voltage, pulse	Relays, OC, analog output	≤ 550
	RTD	Relays, OC, analog output	≤ 1150
	TC <sup>1)</sup>	Relays, OC, analog output	≤ 1550
	Cable open circuit detection, current input	Relays, OC, analog output	≤ 1150
	Sensor error RTD, TC	Relays, OC, analog output	≤ 5000
	Digital input	Relays, OC, analog output	≤ 350
	HART® input	Relays, OC, analog output	Non-deterministic

1) If internal measuring point temperature compensation is used, otherwise values as for voltage

Reference operating conditions	<b>Reference temperature</b>	25 °C (77 °F) ±5 K
	<b>Warm-up period</b>	120 min.
	<b>Humidity</b>	20 to 60 % rel. humidity

Hysteresis Can be configured for limit values in the setup

Long-term drift As per IEC 61298-2: max. ±0.1%/year (of measuring range)

## 16.6 Mounting

Panel mounting: mounting location and installation dimensions

The device with a display is designed for use in a panel.

 The device must be installed in a pressurized enclosure system for operation in the hazardous area. To ensure safe installation, it is essential to follow the installation instructions for the cabinet and the installation instructions in the Ex-related Safety Instructions (XA).

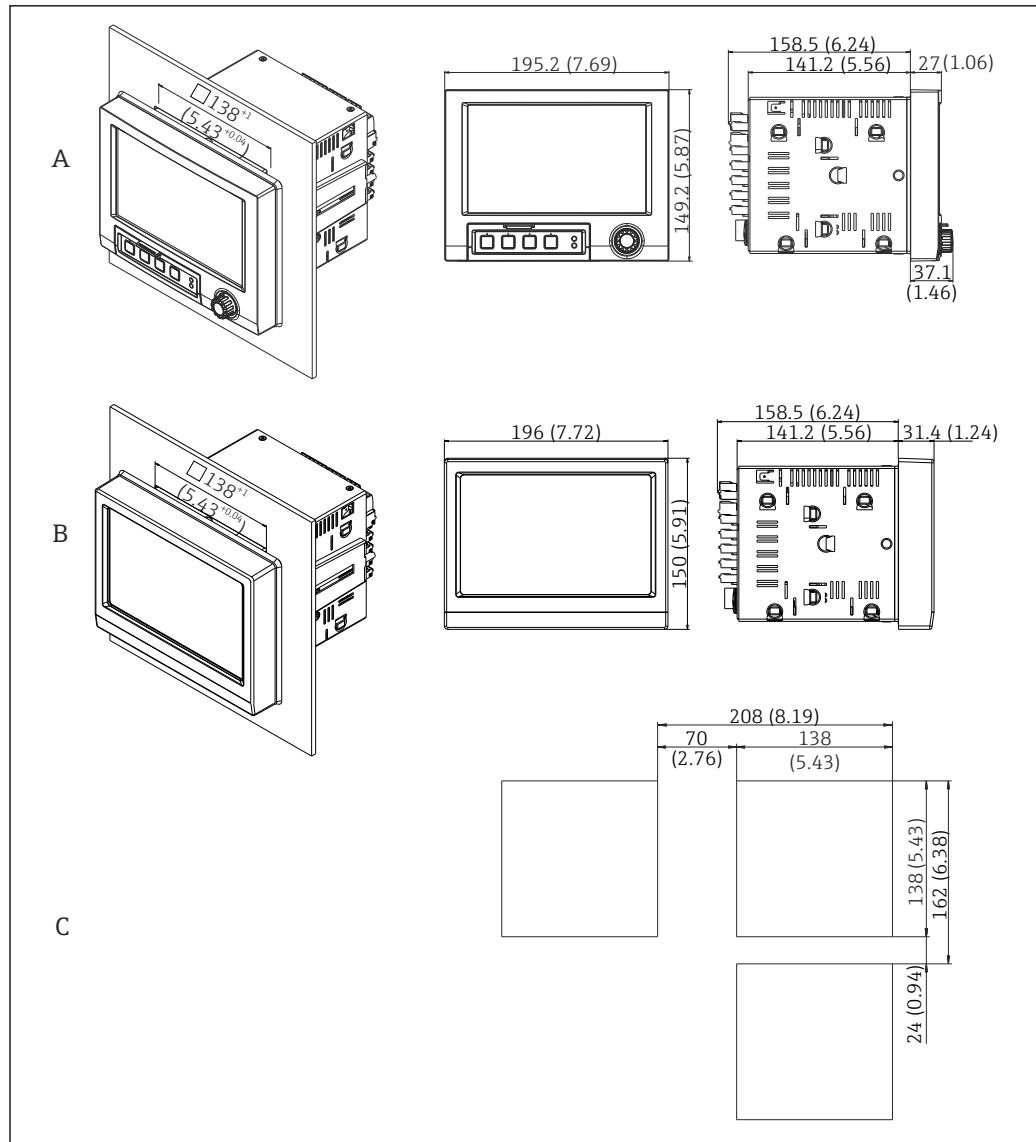

A0024610

23 Panel mounting and dimensions in mm (in).

- A Version with navigator and front interfaces
- B Version with stainless steel front and touchscreen
- C Grid dimensions of panel cutouts for multiple devices

### Dimensions

- Installation depth (excluding terminal cover): approx. 159 mm (6.26 in) for device incl. terminals and fastening clips.
- Installation depth including terminal cover (option): approx. 198 mm (7.8 in)
- Panel cutout: 138 to 139 mm (5.43 to 5.47 in) x 138 to 139 mm (5.43 to 5.47 in)
- Panel thickness: 2 to 40 mm (0.08 to 1.58 in)
- viewing angle range: 50° in all directions from the display central axis
- A minimum distance of 12 mm (0.47 in) between the devices must be observed if aligning the devices vertically above one another or horizontally beside one another.
- The grid dimension of the panel cutouts for multiple devices must be at least 208 mm (8.19 in) horizontally and at least 162 mm (6.38 in) vertically (tolerance not considered).
- Securing to DIN 43 834



Mounting location and installation dimensions for the DIN rail version

The device without a display is designed for DIN rail mounting.

 The DIN rail device is **not** approved for operation in the hazardous area.

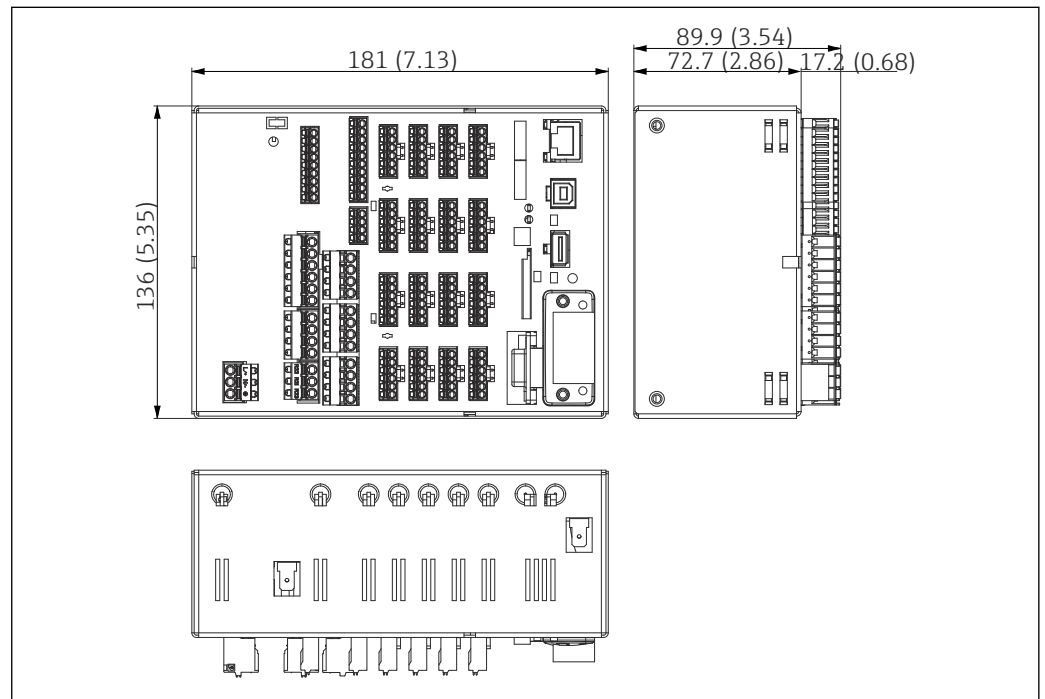

A0036528

 24 DIN rail version, dimensions in mm (in).

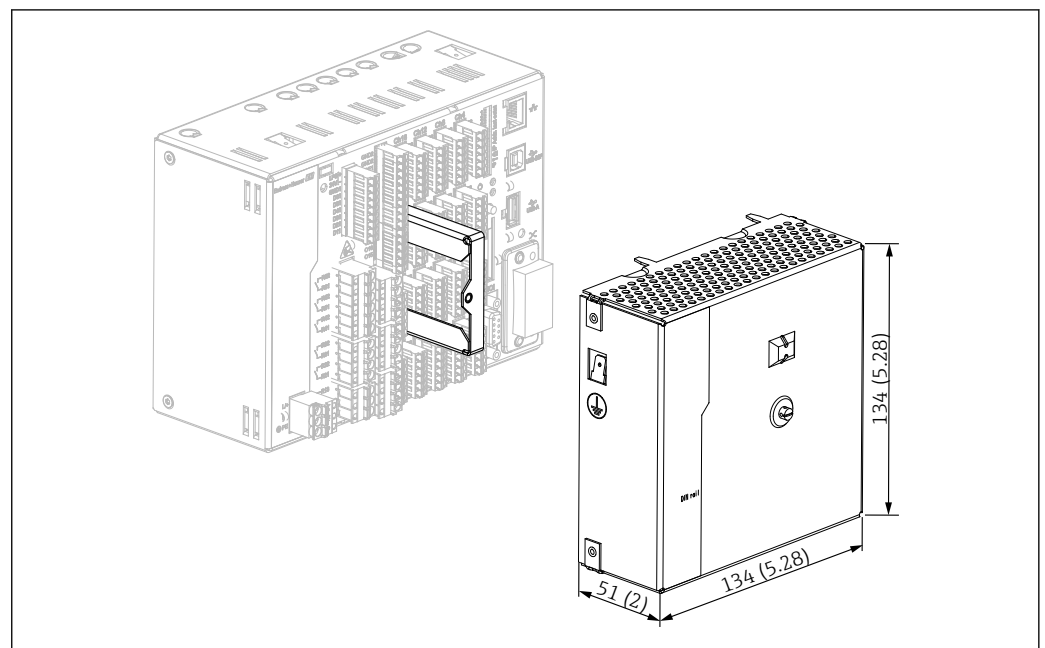

A0046633

 25 Terminal cover, DIN rail version, dimensions in mm (in)

### Dimensions

- Installation depth: approx. 90 mm (3.54 in) for device incl. terminals (w/o terminal cover).
- Mounted on DIN rail as per IEC 60715
- The devices can be arranged horizontally beside one another without clearance between the devices.

Field housing assembly and design (optional) As an option, the panel-mounted device can be ordered ready-mounted in a field housing with IP65.  
Dimensions (B x H x D) approx.: 320 mm (12.6 in) x 320 mm (12.6 in) x 254 mm (10 in)

Desktop housing assembly and design (optional) As an option, the panel-mounted device can be ordered ready-mounted in a desktop housing.  
Dimensions (B x H x D) approx.: 293 mm (11.5 in) x 188 mm (7.4 in) x 213 mm (8.39 in) (dimensions with bracket, feet and installed device)

## 16.7 Environment

Ambient temperature range -10 to +50 °C (14 to 122 °F)

Storage temperature -20 to +60 °C (-4 to +140 °F)

Humidity 5 to 85 %, non-condensing

Climate class To IEC 60654-1: Class B2

Electrical safety Class I equipment, overvoltage category II  
Pollution level 2

Operating altitude < 2 000 m (6 561 ft) above MSL

Degree of protection	<b>Front of panel-mounted device</b>	IP65 / NEMA 4 (UL50 type 4)
	<b>Back of panel-mounted device (terminal side)</b>	IP20
	<b>DIN rail version</b>	IP20 (overall device)

Electromagnetic compatibility EMC in accordance with all relevant requirements of the IEC/EN 61326 series and NAMUR NE21. For details, refer to the Declaration of Conformity.

- Interference immunity: as per IEC/EN 61326 series (industrial environment) / NAMUR NE21  
Maximum measured error <1% of measuring range
- Interference emissions: as per IEC 61326-1 Class A

## 16.8 Mechanical construction

Design, dimensions Information about design and dimensions →  119

Weight

- Panel-mounted device with navigator and front interfaces (with maximum configuration): approx. 2.7 kg (5.9 lbs)
- Panel-mounted device with stainless steel front and touchscreen (with maximum configuration): approx. 3.2 kg (7 lbs)
- DIN rail version: approx. 1.8 kg (3.97 lbs)
- Desktop housing (excluding device): approx. 2.3 kg (5 lbs)
- Field housing (excluding device): approx. 4 kg (8.8 lbs)

Materials

<b>Panel-mounted device with navigator and front interfaces</b>	
Front frame	Zinc die cast GD-Z410, powder-coated
Display glass	Transparent Makrolon® plastic (FR clear 099) UL94-V2
Flap; jog/shuttle dial ("Navigator")	Plastic ABS UL94-V2
Membrane keypad	Polyester membrane PC-ABS UL94-V2
Intermediate frame (front towards control panel)	Plastic PA6-GF20 UL94-V2
Seal towards panel wall; seal in flap; seal towards navigator	Rubber EPDM 70 Shore A
Casing; rear panel	Galvanized sheet steel St 12 ZE

<b>Panel-mounted device with stainless steel front and touchscreen</b>	
Front frame	AISI 316L
Display glass	6 mm single-pane safety glass (soda-lime glass)
Intermediate frame (front towards control panel)	Plastic PA6-GF20 UL94-V2
Seal towards control panel wall	Rubber EPDM 70 Shore A
Window seal between front frame and glass	Rubber EPDM 60 Shore A
Casing; rear panel	Galvanized sheet steel St 12 ZE

<b>DIN rail version</b>	
Retaining bracket	EN AW 6060 T66 / AlMgSi0.5 F22
Casing; front	Galvanized sheet steel St 12 ZE

Designation	Short form	Properties
AISI 316L (corresponds to 1.4404 or 1.4435)	X2CrNiMo17-13-2, X2CrNiMo18-14-3	Austenitic, stainless steel High corrosion resistance in general

 All materials are silicone-free.

**Materials of desktop housing**

- Housing half-panels: sheet steel, electrolytically plated (powder-coated)
- Side sections: aluminum extruded section (powder-coated)
- Section ends: colored polyamide
- Feet: colored polyamide, fiber-glass reinforced

**Field housing materials**

- Housing (front frame, door, base frame, side parts): thermoplastic polycarbonate PC
- Front panel and wall mounting: chrome-nickel stainless steel 1.4301 V2A

## 16.9 Display and operating elements

### Operating concept

 The description for local operation does not apply for the DIN rail version, as this has neither a display screen nor operating elements. The description for remote configuration applies for all versions.

The device can be operated directly onsite, or via remote configuration with the PC via interfaces and operating tools (Web server, configuration software).

#### Web server

A Web server is integrated into the device. The Web server offers the following range of functions:

- Easy configuration without additional installed software
- Instantaneous value display and diagnostics information
- Display of current measured value curves via Web browser (remote control)
- Display of historical measured data in numerical format or as a curve
- Display of events and logbook entries
- Loading/saving of device configuration
- Device firmware update
- Printout of device configuration

#### Integrated operating instructions

The device's simple operating concept enables you to perform commissioning for many applications without the need for hardcopy operating instructions. The device has an integrated help function and displays operating instructions directly on screen.

### Local operation

#### Display elements on panel-mounted device

##### Type

Wide-screen TFT color graphic display (optionally with touch control)

##### Size (diagonal screen measurement)

178 mm (7")

##### Resolution

Wide VGA 384,000 pixels (800 x 480 pixels)

##### Backlight

50,000 h half value time (= half brightness)

##### Number of colors

262,000 viewable colors, 256 colors used

##### Viewing angle

Max. viewing angle range: 50° in all directions from the display central axis

##### Screen display

- Users can choose between black or white for the background color
- Active channels can be assigned to up to 10 groups. These groups can be given a name e.g. "Temp. boiler 1" or "Daily averages" so that they can be uniquely identified.
- Scales linear or logarithmic
- Measured value history: quick retrieval of historic data with zoom function
- Pre-formatted display formats, such as horizontal or vertical curves, instrument display, circular chart, process screen, bargraph or digital display.

Measured value display and operating elements

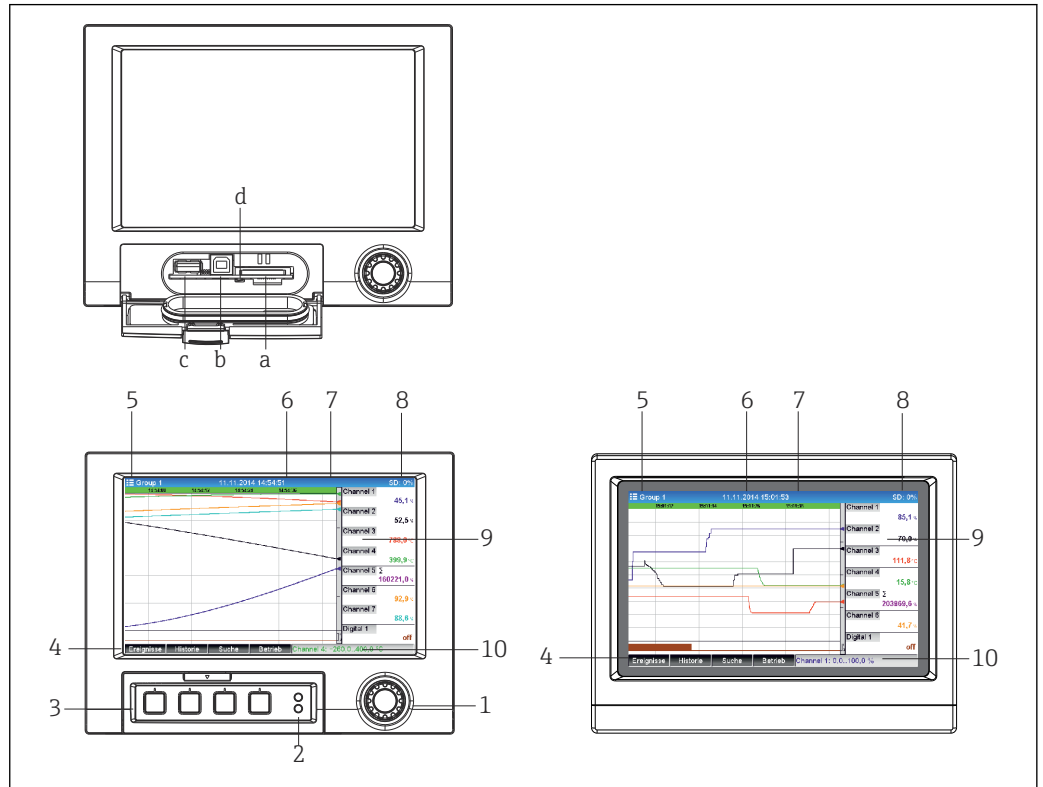

A0024709

26 Device front (left: version with navigator and front interfaces; right: version with stainless steel front and touchscreen)

Item No.	Operating function (display mode = display of measured values) (Setup mode = operation in the Setup menu)
a	Slot for SD card
b	USB B socket "Function" e.g. to connect to PC or laptop
c	USB A socket "Host" e.g. for USB memory stick, external keyboard, barcode reader or printer
d	LED at SD slot. Yellow LED lit or flashing when the device writes to the SD card or reads it. <b>Do not remove the SD card if the LED is lit or flashing! Risk of data loss!</b>
1	"Navigator": jog/shuttle dial for operating with additional press/hold function. In display mode: turn the dial to switch between the various signal groups. Press the dial to display the main menu. In setup mode or in a selection menu: turn the dial anticlockwise to move the bar or the cursor upwards or to the left, changes the parameter. Turning clockwise moves the bar or cursor down or to the right, changes the parameter. Press = select highlighted function, start parameter change (ENTER key).
2	Functions of LED indicators (according to NAMUR NE44:): <ul style="list-style-type: none"> <li>Green LED (top) lit: power supply OK</li> <li>Red LED (bottom) flashing: maintenance required, caused by external factor (e.g. cable open circuit etc.) or a message/notification requiring acknowledgment is pending, calibration is running.</li> </ul>
3	Variable "soft keys" 1-4 (from left to right)
4	Function indicator of "soft keys"
5	In display mode: current group name, type of analysis; In setup mode: name of the current operating item (dialog title)
6	In display mode: displays current date/time In setup mode: --

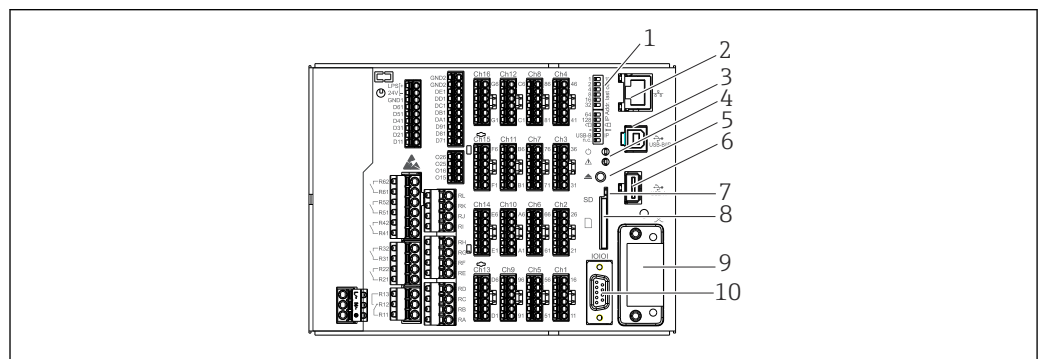

Item No.	Operating function (display mode = display of measured values) (Setup mode = operation in the Setup menu)
7	In display mode: user ID (if function is active) In setup mode: --
8	In display mode: alternating display indicating the percentage space on the SD card or USB stick that has already been used. Status symbols are also displayed in alternation with the memory information (e.g. simulation mode, data storage active, operation lock, batch active) In setup mode: the current "direct access" operating code is displayed
9	In display mode: window for measured value display (e.g. curve display). Display of current measured values and the status in the event of an error/alarm condition. In the case of counters, the type of counter is displayed as a symbol.  If a measuring point has limit value status, the corresponding channel identifier is highlighted in red (quick detection of limit value violations). During a limit value violation and device operation, the acquisition of measured values continues uninterrupted.
9	In setup mode: display of operating menu
10	In display mode: alternating status display (e.g. set zoom range) of the analog or digital inputs in the appropriate color of the channel. In setup mode: different information is displayed here depending on the display type.

**Operating elements of the DIN rail version**





A0036811

 27 Device front of the DIN rail version

Item No.	Operating function																																																				
1	<p><b>DIP switches</b></p> <p>The behavior of the Ethernet interface is configured via DIP switches (left = OFF, right = ON). For a detailed description of the DIP switch functions →  50</p> <p>Function of the DIP switches (1 = top, 12 = bottom):</p> <ul style="list-style-type: none"> <li>■ DIP switches 1-8: configuration of IP address in last octet (e.g. 192.168.1.<b>212</b>)</li> <li>■ DIP switch 9: OFF = setup change not locked ON = setup locked</li> <li>■ DIP switch 10: OFF = default / OFF ON = service addressing</li> <li>■ DIP switch 11 for the configuration of the USB-B interface: OFF = USB standard ON = Ethernet via USB (Web server)</li> <li>■ DIP switch 12: not assigned</li> </ul> <p> The DIN rail version is supplied with the following Ethernet settings: IP address: 192.168.1.212; subnet mask: 255.255.255.0; gateway: 0.0.0.0</p> <div style="text-align: right;"> <table border="0"> <tr> <td></td> <td>OFF</td> <td>ON</td> <td></td> </tr> <tr> <td>IP Addr. last octet</td> <td>1</td> <td><input type="checkbox"/></td> <td>1</td> </tr> <tr> <td></td> <td>2</td> <td><input type="checkbox"/></td> <td>2</td> </tr> <tr> <td></td> <td>3</td> <td><input type="checkbox"/></td> <td>3</td> </tr> <tr> <td></td> <td>4</td> <td><input type="checkbox"/></td> <td>4</td> </tr> <tr> <td></td> <td>5</td> <td><input type="checkbox"/></td> <td>5</td> </tr> <tr> <td></td> <td>6</td> <td><input type="checkbox"/></td> <td>6</td> </tr> <tr> <td></td> <td>7</td> <td><input type="checkbox"/></td> <td>7</td> </tr> <tr> <td></td> <td>8</td> <td><input type="checkbox"/></td> <td>8</td> </tr> <tr> <td></td> <td>9</td> <td><input type="checkbox"/></td> <td>9</td> </tr> <tr> <td></td> <td>10</td> <td><input type="checkbox"/></td> <td>10</td> </tr> <tr> <td>USB-B</td> <td><input type="checkbox"/></td> <td><input type="checkbox"/></td> <td>11</td> </tr> <tr> <td>n.c.</td> <td><input type="checkbox"/></td> <td><input type="checkbox"/></td> <td>12</td> </tr> </table> </div>		OFF	ON		IP Addr. last octet	1	<input type="checkbox"/>	1		2	<input type="checkbox"/>	2		3	<input type="checkbox"/>	3		4	<input type="checkbox"/>	4		5	<input type="checkbox"/>	5		6	<input type="checkbox"/>	6		7	<input type="checkbox"/>	7		8	<input type="checkbox"/>	8		9	<input type="checkbox"/>	9		10	<input type="checkbox"/>	10	USB-B	<input type="checkbox"/>	<input type="checkbox"/>	11	n.c.	<input type="checkbox"/>	<input type="checkbox"/>	12
	OFF	ON																																																			
IP Addr. last octet	1	<input type="checkbox"/>	1																																																		
	2	<input type="checkbox"/>	2																																																		
	3	<input type="checkbox"/>	3																																																		
	4	<input type="checkbox"/>	4																																																		
	5	<input type="checkbox"/>	5																																																		
	6	<input type="checkbox"/>	6																																																		
	7	<input type="checkbox"/>	7																																																		
	8	<input type="checkbox"/>	8																																																		
	9	<input type="checkbox"/>	9																																																		
	10	<input type="checkbox"/>	10																																																		
USB-B	<input type="checkbox"/>	<input type="checkbox"/>	11																																																		
n.c.	<input type="checkbox"/>	<input type="checkbox"/>	12																																																		
2	Ethernet interface																																																				

A0036815

Item No.	Operating function
3	USB B socket "Function" e.g. to connect to PC or laptop
4	<p>Functions of LED indicators (according to NAMUR NE44:)</p> <ul style="list-style-type: none"> <li>■ Green LED (top) lit: power supply OK</li> <li>■ Red LED (bottom) flashing: maintenance required, caused by external factor (e.g. cable open circuit etc.) or a message/notification requiring acknowledgment is pending, calibration is running.</li> </ul>
5	<p>Cyclic storage is completed via the "Remove SD card safely" button, the LED (d) goes out. The SD card can now be removed.</p> <p> If the SD card is not removed within 5 minutes, the write cycles start again.</p>
6	<p>USB A socket "Host" e.g. for USB memory stick or printer</p> <p>If a USB stick is inserted, data that have not yet been saved are copied to the stick automatically. The red LED on the USB socket flashes while the data are being copied to the stick.</p> <p> <b>Do not remove the USB stick when the red LED is flashing! Risk of data loss!</b></p> <p>If an error occurs (e.g. USB stick full or defective), the red LED is lit constantly. Remove the USB stick and replace it.</p>
7	<p>LED at SD slot. Yellow LED lit or flashing when the device writes to the SD card or reads it.</p> <p> <b>Do not remove the SD card if the LED is lit or flashing! Risk of data loss!</b></p>
8	Slot for SD card
9	Anybus® interface (option)
10	Serial RS232/RS485 interface

## Languages

The following languages can be selected in the operating menu: German, English, Spanish, French, Italian, Dutch, Swedish, Polish, Portuguese, Czech, Russian, Japanese, Chinese (Traditional), Chinese (Simplified)



## Remote operation

### Device access via operating tools

Device configuration and measured value retrieval can also be done via interfaces. The following operating tools are available for this purpose:

Operating tool	Functions	Access via
"Field Data Manager (FDM)" analysis software, SQL database support (included in the delivery)	<ul style="list-style-type: none"> <li>■ Export of saved data (measured values, analyses, event log)</li> <li>■ Visualization and processing of saved data (measured values, analyses, event log)</li> <li>■ Safe archiving of exported data in a SQL database</li> </ul>	RS232/RS485, USB, Ethernet
Web server (integrated into the device; access via browser)	<ul style="list-style-type: none"> <li>■ Display of current and historical data and measured value curves via the Web browser</li> <li>■ Easy configuration without additional installed software</li> <li>■ Remote access to device and diagnostic information</li> </ul>	Ethernet, or Ethernet via USB
OPC server (optional)	<p>The following momentary values can be provided:</p> <ul style="list-style-type: none"> <li>■ Analog channels</li> <li>■ Digital channels</li> <li>■ Mathematics</li> <li>■ Totalizer</li> </ul>	RS232/RS485, USB, Ethernet
"FieldCare / DeviceCare" configuration software	<ul style="list-style-type: none"> <li>■ Device configuration</li> <li>■ Loading and saving of device configurations (upload/download)</li> <li>■ Documentation of the measuring point</li> </ul>	USB, Ethernet

## 16.10 Certificates and approvals

-  For certificates and approvals valid for the device: see the data on the nameplate
-  Approval-related data and documents: [www.endress.com/deviceviewer](http://www.endress.com/deviceviewer) → (enter the serial number)

---

CE mark	The product meets the requirements of the harmonized European standards. As such, it complies with the legal specifications of the EC directives. The manufacturer confirms successful testing of the product by affixing to it the CE-mark.
---------	--

---

Electronic recording/ electronic signature	FDA 21 CFR Part 11 The device meets the requirements of the "Food and Drug Administration" for electronic recording/electronic signature.
---	--

---

Certifications	<ul style="list-style-type: none"> <li>■ HART® certification (HCF)</li> <li>■ PROFINET certification</li> <li>■ EtherNet/IP certification</li> </ul>
----------------	--

---

Other standards and guidelines	<ul style="list-style-type: none"> <li>■ IEC 60529: Degrees of protection provided by enclosures (IP code)</li> <li>■ IEC/EN 61010-1: Safety requirements for electrical equipment for measurement, control, and laboratory use</li> <li>■ IEC/EN 61326 series: Electromagnetic compatibility (EMC requirements)</li> </ul>
-----------------------------------	---

## 16.11 Ordering information

-  The hazardous area version (Ex version) is only available in conjunction with the stainless steel front and touch control.

---

Ordering information	Detailed ordering information is available for your nearest sales organization <a href="http://www.addresses.endress.com">www.addresses.endress.com</a> or in the Product Configurator under <a href="http://www.endress.com">www.endress.com</a> :
----------------------	---

1. Click Corporate
2. Select the country
3. Click Products
4. Select the product using the filters and search field
5. Open the product page

The Configuration button to the right of the product image opens the Product Configurator.

-  **Product Configurator - the tool for individual product configuration**
  - Up-to-the-minute configuration data
  - Depending on the device: Direct input of measuring point-specific information such as measuring range or operating language
  - Automatic verification of exclusion criteria
  - Automatic creation of the order code and its breakdown in PDF or Excel output format
  - Ability to order directly in the Endress+Hauser Online Shop



## Scope of delivery

The scope of delivery of the device comprises:

- Device (with terminals, as per order)
- Panel-mounted device: 2 screw fastening clips
- Version with navigator and front interfaces or DIN rail version: USB cable
- Panel-mounted device: sealing rubber towards the panel wall
- "Industrial Grade" SD card, industry standard:  
Panel-mounted device with navigator and front interfaces: card is located in the SD slot behind the flap on the front of the device (optional).  
Panel-mounted device with stainless steel front and touchscreen: card is located in the device and cannot be replaced or retrofitted.  
DIN rail version: card is located in the SD slot (optional).
- "Field Data Manager (FDM)" analysis software on DVD (Essential, Demo or Professional version, depending on order)
- Delivery note
- Multilanguage Brief Operating Instructions, hard copy
- Ex Safety Instructions, hard copy (optional)

## 16.12 Supplementary documentation

### Standard documentation

- Technical Information for Memograph M RSG45: TI01180R
- Operating Instructions for Memograph M RSG45: BA01338R
- Brief Operating Instructions for Memograph M RSG45: KA01177R
- System components and data manager - solutions to complete your measuring point: FA00016K

### Supplementary device-dependent documentation

- Competence brochure PROFIBUS® - process automation with digital fieldbus technology: CP00005S
- Operating Instructions for Memograph M RSG45 with telealarm: BA01387R
- Operating Instructions for Memograph M RSG45 with Modbus RTU / TCP slave: BA01388R
- Operating Instructions for Memograph M RSG45 with Modbus RTU / TCP master: BA01390R
- Operating Instructions for Memograph M RSG45 with wastewater + RSB (rain spillway basin) option: BA01337R
- Operating Instructions for Memograph M RSG45 with batch software: BA01411R
- Operating Instructions for Memograph M RSG45 with energy option: BA01412R
- Operating Instructions for Memograph M RSG45 with EtherNet/IP® adapter: BA01413R
- Operating Instructions for Memograph M RSG45 with PROFIBUS® DP slave: BA01414R
- Operating Instructions for Memograph M RSG45 with PROFINET: BA01415R
- Operating Instructions for Memograph M RSG45 with TrustSens Calibration Monitoring: BA01887R
- Ex-related additional documentation:  
ATEX II2G Ex px IIC T4 Gb, ATEX II2D Ex pD IIIC T135°C Db: XA01362R

## 17 Appendix

### 17.1 Operating items in the "Expert" menu

The parameter groups for the Expert setup contain all the parameters of the operating menus: System, Input and Output Setup, Communication, Application, Diagnostics as well as other parameters that are reserved for experts only.

 For most settings, the "Setup" or "Expert" menu must be quit before the settings are adopted. However settings such as the date/time are accepted immediately.

 **Information on configuration using FieldCare/DeviceCare configuration software**

- Offline configuration: Most of the parameters are available (depending on the device configuration).
- Online configuration: Only parameters labeled "Online configuration" are available.

---

#### Direct access

---

<b>Navigation</b>	 Expert → Direct access
<b>Description</b>	Direct access to active operating items (rapid access). Entering the direct access code takes you directly to the desired operating parameter. The direct access code is displayed in the Setup menu on the top right of the display (e.g. 00000-000).
<b>Text entry</b>	(e.g. 00000-000)

#### 17.1.1 "System" submenu

Basic settings that are needed to operate the device (e.g. date, time, etc.)

---

#### Language

---

<b>Navigation</b>	 Expert → System → Language Direct access code: 010000-000
<b>Description</b>	Select the operating language of the device.
<b>Selection</b>	German, English, Spanish, French, Italian, Dutch, Polish, Portuguese, Russian, Swedish, Czech, Japanese, Chinese (Simplified), Chinese (Traditional)
<b>Factory setting</b>	English; or preset to customer's preferred language

---

#### Device tag

---

<b>Navigation</b>	 Expert → System → Device tag Direct access code: 000031-000
<b>Description</b>	Individual device tag

**User entry** Text entry (max. 32 characters)

**Factory setting** Unit 1

---

### Temp. unit

---

**Navigation**  Expert → System → Temp. unit  
Direct access code: 100001-000

**Description** Selection of temperature unit. All directly connected thermocouples or resistance thermometers (RTD) are displayed in the preset engineering units.

**Selection** °C, °F, K

**Factory setting** °C

---

### Decimal separator

---

**Navigation**  Expert → System → Decimal separator  
Direct access code: 100003-000

**Description** Select in which form the decimal separator character is to be displayed.

**Selection** Comma, point

**Factory setting** Comma

---

### Fault switching

---

**Navigation**  Expert → System → Fault switching  
Direct access code: 100002-000

**Description** If the device detects a system error (e.g. hardware defect) or a fault (e.g. cable open circuit), the selected output switches.

**Selection** Not used, Relay x  
All the available relays are displayed.

**Factory setting** Relay 1

---

### Keyboard layout

 This function is **not** supported by the **DIN rail version**.

---

---

<b>Navigation</b>	 Expert → System → Keyboard layout Direct access code: 100020/000
<b>Description</b>	Please select the keyboard layout. Only relevant if external keyboard is used.
<b>Selection</b>	Germany, Switzerland, France, USA, USA International, UK, Italy
<b>Factory setting</b>	Germany

---

### Swap mouse buttons

 This function is **not** supported by the **DIN rail version**.

---

<b>Navigation</b>	 Expert → System → Swap mouse buttons Direct access code: 100050/000
<b>Description</b>	Swap function of left and right mouse button.
<b>Selection</b>	No, Yes
<b>Factory setting</b>	No

---

### Paper size

<b>Navigation</b>	 Expert → System → Paper size Direct access code: 540004/000
<b>Description</b>	Please select the paper size of your printer.
<b>Selection</b>	DIN A4, US Letter
<b>Factory setting</b>	DIN A4

---

### Lock operation

 This function is **not** supported by the **DIN rail version**.

---

<b>Navigation</b>	 Expert → System → Lock operation Direct access code: 100060/000
<b>Description</b>	Local operation is locked in cases of inactivity once the set time has elapsed to prevent inadvertent operation (e.g. when cleaning the device). The device is unlocked by pressing the navigator or the OK operating key for 3 s. When using an external keyboard, the device is unlocked with the key combination "Ctrl-Alt-Del".

**Selection** Never, After 2 (5, 10, 15) minutes

**Factory setting** After 5 minutes

---

### LED mode

---

**Navigation**  Expert → System → LED mode  
Direct access code: 100005/000

**Description** NAMUR NE 44: Green LED -> Power supply OK. Red LED -> Measuring signal failure. Red LED flashing -> Maintenance required.  
NAMUR NE 44+: As per NAMUR NE 44, with red LED in the event of a limit value violation.

**Selection** NAMUR NE 44, NAMUR NE 44+

**Factory setting** NAMUR NE 44

---

### PRESET

---

**Navigation**  Expert → System → PRESET  
Direct access code: 000044-000

**Description** Caution: Resets all the parameters to the factory settings!  
 Only visible/editable if the service code has been entered.

**Selection** No, Factory reset, Customer setting

---

### Clear memory

---

**Navigation**  Expert → System → Clear memory  
Direct access code: 059000-000

**Description** Delete internal memory  
 Note: In the version with stainless steel front and touchscreen the internal SD card is also cleared.

**Selection** No, Yes

---

### Confirm deletion

---

<b>Navigation</b>	 Expert → System → Confirm deletion Direct access code: 059001-000
<b>Description</b>	Please confirm that you want to clear the memory.
<b>Selection</b>	No, Yes
<b>Factory setting</b>	No

---

### "Date/time setup" (submenu)

---

<b>Navigation</b>	 Expert → System → Date/time setup
<b>Description</b>	Contains settings for date/time.

---

### Date format

---

<b>Navigation</b>	 Expert → System → Date/time setup → Date format Direct access code: 110000-000
<b>Description</b>	Select in which format the date is to be set and displayed.
<b>Selection</b>	DD.MM.YYYY, MM/DD/YYYY, YYYY-MM-DD
<b>Factory setting</b>	DD.MM.YYYY

---

### Time format

---

<b>Navigation</b>	 Expert → System → Date/time setup → Time format Direct access code: 110001-000
<b>Description</b>	Select in which format the time is to be set and displayed.
<b>Selection</b>	24 hour, 12 hour AM/PM
<b>Factory setting</b>	24 hour

---

### "Date/time" submenu (Online configuration)

---

<b>Navigation</b>	 Expert → System → Date/time setup → Date/time
<b>Description</b>	Contains parameters for setting the date/time.

---

**UTC time zone**  
 (Online configuration)
 

---

**Navigation**  Expert → System → Date/time setup → Date/time → UTC time zone  
 Direct access code: 120000-000

**Description** Display of the current UTC time zone is on (UTC = universal time coordinated).

---

**Current date/time**  
 (Online configuration)
 

---

**Navigation**  Expert → System → Date/time setup → Date/time → Current date/time  
 Direct access code: 120003-000

**Description** Displays the current date and the current time.

---

**"Change date/time" submenu**  
 (Online configuration)
 

---

**Description** Contains parameters for changing the date/time.

**Navigation**  Expert → System → Date/time setup → Change date/time

---

**UTC time zone**  
 (Online configuration)
 

---

**Navigation**  Expert → System → Date/time setup → Date/time → Change date/time → UTC time zone  
 Direct access code: 120010-000

**Description** Set your UTC time zone (UTC = universal time coordinated).

**Selection** -12:00, -11:00: Samoa, -10:00: Hawaii, -09:30: Marquesas, -09:00: Alaska, -08:00: LA, -07:00: Denver, -06:00: Chicago, -05:00: New York, -04:00: Caracas, -03:30: St.John's, -03:00: Brasilia, -02:00: Atlantic, -01:00: Azores, +00:00: London, +01:00: Berlin, +02:00: Cairo, +03:00: Moscow, +03:30: Tehran, +04:00: Abu Dhabi, +04:30: Kabul, +05:00: Islamabad, +05:30: New Delhi, +05:45: Kathmandu, +06:00: Dhaka, +06:30: Pyinmana, +07:00: Bangkok, +08:00: Peking, +08:45, +09:00: Tokyo, +09:30: Adelaide, +10:00: Canberra, +10:30: Lord-Howe, +11:00:Solom.Isl., +11:30: Norfolk, +12:00: Auckland, +12:45: Chatham, +13:00, +14:00

---

**Date/time**  
 (Online configuration)
 

---

<b>Navigation</b>	 Expert → System → Date/time setup → Date/time → Change date/time → Date/time Direct access code: 120013-000
<b>Description</b>	Set the current date and time for the unit here.
<b>User entry</b>	Date/time in set format

---

#### "NT/ST changeover" submenu

---

<b>Navigation</b>	 Expert → System → Date/time setup → NT/ST changeover
<b>Description</b>	Contains settings for normal time/summer time changeover.

---

#### NT/ST changeover

---

<b>Navigation</b>	 Expert → System → Date/time setup → NT/ST changeover → NT/ST changeover Direct access code: 110002-000
<b>Description</b>	Function for summer/normal time changeover. Automatic: Changes to the local regional regulations; Manual: Changeover times can be set in the following addresses; Off: No changeover times required.
<b>Selection</b>	Off, Manual, Automatic
<b>Factory setting</b>	Automatic

---

#### NT/ST region

---

<b>Navigation</b>	 Expert → System → Date/time setup → NT/ST changeover → NT/ST region Direct access code: 110003-000
<b>Description</b>	Selects the regional settings for summer/normal time changeover. Only visible if NT/ST changeover = Automatic.
<b>Selection</b>	Europe, USA
<b>Factory setting</b>	Europe

---

#### Begin summer time

---



---

#### Occurrence

---



<b>Navigation</b>	 Expert → System → Date/time setup → NT/ST changeover → Occurrence Direct access code: 110005-000
<b>Description</b>	Day, when in the spring a change from normal to summer time occurs. Visible for NT/ST changeover = Automatic or Manual. Only editable if NT/ST changeover = Manual.
<b>Selection</b>	1., 2., 3., 4., Last
<b>Factory setting</b>	Last

**Day**

<b>Navigation</b>	 Expert → System → Date/time setup → NT/ST changeover → Day Direct access code: 110006-000
<b>Description</b>	Day, when in the spring a change from normal to summer time occurs. Visible for NT/ST changeover = Automatic or Manual. Only editable if NT/ST changeover = Manual.
<b>Selection</b>	Sunday, Monday, Tuesday, Wednesday, Thursday, Friday, Saturday
<b>Factory setting</b>	Sunday

**Month**

<b>Navigation</b>	 Expert → System → Date/time setup → NT/ST changeover → Month Direct access code: 110007-000
<b>Description</b>	Month, when in the spring a change from normal to summer time occurs. Visible for NT/ST changeover = Automatic or Manual. Only editable if NT/ST changeover = Manual.
<b>Selection</b>	January, February, March, April, May, June, July, August, September, October, November, December
<b>Factory setting</b>	March

**Date**

<b>Navigation</b>	 Expert → System → Date/time setup → NT/ST changeover → Date Direct access code: 110008-000
<b>Description</b>	Date next spring when a change from normal to summer time occurs. Only visible if NT/ST changeover = Automatic or Manual. Cannot be edited.

---

**Time**

---

<b>Navigation</b>	 Expert → System → Date/time setup → NT/ST changeover → Time Direct access code: 110009-000
<b>Description</b>	Time at which the changeover from normal time to summer time is forwarded by one hour (format: hh:mm). Visible for NT/ST changeover = Automatic or Manual. Only editable if NT/ST changeover = Manual.
<b>User entry</b>	Time in set time format
<b>Factory setting</b>	02:00

---

**End summer time**



---



---

**Occurrence**



---

<b>Navigation</b>	 Expert → System → Date/time setup → NT/ST changeover → Occurrence Direct access code: 110011-000
<b>Description</b>	Day, when in the autumn a change from summer to normal time occurs. Visible for NT/ST changeover = Automatic or Manual. Only editable if NT/ST changeover = Manual.
<b>Selection</b>	1., 2., 3., 4., Last
<b>Factory setting</b>	Last

---

**Day**



---

<b>Navigation</b>	 Expert → System → Date/time setup → NT/ST changeover → Day Direct access code: 110012-000
<b>Description</b>	Day, when in the autumn a change from summer to normal time occurs. Visible for NT/ST changeover = Automatic or Manual. Only editable if NT/ST changeover = Manual.
<b>Selection</b>	Sunday, Monday, Tuesday, Wednesday, Thursday, Friday, Saturday
<b>Factory setting</b>	Sunday

---

**Month**



---

<b>Navigation</b>	 Expert → System → Date/time setup → NT/ST changeover → Month Direct access code: 110013-000
<b>Description</b>	Month, when in the autumn a change from summer to normal time occurs. Visible for NT/ST changeover = Automatic or Manual. Only editable if NT/ST changeover = Manual.
<b>Selection</b>	January, February, March, April, May, June, July, August, September, October, November, December
<b>Factory setting</b>	October

---

**Date**



---

<b>Navigation</b>	 Expert → System → Date/time setup → NT/ST changeover → Date Direct access code: 110014-000
<b>Description</b>	Date next autumn when summer time changes back to normal time. Only visible if NT/ST changeover = Automatic or Manual. Cannot be edited.

---

**Time**



---

<b>Navigation</b>	 Expert → System → Date/time setup → NT/ST changeover → Time Direct access code: 110015-000
<b>Description</b>	Time at which the changeover from summer time to normal time is turned back by one hour (in the set time format). Visible for NT/ST changeover = Automatic or Manual. Only editable if NT/ST changeover = Manual.
<b>User entry</b>	Time in set time format
<b>Factory setting</b>	02:00

---

**"SNTP" submenu**



---

<b>Navigation</b>	 Expert → System → Date/time setup → SNTP
<b>Description</b>	Contains settings for time synchronization using the Simple Network Time Protocol (SNTP).

---

**SNTP**



---

<b>Navigation</b>	 Expert → System → Date/time setup → SNTP Direct access code: 110020-000
<b>Description</b>	If switched on, time synchronization is carried out via SNTP once a day. Note: Only possible via Ethernet. Port 123 must be open in the firewall. The user/network administrator is responsible for the accuracy of the time server.
<b>Selection</b>	No, Yes
<b>Factory setting</b>	No

---

**SNTP server 1**



---

<b>Navigation</b>	 Expert → System → Date/time setup → SNTP server → SNTP server 1 Direct access code: 110021-000
<b>Description</b>	Please specify the address of the time server (or the IP address). Note: The DNS server must be configured (see Communication/Ethernet). Your administrator can provide the address where necessary.
<b>User entry</b>	Text field

---

**SNTP server 2**



---

<b>Navigation</b>	 Expert → System → Date/time setup → SNTP server → SNTP server 2 Direct access code: 110025-000
<b>Description</b>	Shows the IP address of the time server if it was automatically allocated via DHCP. Non-editable display text.  An attempt is always made to synchronize the time via SNTP server 1 first (provided it is configured) DHCP must be switched on (see Communication/Ethernet). DHCP server: Option 42

---

**"Security" submenu**



---

<b>Navigation</b>	 Expert → System → Security
<b>Description</b>	Contains settings that protect the device against unauthorized operation and configuration.

---

**Protected by**



---

<b>Navigation</b>	 Expert → System → Security → Protected by Direct access code: 100006-000
<b>Description</b>	Configure how the device should be protected.
<b>Selection</b>	Open access, access code, FDA 21 CFR Part 11, user roles
<b>Factory setting</b>	Open access

---

**Access code**



---

<b>Navigation</b>	 Expert → System → Security → Access code Direct access code: 100000-000
<b>Description</b>	Using this code, setup access can be protected from unauthorized persons. In order to change any parameter the correct code must be entered. Factory setting: "0", i.e. changes can be made at any time. Hint: Make a note of the code and store in a safe place. Only visible if "Protected by" = "Access code"
<b>User entry</b>	4-digit number
<b>Factory setting</b>	0

---

**Set point code**



---

<b>Navigation</b>	 Expert → System → Security → Set point code Direct access code: 100030-000
<b>Description</b>	If the unit is protected by an access code a set point code can also be defined. The user can change the set points once the set point code is entered. All other operating positions remain locked, however. Only visible if an activation code has been defined. Factory default: "0" means that alarm set points can only be changed by entering the access code.  Alarm set point code and access code should not be identical!
<b>User entry</b>	4-digit number
<b>Factory setting</b>	0

---

**Lock hardware**



---

<b>Navigation</b>	 Expert → System → Security → Lock hardware Direct access code: 100099-000
<b>Description</b>	Device functions/interfaces that are not used can be switched off for security reasons.  Fieldbus systems may also be affected in the case of Ethernet or the serial interface. Please follow the operating instructions.
<b>Selection</b>	<b>Panel version:</b> Ethernet (all ports/services), USB A socket front, USB A socket back, USB B socket front, serial interface, SD card <b>DIN rail version:</b> Ethernet (all ports/services), USB A socket, USB B socket, serial interface, SD card
<b>Factory setting</b>	No lock

---

**"Authentication" submenu**



---

<b>Navigation</b>	 Expert → System → Security → Authentication
<b>Description</b>	Define the passwords for the various user roles to allow device access. Only visible if "Protected by" = "User roles"

---

**Operator**  
**ID: operator**  
**Password**



---

<b>Navigation</b>	 Expert → System → Security → Authentication → Password Direct access code: 470105/000
<b>Description</b>	Enter a password for this user account.
<b>Selection</b>	Text entry max. 12 characters
<b>Factory setting</b>	operator

---

**Administrator**  
**ID: admin**  
**Password**

---

<b>Navigation</b>	 Expert → System → Security → Authentication → Password Direct access code: 470102/000
<b>Description</b>	Enter a password for this user account.

**Selection** Text entry max. 12 characters

**Factory setting** admin

---

**Service  
ID: service  
Password**

---

**Navigation**  Expert → System → Security → Authentication → Password  
Direct access code: 470101/000

**Description** Enter a password for this user account.

**Selection** Text entry max. 12 characters

**Factory setting** service

---

**"External memory" submenu**

---

**Navigation**  Expert → System → External memory

**Description** Settings for the external data carrier, amongst other things which data is to be stored in which format on the external data carrier.

---

**Save as**

---

**Navigation**  Expert → System → External memory → Save as  
Direct access code: 140000-000

**Description** "Protected format": All data is stored in a manipulation protected encrypted format. This data can only be visualized by the PC analysis software supplied.  
"Open format": Data is stored in a CSV format, this can be opened by a number of different programs (for e.g. MS Excel) (Attention: no manipulation security).

**Selection** Protected format, Open format (\*.csv)



Note: For the device version with stainless steel front and touch operation, only the selection "Protected format" is possible!

**Factory setting** Protected format

---



**SD card**

---

---

**Memory build-up**



---

<b>Navigation</b>	 Expert → System → External memory → Memory build-up Direct access code: 140001-000
<b>Description</b>	"Stack memory": No more data can be stored once the data carrier is full. "Ring memory": Once the data carrier is full the oldest data is deleted so that new data can be stored (First in first out (FIFO)).  The "Ring memory" setting refers only to the automatic storage of measured values. Manual save functions ("Operation -> SD card -> Update/Save measured values") are not affected.
<b>Selection</b>	Stack memory, Ring memory (FIFO)  "Ring memory" can be selected only if "Save as" is set to "Protected format" (and not "CSV").
<b>Factory setting</b>	Stack memory

---

**Warning at**



---

<b>Navigation</b>	 Expert → System → External memory → Warning at Direct access code: 140005-000
<b>Description</b>	Issues a warning before the data carrier is x% full. A warning is indicated on the device and this is also stored in the event buffer. A relay can also be switched.  Only for external SD card (does not apply to USB stick)!
<b>User entry</b>	0 to 99%
<b>Factory setting</b>	90

---

**Switches relay**

---

<b>Navigation</b>	 Expert → System → External memory → Switches relay Direct access code: 140006-000
<b>Description</b>	When the warning "Data carrier full" is displayed a relay can also be switched on.
<b>Selection</b>	Not used, Relay x All the available relays are displayed.
<b>Factory setting</b>	Not used



---

**CSV settings**

---



Also configurable if "Protected format" is set.

---

**Separator for CSV**

---

<b>Navigation</b>	Expert → System → External memory → Separator for CSV Direct access code: 140002-000
<b>Description</b>	Configure which separator is used by your application (e.g. in Excel = semicolon).
<b>Selection</b>	Comma, Semicolon
<b>Factory setting</b>	Semicolon

---

**Date/time**

---

<b>Navigation</b>	Expert → System → External memory → Date/time Direct access code: 140003-000
<b>Description</b>	Please select if the date and time should be stored in one column or separate columns when data is saved in CSV format files.
<b>Selection</b>	One column, Separate columns
<b>Factory setting</b>	Separate columns

---

**Operational time**

---

<b>Navigation</b>	Expert → System → External memory → Operational time Direct access code: 140004-000
<b>Description</b>	Please select in which format operation times will be stored/displayed.
<b>Selection</b>	0 seconds, 0.0000 hours, 0.00000 days, 0000h00:00
<b>Factory setting</b>	0000h00:00

---

**"Messages" submenu**

---

<b>Navigation</b>	Expert → System → Messages
-------------------	----------------------------

**Description** Contains settings for displaying/acknowledging messages. Examples of messages include: messages triggered by set points; messages triggered by a digital input; error messages; etc.

---

### Acknowledging messages

---

**Navigation**  Expert → System → Messages → Acknowledging messages  
Direct access code: 100040-000

**Description** The time the message is acknowledged can be saved in the events list.  
 This setting cannot be altered if the user administration system is activated (FDA 21 CFR Part 11).

**Selection** Do not save, Save

**Factory setting** Do not save

---

### Switches relay

---

**Navigation**  Expert → System → Messages → Switches relay  
Direct access code: 100042-000

**Description** A relay can be switched as soon as a message that has to be confirmed is displayed (e.g. on/off message, device errors etc.).  
The relay takes the initial state as soon as all messages have been confirmed.

**Selection** Not used, Relay x  
All the available relays are displayed.

**Factory setting** Not used

---

### "Screensaver" submenu

 This function is **not** supported by the **DIN rail version**.

**Navigation**  Expert → System → Screensaver

**Description** To increase the life span of the LCD the rear illumination can be switched off (= screensaver).

---

### Screensaver

 This function is **not** supported by the **DIN rail version**.



---

<b>Navigation</b>	 Expert → System → Screensaver → Screensaver Direct access code: 160000-000
<b>Description</b>	"Switched off": LCD is always switched on. "Switch on for x min.": Display goes dark after x minutes. All other functions remain in operation. Press an operating key: Illumination is switched back on. "Switched daily": Enter time span.
<b>Selection</b>	Switched off, On after 10 min, On after 30 min, On after 60 min, Switched daily, Control input
<b>Factory setting</b>	Switched off This setting has no effect if the screensaver is controlled by a digital input.

---

### ON daily from

---

<b>Navigation</b>	 Expert → System → Screensaver → ON daily from Direct access code: 160001-000
<b>Description</b>	Set time (hh:mm) as of when the screensaver should be switched on (e.g. shift end time).  The screensaver is switched off as soon as the device is operated via onsite operation. After 1 min of inactivity it switches back on automatically. Only visible if screensaver = Switched daily
<b>User entry</b>	Time (hh:mm)
<b>Factory setting</b>	20:00

---

### OFF daily from

---

<b>Navigation</b>	 Expert → System → Screensaver → OFF daily from Direct access code: 160002-000
<b>Description</b>	Set time (hh:mm) as of when the screensaver should be switched off (e.g. shift start time). Only visible if screensaver = Switched daily
<b>User entry</b>	Time (hh:mm)
<b>Factory setting</b>	07:00

---

### Alarm response

---



<b>Navigation</b>	 Expert → System → Screensaver → Alarm response Direct access code: 160003-000
-------------------	--

<b>Description</b>	"Off on alarm": If limit value violations occur or status signal "Maintenance required (Mxxx)" or "Function check (Cxxx)" is active, the screensaver will be automatically deactivated. "Always on": If limit value violations occur or status signal "Maintenance required (Mxxx)" or "Function check (Cxxx)" is active, the screensaver will not be deactivated.  Active messages that require acknowledgment or an active status signal "Failure (Fxxx)" or "Out of specification (Sxxx)" deactivate the screensaver always.
<b>Selection</b>	Off on alarm, Always on
<b>Factory setting</b>	Off on alarm

---

### "Barcode reader" submenu

 This function is **not** supported by the **DIN rail version**.

<b>Navigation</b>	 Expert → System → Barcode reader
<b>Description</b>	Settings for barcode reader (only relevant if a USB barcode reader is connected to the device).  Notes on operating a barcode reader: it must behave like a HID keyboard; texts must be terminated with a carriage return.

---

### Character set

<b>Navigation</b>	 Expert → System → Barcode reader → Character set Direct access code: 100021-000
<b>Description</b>	Please select the keyboard layout.
<b>Selection</b>	Germany, Switzerland, France, USA, USA International, UK, Italy
<b>Factory setting</b>	Germany

---

### Save as event

<b>Navigation</b>	 Expert → System → Barcode reader → Save as event Direct access code: 100022-000
<b>Description</b>	The device can save texts read in using a barcode reader in the events list. Texts are stored as events if one of the following conditions is NOT met: <ul style="list-style-type: none"> <li>■ A command sequence was read in</li> <li>■ The dialog where batch information is input is active</li> <li>■ The dialog for testing the barcode reader is active</li> <li>■ The "Save text" function is executed</li> </ul>
<b>Selection</b>	No, Yes

**Factory setting** No

---

### Timeout sequences

---

**Navigation**  Expert → System → Barcode reader → Timeout sequences  
Direct access code: 100023-000

**Description** Specify the number of seconds after which a command sequence is canceled if the necessary data are not read in.

**User entry** Time in seconds (10-180)

**Factory setting** 30

---

### "Device options" submenu

---

**Navigation**  Expert → System → Device options

**Description** Hardware and software options of the device.

---

### Activation code (Online configuration)

---

**Navigation**  Expert → System → Device options → Activation code  
Direct access code: 000057-000

**Description** Here, you can enter a code to enable the device options.  
The options that can be retrofitted are listed under "spare parts" →  95  
Note: When an activation code is entered, the device is restarted in order to enable the new option.

- 
  - The activation code entered is not displayed, i.e. this parameter is always empty following a restart.
  - Pay attention to case-sensitivity.

**User entry** Text

---

### Slot 1 (Online configuration)

---

**Navigation**  Expert → System → Device options → Slot 1  
Direct access code: 990000-000

<b>Description</b>	Shows hardware or software options. Cannot be edited.  The assignment can be specified in the PC operating software for offline configuration.
<b>Selection</b>	Not assigned, Universal inputs, HART

---

#### Slot 2 (Online configuration)

---

<b>Navigation</b>	 Expert → System → Device options → Slot 2 Direct access code: 990001-000
-------------------	---

<b>Description</b>	Shows hardware or software options. Cannot be edited.  The assignment can be specified in the PC operating software for offline configuration.
<b>Selection</b>	Not assigned, Universal inputs, HART

---

#### Slot 3 (Online configuration)

---

<b>Navigation</b>	 Expert → System → Device options → Slot 3 Direct access code: 990002-000
-------------------	---

<b>Description</b>	Shows hardware or software options. Cannot be edited.  The assignment can be specified in the PC operating software for offline configuration.
<b>Selection</b>	Not assigned, Universal inputs, HART

---

#### Slot 4 (Online configuration)

---

<b>Navigation</b>	 Expert → System → Device options → Slot 4 Direct access code: 990003-000
-------------------	---

<b>Description</b>	Shows hardware or software options. Cannot be edited.  The assignment can be specified in the PC operating software for offline configuration.
<b>Selection</b>	Not assigned, Universal inputs, HART

---

**Slot 5**  
 (Online configuration)
 

---

**Navigation**  Expert → System → Device options → Slot 5  
 Direct access code: 990004-000

**Description** Shows hardware or software options.  
 Cannot be edited.

 The assignment can be specified in the PC operating software for offline configuration.

**Selection** Not assigned, Universal inputs, Digital inputs, HART

---

**Communication**  
 (Online configuration)
 

---

**Navigation**  Expert → System → Device options → Communication  
 Direct access code: 990006-000

**Description** Shows hardware or software options.  
 Cannot be edited.

**Selection** USB + Ethernet, USB + Ethernet + RS232/485

---

**Fieldbus**  
 (Online configuration)
 

---

**Navigation**  Expert → System → Device options → Fieldbus  
 Direct access code: 990005-000

**Description** Shows hardware or software options.  
 Cannot be edited.

**Selection** Not available, Modbus Slave, Profibus DP, EtherNet/IP, PROFINET

---

**Modbus Master**  
 (Online configuration)
 

---

**Navigation**  Expert → System → Device options → Modbus Master  
 Direct access code: 990008-000

<b>Description</b>	Shows hardware or software options. Cannot be edited.  Detailed descriptions of this device option can be found in the associated documentation.
<b>Selection</b>	No, Yes

---

### Application (Online configuration)

---

<b>Navigation</b>	 Expert → System → Device options → Application Direct access code: 990007-000
-------------------	--

<b>Description</b>	Shows hardware or software options. Cannot be edited.
--------------------	--

<b>Selection</b>	Standard, Maths, Telealarm, Telealarm + wastewater, Batch, Telealarm + batch, Energy, Energy + Telealarm
------------------	--

---

### Front of housing (Online configuration)

---

<b>Navigation</b>	 Expert → System → Device options → Front of housing Direct access code: 990009-000
-------------------	---

<b>Description</b>	Shows hardware or software options. Cannot be edited.
--------------------	--

<b>Selection</b>	DIN rail; With interfaces; Stainless steel without interfaces
------------------	---

## 17.1.2 "Inputs" submenu

Settings for the analog and digital inputs.

---

### "Universal inputs" submenu

---

<b>Navigation</b>	 Expert → System → Inputs → Universal inputs
-------------------	---

<b>Description</b>	Settings for the connected measuring points.
--------------------	--

---

### Add input

---

<b>Navigation</b>	 Expert → System → Inputs → Universal inputs → Add input Direct access code: 222000/000
-------------------	---



<b>Description</b>	Addition of an input that must be switched on and configured according to the input signal.
<b>Selection</b>	No, Universal input x
<b>Factory setting</b>	No

---

### Delete input



---

<b>Navigation</b>	 Expert → System → Inputs → Universal inputs → Delete input Direct access code: 222001/000
<b>Description</b>	Delete an input configuration.
<b>Selection</b>	No, Universal input x
<b>Factory setting</b>	No

---

### "Universal input x" submenu

---

<b>Navigation</b>	 Expert → System → Inputs → Universal inputs → Universal input x
<b>Description</b>	View or change settings for the selected channel.  x = place holder for selected universal input

---

### Signal

---

<b>Navigation</b>	 Expert → Inputs → Universal inputs → Universal input x → Signal Direct access code: 220000-0xx Examples: Universal input 1: 220000-000; Universal input 12: 220000-011
<b>Description</b>	Select the type of signal connected (current, voltage, etc.). The channel is switched off if no signal type is selected (factory default).
<b>Selection</b>	Switched off, Current, Voltage, Resistance thermometer, Thermocouple, Pulse counter, Frequency input, Profibus DP (Option), Modbus Slave (option), Modbus Master (option), HART (option), EtherNet/IP (option), PROFINET (option)
<b>Factory setting</b>	Switched off

---

### Range

---

<b>Navigation</b>	 Expert → Inputs → Universal inputs → Universal input x → Range Direct access code: 220001-0xx Examples: Universal input 1: 220001-000; Universal input 12: 220001-011
<b>Description</b>	Select the input range or which resistance thermometer/thermocouple is connected. The respective terminal layout can be found in the operating manual or on the rear of the unit. Only visible if signal ≠ Switched off
<b>Selection</b>	Switched off Current: 4-20 mA, 0-20 mA, 0-5 mA, 0-20 mA squared, 4-20 mA squared, ±20 mA Voltage: 0-1 V, 0-10 V, 0-5 V, 1-5 V, ±150 mV, ±1 V, ±10 V, ±30 V, 0-1 V squared, 0-10 V squared, 1-5 V squared Resistance thermometer: Pt100 (IEC), Pt100 (JIS), Pt100 (GOST), Pt500 (IEC), Pt500 (JIS), Pt1000 (IEC), Pt1000 (JIS), Pt46 (GOST), Pt50 (GOST), Cu50 (GOST, a=4260), Cu50 (GOST, a=4280), Cu53 (GOST, a=4280), Cu100 (GOST, a=4280) Thermocouple: Type A (W5Re-W20Re), type B (Pt30Rh-Pt6Rh), type C (W5Re-W26Re), type D (W3Re-W25Re), type J (Fe-CuNi), type K (NiCr-Ni), type L (Fe-CuNi), type L (NiCr-CuNi, GOST), type N (NiCrSi-NiSi), type R (Pt13Rh-Pt), type S (Pt10Rh-Pt), type T (Cu-CuNi) Pulse counter Frequency input Profibus DP (option) Modbus (option) Modbus Master (option) HART (option) EtherNet/IP (option) PROFINET (option)
<b>Factory setting</b>	Switched off

---

**Value**



---

<b>Navigation</b>	 Expert → Inputs → Universal inputs → Universal input x → Value Direct access code: 220023-0xx Examples: Universal input 1: 220023-000; Universal input 12: 220023-011
<b>Description</b>	Specify the value, which was read out digitally via HART, that should be recorded/processed. Only visible if signal = HART
<b>Selection</b>	Switched off, Value x All the available values are displayed.
<b>Factory setting</b>	Switched off

---

**Measured value type**

---

<b>Navigation</b>	 Expert → Inputs → Universal inputs → Universal input x → Measured value type Direct access code: 220022-0xx Examples: Universal input 1: 220022-000; Universal input 12: 220022-011
-------------------	---

<b>Description</b>	Type of measured value received. Only visible if signal = HART or Modbus Master.
<b>Selection</b>	Instantaneous value, Counter
<b>Factory setting</b>	Instantaneous value

---

### Connection

---

<b>Navigation</b>	 Expert → Inputs → Universal inputs → Universal input x → Connection Direct access code: 220002-0xx Examples: Universal input 1: 220002-000; Universal input 12: 220002-011
<b>Description</b>	Specify whether RTDs are connected as 2-, 3- or 4-wire systems. Only visible if signal = Resistance thermometer
<b>Selection</b>	2-wire, 3-wire, 4-wire
<b>Factory setting</b>	4-wire

---

### Transmission protocol

---

<b>Navigation</b>	 Expert → Inputs → Universal inputs → Universal input x → Transmission protocol Direct access code: 220049-0xx Examples: Universal input 1: 220049-000; Universal input 12: 220049-011
<b>Description</b>	Modbus TCP: Addressing Modbus TCP slaves. Modbus TCP with slave address: Addressing gateways which use a table to link the address to the right slave. Modbus RTU via TCP: Transmission of the pure Modbus RTU protocol with CRC sum. Used in signal converters for Ethernet -> RS485. Only visible if signal = Modbus Master
<b>Selection</b>	Modbus TCP, Modbus TCP with slave address, Modbus RTU over TCP
<b>Factory setting</b>	Modbus TCP

---

### IP address

---

<b>Navigation</b>	 Expert → Inputs → Universal inputs → Universal input x → IP address Direct access code: 220041-0xx Examples: Universal input 1: 220041-000; Universal input 12: 220041-011
<b>Description</b>	Address of Modbus slave Only visible if signal = Modbus Master

**User entry** IP address

**Factory setting** 0.0.0.0

---

### Port

---

**Navigation**  Expert → Inputs → Universal inputs → Universal input x → Port  
 Direct access code: 220048-0xx  
 Examples: Universal input 1: 220048-000; Universal input 12: 220048-011

**Description** Modbus slave port  
 Only visible if signal = Modbus Master

**User entry** Number (max. 5 digits)

**Factory setting** 502

---

### Slave address

---

**Navigation**  Expert → Inputs → Universal inputs → Universal input x → Slave address  
 Direct access code: 220040-0xx  
 Examples: Universal input 1: 220040-000; Universal input 12: 220040-011

**Description** Address of Modbus slave  
 Only visible if signal = Modbus Master

**User entry** Number (1 to 255)

**Factory setting** 1

---

### Readout function

---

**Navigation**  Expert → Inputs → Universal inputs → Universal input x → Readout function  
 Direct access code: 220042-0xx  
 Examples: Universal input 1: 220042-000; Universal input 12: 220042-011

**Description** Modbus function with which the registers are to be read out.  
 Only visible if signal = Modbus Master

**Selection** Read Input Register (3xxxxx), Read Holding Register (4xxxxx)

**Factory setting** Read Input Register (3xxxxx)

---

**Register address**



---

<b>Navigation</b>	 Expert → Inputs → Universal inputs → Universal input x → Register address Direct access code: 220043-0xx Examples: Universal input 1: 220043-000; Universal input 12: 220043-011
<b>Description</b>	Register address 1-65535 Only visible if signal = Modbus Master
<b>User entry</b>	Number (1 to 65535)
<b>Factory setting</b>	1

---

**Data type**



---

<b>Navigation</b>	 Expert → Inputs → Universal inputs → Universal input x → Data type Direct access code: 220044-0xx Examples: Universal input 1: 220044-000; Universal input 12: 220044-011
<b>Description</b>	Describes the data type of the value received and its sequence of bytes. Only visible if signal = Modbus Master
<b>Selection</b>	INT16, UINT16, INT32_B, INT32_L, UINT32_B, UINT32_L, FLOAT_B, FLOAT_L, DOUBLE_B, DOUBLE_L
<b>Factory setting</b>	FLOAT_B

---

**Channel ident.**



---

<b>Navigation</b>	 Expert → Inputs → Universal inputs → Universal input x → Channel ident. Direct access code: 220003-0xx Examples: Universal input 1: 220003-000; Universal input 12: 220003-011
<b>Description</b>	Name of the measuring point connected to this input. Only visible if signal ≠ Switched off
<b>User entry</b>	Text (16 characters)
<b>Factory setting</b>	Channel x

---

**Plot type**



---

<b>Navigation</b>	 Expert → Inputs → Universal inputs → Universal input x → Plot type Direct access code: 220016-0xx Examples: Universal input 1: 220016-000; Universal input 12: 220016-011
<b>Description</b>	The analog inputs are scanned in a 100ms cycle. Dependent on the store cycle the selected data is selected, stored and displayed from the scanned values.
<b>Selection</b>	Instantaneous value, Average, Minimum value, Maximum value, Minimum + Maximum, Counter, Current value + Counter
<b>Factory setting</b>	Average

---

### Time base

---

<b>Navigation</b>	 Expert → Inputs → Universal inputs → Universal input x → Time base Direct access code: 220025-0xx Examples: Universal input 1: 220025-000; Universal input 12: 220025-011
<b>Description</b>	A current value can be determined from the counter reading with the aid of the time base e.g. input liters, time base = second → current value = liters/second. Only visible if signal = "Pulse counter" and plot type = "Current value + Counter"
<b>Selection</b>	Second (s), Minute (min), Hour (h), Day (d)
<b>Factory setting</b>	Second (s)

---

### Engineering unit

---

<b>Navigation</b>	 Expert → Inputs → Universal inputs → Universal input x → Engineering unit Direct access code: 220004-0xx Examples: Universal input 1: 220004-000; Universal input 12: 220004-011
<b>Description</b>	Specify the technical (physical) unit for the measuring point connected to this input. Only visible if signal ≠ Switched off
<b>User entry</b>	Text (6 characters)

---

### Unit/dimension counter

---

<b>Navigation</b>	 Expert → Inputs → Universal inputs → Universal input x → Unit/dimension counter Direct access code: 220024-00x Examples: Universal input 1: 220024-000; Universal input 12: 220024-011
<b>Description</b>	Technical unit of the count input, e.g. gal, cf, ... . Only visible if signal = "Pulse counter" and plot type = "Current value + Counter"

**User entry** Text (max. 6 characters)

---

### Pulse counter

---

**Navigation**  Expert → Inputs → Universal inputs → Universal input x → Pulse counter  
Direct access code: 220017-0xx  
Examples: Universal input 1: 220017-000; Universal input 12: 220017-011

**Description** Specify whether the pulse counter is a fast or slow (up to max. 25 Hz) counter. For example if the number of state changes from a relay are to be monitored then you must set "up to 25Hz".  
Only visible if signal = Pulse counter

**Selection** Up to 13kHz, Up to 25Hz

**Factory setting** Up to 13kHz

---

### Pulse value

---

**Navigation**  Expert → Inputs → Universal inputs → Universal input x → Pulse value  
Direct access code: 220010-0xx  
Examples: Universal input 1: 220010-000; Universal input 12: 220010-011

**Description** Factor, that when multiplied by the input signal results in the required physical value.  
Example: 1 pulse equals 5 m<sup>3</sup> -> enter a "5".  
Only visible if signal = Pulse counter

**User entry** Number, max. 8 digits

**Factory setting** 1

---

### Calc. factor

---

**Navigation**  Expert → Inputs → Universal inputs → Universal input x → Calc. factor  
Direct access code: 220045-0xx  
Examples: Universal input 1: 220045-000; Universal input 12: 220045-011

**Description** Factor for converting the counter (e.g. the transmitter returns m<sup>3</sup>/100 -> desired unit is m<sup>3</sup> --> enter 0.01 as the factor)  
Only visible if signal = Modbus Master

**User entry** Number (max. 15 digits)

**Factory setting** 1.0

---

**Decimal point**



---

<b>Navigation</b>	 Expert → Inputs → Universal inputs → Universal input x → Decimal point Direct access code: 220005-0xx Examples: Universal input 1: 220005-000; Universal input 12: 220005-011
<b>Description</b>	Number of places after decimal point for the display. Only visible if signal ≠ Switched off
<b>Selection</b>	None, One (X.Y), Two (X.YY), Three (X.YYY), Four (X.YYYY), Five (X.YYYYY)
<b>Factory setting</b>	One (X.Y)

---

**Start value range**



---

<b>Navigation</b>	 Expert → Inputs → Universal inputs → Universal input x → Start value range Direct access code: 220046-0xx Examples: Universal input 1: 220046-000; Universal input 12: 220046-011
<b>Description</b>	Scaling of the Modbus value Here, enter the lower-range value for the scale which corresponds to the start of the measuring range. Only visible if signal = Modbus Master
<b>User entry</b>	Number (max. 8 digits)
<b>Factory setting</b>	0

---

**End value range**

---

<b>Navigation</b>	 Expert → Inputs → Universal inputs → Universal input x → End value range Direct access code: 220047-0xx Examples: Universal input 1: 220047-000; Universal input 12: 220047-011
<b>Description</b>	Scaling of the Modbus value Here, enter the upper-range value for the scale which corresponds to the end of the measuring range. Only visible if signal = Modbus Master
<b>User entry</b>	Number (max. 8 digits)
<b>Factory setting</b>	100

---



**Lower frequency**

---



<b>Navigation</b>	 Expert → Inputs → Universal inputs → Universal input x → Lower frequency Direct access code: 220018-0xx Examples: Universal input 1: 220018-000; Universal input 12: 220018-011
<b>Description</b>	Configure the lower frequency that corresponds to the start of the measuring range. Only visible if signal = Frequency input
<b>User entry</b>	0 to 12500 (Hz)
<b>Factory setting</b>	5.0 (Hz)



**Range start**

<b>Navigation</b>	 Expert → Inputs → Universal inputs → Universal input x → Range start Direct access code: 220006-0xx Examples: Universal input 1: 220006-000; Universal input 12: 220006-011
<b>Description</b>	Transmitters convert the physical measured variable to standardized signals. Enter the start of the measuring range here.   <ul style="list-style-type: none"> <li>▪ The start and end of the measuring range may not be identical.</li> <li>▪ The start of the measuring range can also be larger than the end (e.g. for deep wells).</li> <li>▪ The parameter can be defined independently of the number of decimal places configured for the measured value as these are only taken into consideration for the display.</li> </ul>
<b>User entry</b>	Number (max. 8 digits)
<b>Factory setting</b>	0 (Depends on the input signal selected)

**Upper frequency**

<b>Navigation</b>	 Expert → Inputs → Universal inputs → Universal input x → Upper frequency Direct access code: 220019-0xx Examples: Universal input 1: 220019-000; Universal input 12: 220019-011
<b>Description</b>	Configure the upper frequency that corresponds to the end of the measuring range. Only visible if signal = Frequency input
<b>User entry</b>	0 to 12500 (Hz)
<b>Factory setting</b>	1000.0 (Hz)



**Meas. range end**

<b>Navigation</b>	 Expert → Inputs → Universal inputs → Universal input x → Meas. range end Direct access code: 220007-0xx Examples: Universal input 1: 220007-000; Universal input 12: 220007-011
<b>Description</b>	Transmitters convert the physical measured variable to standardized signals. Enter the end of the measuring range here. <ul style="list-style-type: none"> <li> <ul style="list-style-type: none"> <li>▪ The start and end of the measuring range may not be identical.</li> <li>▪ The end of the measuring range can also be smaller than the start (e.g. for deep wells).</li> <li>▪ The parameter can be defined independently of the number of decimal places configured for the measured value as these are only taken into consideration for the display.</li> </ul> </li> </ul>
<b>User entry</b>	Number (max. 8 digits)
<b>Factory setting</b>	100 (Depends on the input signal selected)

---

**Zoom start**



---

<b>Navigation</b>	 Expert → Inputs → Universal inputs → Universal input x → Zoom start Direct access code: 220011-0xx Examples: Universal input 1: 220011-000; Universal input 12: 220011-011
<b>Description</b>	If the whole value range is not used, you can configure the lower value of the required section here. The zoom has no influence on the storage. <ul style="list-style-type: none"> <li> <ul style="list-style-type: none"> <li>▪ The zoom can also be set outside the measuring range. The only restriction is that the start and end of the zoom may not be identical.</li> <li>▪ If the signal or the range is changed, the zoom is corrected if it no longer fits the measuring range.</li> <li>▪ The zoom start can also be larger than the zoom end. The device will automatically rotate the values on the display.</li> </ul> </li> </ul>
<b>User entry</b>	Number (max. 8 digits)
<b>Factory setting</b>	0 (Depends on the input signal selected)

---

**Zoom end**

---

<b>Navigation</b>	 Expert → Inputs → Universal inputs → Universal input x → Zoom end Direct access code: 220012-0xx Examples: Universal input 1: 220012-000; Universal input 12: 220012-011
<b>Description</b>	Like "Zoom start". Enter the upper value of the required range here. <ul style="list-style-type: none"> <li> <ul style="list-style-type: none"> <li>▪ The zoom can also be set outside the measuring range. The only restriction is that the start and end of the zoom may not be identical.</li> <li>▪ If the signal or the range is changed, the zoom is corrected if it no longer fits the measuring range.</li> <li>▪ The zoom end can also be smaller than the zoom start. The device will automatically rotate the values on the display.</li> </ul> </li> </ul>

<b>User entry</b>	Number (max. 8 digits)
<b>Factory setting</b>	100 (Depends on the input signal selected)

---

### Damping

---

<b>Navigation</b>	 Expert → Inputs → Universal inputs → Universal input x → Damping Direct access code: 220008-0xx Examples: Universal input 1: 220008-000; Universal input 12: 220008-011
<b>Description</b>	The more unwanted interference there is on the measurement signal the higher the value that should be entered here. Result: Fast changes will be damped/suppressed. Only visible if signal = Current, Voltage, Resistance thermometer or Thermocouple
<b>User entry</b>	0 to 999.9 s
<b>Factory setting</b>	Current, voltage: 0.0 s Resistance thermometer, thermocouple: 0.2 s

---

### Comparison point

---

<b>Navigation</b>	 Expert → Inputs → Universal inputs → Universal input x → Comparison point Direct access code: 220013-0xx Examples: Universal input 1: 220013-000; Universal input 12: 220013-011
<b>Description</b>	Intern: Compensation of the voltage error by measuring the terminal temperature. Extern: Compensation of the voltage error by using an external controlled comparison measurement point. Only visible if signal = Thermocouple
<b>Selection</b>	Internal, External
<b>Factory setting</b>	Internal

---

### Comparison temp.

---

<b>Navigation</b>	 Expert → Inputs → Universal inputs → Universal input x → Comparison temp. Direct access code: 220014-0xx Examples: Universal input 1: 220014-000; Universal input 12: 220014-011
<b>Description</b>	Settings for the external comparison temperature (only when connecting thermocouples). Only visible if comparison point = External
<b>User entry</b>	0 to 9999999 (Depends on the temperature unit selected)
<b>Factory setting</b>	0 (Depends on the temperature unit selected)

---

## Totalizer

(Online configuration)



---

<b>Navigation</b>	 Expert → Inputs → Universal inputs → Universal input x → Totalizer Direct access code: 220015-0xx Examples: Universal input 1: 220015-000; Universal input 12: 220015-011
<b>Description</b>	Initial setting for the totalizer. Useful when continuing measurements recorded to date with an (electro)-mechanical counter. Only visible if signal = Pulse counter or counter for Modbus Master
<b>User entry</b>	Number (max. 15 digits)
<b>Factory setting</b>	0

---

## "Linearization" submenu

---

<b>Navigation</b>	 Expert → Inputs → Universal inputs → Universal input x → Linearization
<b>Description</b>	Contains settings for linearization.  Only current and voltage inputs can be linearized.

---

## Linearization

---

<b>Navigation</b>	 Expert → Inputs → Universal inputs → Universal input x → Linearization → Linearization Direct access code: 230000-0xx Examples: Universal input 1: 230000-000; Universal input 12: 230000-011
<b>Description</b>	Specify whether this analog input should be linearized.
<b>Selection</b>	No, Yes
<b>Factory setting</b>	No

---

## Number of points

---

<b>Navigation</b>	 Expert → Inputs → Universal inputs → Universal input x → Linearization → Number of points Direct access code: 230001-0xx Examples: Universal input 1: 230001-000; Universal input 12: 230001-011
-------------------	--

<b>Description</b>	Specify how many support points your linearization table has.  Note: The first and last point must always correspond to the start and end of the measuring range respectively.
<b>User entry</b>	2 to 32
<b>Factory setting</b>	2

---

#### Dim. linearized value

---

<b>Navigation</b>	 Expert → Inputs → Universal inputs → Universal input x → Linearization → Dim. linearized value Direct access code: 230002-0xx Examples: Universal input 1: 230002-000; Universal input 12: 230002-011
<b>Description</b>	Unit/dimension for the linearized value.
<b>User entry</b>	Text (max. 6 characters)

---

#### Zoom start

---

<b>Navigation</b>	 Expert → Inputs → Universal inputs → Universal input x → Linearization → Zoom start Direct access code: 230003-0xx Examples: Universal input 1: 230003-000; Universal input 12: 230003-011
<b>Description</b>	If the total transmitter range is not used, you can enter the lower value of the required section here (higher resolution). Example: Transmitter 0-14 pH, required section: 5-9 pH. Set "5" here. The zoom has no influence on the storage.
<b>User entry</b>	0 to 9999999
<b>Factory setting</b>	0

---

#### Zoom end

---

<b>Navigation</b>	 Expert → Inputs → Universal inputs → Universal input x → Linearization → Zoom end Direct access code: 230004-0xx Examples: Universal input 1: 230004-000; Universal input 12: 230004-011
<b>Description</b>	Like "Zoom start". Enter the upper value of the required range here. Example: Transmitter 0-14 pH, required section: 5-9 pH. Here: "9".
<b>User entry</b>	0 to 9999999
<b>Factory setting</b>	100

---

**Points**

---

**Navigation**  Expert → Inputs → Universal inputs → Universal input x → Linearization → Points

**Description** Enter the support points of the linearization table here.  
 Note: The first and last point must always correspond to the start and end of the measuring range respectively. The support points can only be viewed in the PC software here. To change the support points use the "Edit table" switch.

---

**Sort table**

---

**Navigation**  Expert → Inputs → Universal inputs → Universal input x → Linearization → Points → Sort table  
 Direct access code: 230020-0xx  
 Examples: Universal input 1: 230020-000; Universal input 12: 230020-011

**Description** You can sort the linearization table here.

**Selection** No, Yes

**Factory setting** No

---

**Check table**

---

**Navigation**  Expert → Inputs → Universal inputs → Universal input x → Linearization → Points → Check table  
 Direct access code: 230008-0xx  
 Examples: Universal input 1: 230008-000; Universal input 12: 230008-011

**Description** Here you can check whether the linearization table has been entered correctly.

**Selection** No, Yes

**Factory setting** No

---

**x-value (1 to 32)**

---

**Navigation**  Expert → Inputs → Universal inputs → Universal input x → Linearization → Points → x-value (1 to 32)  
 Direct access code, x-value 1: 230100-0xx  
 Direct access code, x-value 2: 230102-0xx  
 Examples: Universal input 1, x-value 1: 230100-000; Universal input 12, x-value 1: 230100-011

**Description** x-value for the linearization (value from the device input). e.g. 10 cm corresponds to 20 liters --> enter 10.

**User entry** 0 to 9999999

Factory setting 0

---

### y-value (1 to 32)

---

**Navigation**  Expert → Inputs → Universal inputs → Universal input x → Linearization → Points → y-value (1 to 32)  
 Direct access code, y-value 1: 230101-0xx  
 Direct access code, y-value 2: 230103-0xx  
 Examples: Universal input 1, y-value 1: 230101-000; Universal input 12, y-value 1: 230101-011

**Description** Enter the y-value that the measured x-value corresponds to e.g. 10 cm corresponds to 20 liters --> enter 20.

**User entry** 0 to 9999999

**Factory setting** 0

---

### "Meas.val. corrct." submenu

---

**Navigation**  Expert → Inputs → Universal inputs → Universal input x → Meas.val. corrct.

**Description** Determining the correction values to balance measurement tolerances.

**Proceed as follows:**

- Measure the current value at the lower measurement range.
- Measure the current value at the upper measurement range.
- Enter the lower and upper target and actual value.

---

### Offset

---

**Navigation**  Expert → Inputs → Universal inputs → Universal input x → Meas.val. corrct. → Offset  
 Direct access code: 220050-0xx  
 Examples: Universal input 1: 220050-000; Universal input 12: 220050-011

**Description** This offset is only effective on the analog input signal (no maths/bus channels).  
 Only visible if signal = Resistance thermometer or Thermocouple

**User entry** Number (max. 8 digits)

**Factory setting** 0

---

### Correction RPT

---

**Navigation**  Expert → Inputs → Universal inputs → Universal input x → Meas.val. correct. → Correction RPT  
Direct access code: 220057-0xx  
Examples: Universal input 1: 220057-000; Universal input 12: 220057-011

**Description** Rear panel temperature correction value for this analog input (only required for thermocouples).

 Only visible/editable if the service code has been entered.

**User entry** Number (max. 8 digits)

**Factory setting** -3.0 for slot 1+2  
-3.2 for slot 3  
-3.5 for slot 4+5

### Range start

### Target value

**Navigation**  Expert → Inputs → Universal inputs → Universal input x → Meas.val. correct. → Target value  
Direct access code: 220052-0xx  
Examples: Universal input 1: 220052-000; Universal input 12: 220052-011

**Description** Enter the lower set point here (e.g. measuring range 0°C to 100°C: 0°C).  
Only visible if signal = Current or Voltage

**User entry** Number (max. 8 digits)

**Factory setting** 0

### Actual value

**Navigation**  Expert → Inputs → Universal inputs → Universal input x → Meas.val. correct. → Actual value  
Direct access code: 220053-0xx  
Examples: Universal input 1: 220053-000; Universal input 12: 220053-011

**Description** Enter the lower value actually measured here (e.g. measuring range 0°C to 100°C: measured value 0.5°C).  
Only visible if signal = Current or Voltage

**User entry** Number (max. 8 digits)

**Factory setting** 0



---

**Meas. range end**



---



---

**Target value**



---

<b>Navigation</b>	 Expert → Inputs → Universal inputs → Universal input x → Meas.val. corrct. → Target value Direct access code: 220055-0xx Examples: Universal input 1: 220055-000; Universal input 12: 220055-011
<b>Description</b>	Enter the upper set point here (e.g. measuring range 0°C to 100°C: 100°C). Only visible if signal = Current or Voltage
<b>User entry</b>	Number (max. 8 digits)
<b>Factory setting</b>	100

---

**Actual value**



---

<b>Navigation</b>	 Expert → Inputs → Universal inputs → Universal input x → Meas.val. corrct. → Actual value Direct access code: 220056-0xx Examples: Universal input 1: 220056-000; Universal input 12: 220056-011
<b>Description</b>	Enter the upper value actually measured here (e.g. measuring range 0°C to 100°C: measured value 100.5°C). Only visible if signal = Current or Voltage
<b>User entry</b>	Number (max. 8 digits)
<b>Factory setting</b>	100

---

**"Totalization" submenu**



---

<b>Navigation</b>	 Expert → Inputs → Universal inputs → Universal input x → Totalization
<b>Description</b>	Set up only required for totalization of flow or power consumption.

---

**Totalization**

---

<b>Navigation</b>	 Expert → Inputs → Universal inputs → Universal input x → Totalization → Totalization Direct access code: 220030-0xx Examples: Universal input 1: 220030-000; Universal input 12: 220030-011
-------------------	---

<b>Description</b>	By totalizing the analog signal (e.g. flow rate in m <sup>3</sup> /h) quantities (in m <sup>3</sup> ) can be calculated.
<b>Selection</b>	No, Yes
<b>Factory setting</b>	No

---

### Totalization base

---

<b>Navigation</b>	 Expert → Inputs → Universal inputs → Universal input x → Totalization → Totalization base Direct access code: 220031-0xx Examples: Universal input 1: 220031-000; Universal input 12: 220031-011
<b>Description</b>	Select the required time base. Example: ml/s -> time base seconds (s); m <sup>3</sup> /h -> time base hours (h). Only visible if totalization = Yes
<b>Selection</b>	Second (s), Minute (min), Hour (h), Day (d)
<b>Factory setting</b>	Second (s)

---

### Unit

---

<b>Navigation</b>	 Expert → Inputs → Universal inputs → Universal input x → Totalization → Unit Direct access code: 220032-0xx Examples: Universal input 1: 220032-000; Universal input 12: 220032-011
<b>Description</b>	Enter the unit for the calculated quantity (e.g. "m <sup>3</sup> "). Only visible if totalization = Yes
<b>User entry</b>	Text (max. 6 characters)

---

### Low flow cut off

---

<b>Navigation</b>	 Expert → Inputs → Universal inputs → Universal input x → Totalization → Low flow cut off Direct access code: 220033-0xx Examples: Universal input 1: 220033-000; Universal input 12: 220033-011
<b>Description</b>	If the volume flow recorded is below the set value, these quantities are not added to the counter. If the input is scaled from 0 to y, or if the pulse input is used, all values that are smaller than the set value are not recorded. If the input is scaled from -x to +y, all values around the zero point (e.g. also negative values) are not recorded. Only visible if totalization = Yes

**User entry** Number (max. 8 digits)

**Factory setting** 0

---

### Calc. factor

---

**Navigation**  Expert → Inputs → Universal inputs → Universal input x → Totalization → Calc. factor  
Direct access code: 220034-0xx  
Examples: Universal input 1: 220034-000; Universal input 12: 220034-011

**Description** Factor for calculating the integrated value (e.g. the transmitter delivers l/s → totalization base = second → engineering unit required is m<sup>3</sup> → enter factor 0.001)  
Only visible if totalization = Yes

**User entry** Number (max. 8 digits)

**Factory setting** 1.0

---

### Totalizer (Online configuration)

---

**Navigation**  Expert → Inputs → Universal inputs → Universal input x → Totalization → Totalizer  
Direct access code: 220035-0xx  
Examples: Universal input 1: 220035-000; Universal input 12: 220035-011

**Description** Initial setting for the totalizer. Useful when continuing measurements recorded to date with an (electro)-mechanical counter.  
Only visible if totalization = Yes

**User entry** Number (max. 15 digits)

**Factory setting** 0

---

### "Fault mode" submenu

---

 In the event of an error the alarm relay is switched if so configured →  131

**Navigation**  Expert → Inputs → Universal inputs → Universal input x → Fault mode

**Description** Contains settings that define how this channel is to react under fault conditions (e.g. cable open circuit, over range).

---

### NAMUR NE 43

---

**Navigation**  Expert → Inputs → Universal inputs → Universal input x → Fault mode → NAMUR NE 43  
Direct access code: 220060-0xx  
Examples: Universal input 1: 220060-000; Universal input 12: 220060-011

**Description** Activate/deactivate the 4-20mA loop monitoring as per NAMUR recommendation NE 43. The following error ranges apply when NAMUR NE43 is switched on:  
≤ 3.8 mA: under range  
≥ 20.5 mA: over range  
≤ 3.6 mA or ≥ 21.0 mA: sensor error  
≤ 2 mA: cable open circuit  
Only visible if signal = "Current" and range = "4-20 mA" or "4-20 mA squared".

**Selection** Off, On

**Factory setting** On

---

### Cable open circuit

---

**Navigation**  Expert → Inputs → Universal inputs → Universal input x → Fault mode → Cable open circuit  
Direct access code: 220060-0xx  
Examples: Universal input 1: 220060-000; Universal input 12: 220060-011

**Description** Cable open circuit detection  
Only visible if signal = "Voltage" and range = "1-5 V" or "1-5 V squared".

**Selection** Off, On

**Factory setting** On

---

### Lower error value

---

**Navigation**  Expert → Inputs → Universal inputs → Universal input x → Fault mode → Lower error value  
Direct access code: 220065-0xx  
Examples: Universal input 1: 220065-000; Universal input 12: 220065-011

**Description** When NE43 is switched off, defines the value that must be undershot for the device to output an error.  
Only visible if signal = "Current", range = "4-20 mA" and NAMUR NE 43 = "Off"

**User entry** Number (max. 8 digits); 0 to 4 mA

**Factory setting** 3.9mA

---

### Upper error value



---

<b>Navigation</b>	 Expert → Inputs → Universal inputs → Universal input x → Fault mode → Upper error value Direct access code: 220066-0xx Examples: Universal input 1: 220066-000; Universal input 12: 220066-011
<b>Description</b>	When NE43 is switched off, defines the value that must be exceeded for the device to output an error. Only visible if signal = "Current", range = "4-20 mA" and NAMUR NE 43 = "Off"
<b>User entry</b>	Number (max. 8 digits); 20 to 22mA
<b>Factory setting</b>	20.8mA

**Time delay**

<b>Navigation</b>	 Expert → Inputs → Universal inputs → Universal input x → Fault mode → Time delay Direct access code: 220064-0xx Examples: Universal input 1: 220064-000; Universal input 12: 220064-011
<b>Description</b>	The device only reacts (e.g. relay switch) when this condition, open circuit/under range/over range, has been operational for the preset time. Only visible if NAMUR NE 43 = On
<b>User entry</b>	0 to 99 s
<b>Factory setting</b>	0s

**On error**

<b>Navigation</b>	 Expert → Inputs → Universal inputs → Universal input x → Fault mode → On error Direct access code: 220061-0xx Examples: Universal input 1: 220061-000; Universal input 12: 220061-011
<b>Description</b>	Configure what value the device should continue working with (for calculations) if the measured value is not valid (e.g. cable open circuit).  In the event of an error value, all the dependent calculations are flagged accordingly as "error value". Counters are not flagged, however!
<b>Selection</b>	Invalid calculation, Error value
<b>Factory setting</b>	Invalid calculation

**Error value**

<b>Navigation</b>	 Expert → Inputs → Universal inputs → Universal input x → Fault mode → Error value Direct access code: 220062-0xx Examples: Universal input 1: 220062-000; Universal input 12: 220062-011
<b>Description</b>	The device continues calculating with this value in the event of an error. Only visible if on error = Error value
<b>User entry</b>	Number (max. 8 digits)
<b>Factory setting</b>	0

---

### Save event

---

<b>Navigation</b>	 Expert → Inputs → Universal inputs → Universal input x → Fault mode → Save event Direct access code: 220063-0xx Examples: Universal input 1: 220063-000; Universal input 12: 220063-011
<b>Description</b>	Stores a message in the event log when a fault occurs.
<b>Selection</b>	No, Yes
<b>Factory setting</b>	No

---

### Copy settings



---

<b>Navigation</b>	 Expert → Inputs → Universal inputs → Universal input x → Copy settings Direct access code: 220200-0xx Examples: Universal input 1: 220200-000; Universal input 12: 220200-011
<b>Description</b>	Copies settings from actual channel to selected channel.
<b>Selection</b>	Switched off, Universal input x Users can choose from all the available universal inputs.
<b>Factory setting</b>	Switched off

---

### "Digital inputs -> Digital input x" submenu

---

<b>Navigation</b>	 Expert → Inputs → Digital inputs → Digital input x
<b>Description</b>	Setting up only required if the digital inputs (e.g. events) are to be used.  x = place holder for selected digital input

---

### Add input

---

<b>Navigation</b>	 Expert → System → Digital inputs → Add input Direct access code: 252000/000
<b>Description</b>	Addition of a digital input that must be configured according to the function.
<b>Selection</b>	No, Digital input x
<b>Factory setting</b>	No

**Delete input**

<b>Navigation</b>	 Expert → System → Digital inputs → Delete input Direct access code: 252001/000
<b>Description</b>	Delete an input configuration.
<b>Selection</b>	No, Digital input x
<b>Factory setting</b>	No

**Function**

<b>Navigation</b>	 Expert → Inputs → Digital inputs → Digital input x → Function Direct access code: 250000-00x Examples: Digital input 1: 250000-000; Digital input 6: 250000-005
<b>Description</b>	Select the required function. Digital inputs are High active; this means the described effect is achieved by a high input. Low = -3 to +5 V High = +12 to +30 V
<b>Selection</b>	Switched off, Control input, On/off event, Pulse counter, Operational time, Event + operation time, Quantity from time, Profibus DP (option), Modbus slave (option), EtherNet/IP (option), PROFINET (option)
<b>Factory setting</b>	Switched off

**Function**

<b>Navigation</b>	 Expert → Inputs → Digital inputs → Digital input x → Function Direct access code: 250014-00x Examples: Digital input 1: 250014-000; Digital input 6: 250014-005
<b>Description</b>	Specifies how the data from the fieldbus is interpreted/processed. Visible only if function = Profibus DP, Modbus slave, EtherNet/IP, PROFINET

**Selection** Switched off, Control input, On/off event, Pulse counter, Operational time, Event + operation time, Quantity from time

**Factory setting** Switched off

---

### Channel ident.

---

**Navigation**  Expert → Inputs → Digital inputs → Digital input x → Channel ident.  
Direct access code: 250001-00x  
Examples: Digital input 1: 250001-000; Digital input 6: 250001-005

**Description** Measurement point name (e.g. "Pump") or description of the function of this input (e.g. "Fault message").  
Only visible if function ≠ Switched off

**User entry** Text (max. 16 characters)

**Factory setting** Digital x

---

### Engineering unit

---

**Navigation**  Expert → Inputs → Digital inputs → Digital input x → Engineering unit  
Direct access code: 250002-00x  
Examples: Digital input 1: 250002-000; Digital input 6: 250002-005

**Description** Technical unit of the count input, e.g. gal, cf, ... .  
Only visible if function = Pulse counter or Quantity from time

**User entry** Text (max. 6 characters)

---

### Decimal point

---

**Navigation**  Expert → Inputs → Digital inputs → Digital input x → Decimal point  
Direct access code: 250004-00x  
Examples: Digital input 1: 250004-000; Digital input 6: 250004-005

**Description** Number of places after decimal point for the display.  
Only visible if function = Pulse counter or Quantity from time

**Selection** None, One (X.Y), Two (X.YY), Three (X.YYY), Four (X.YYYY), Five (X.YYYYY)

**Factory setting** One (X.Y)



**Input factor in**

<b>Navigation</b>	 Expert → Inputs → Digital inputs → Digital input x → Input factor in Direct access code: 250019-00x Examples: Digital input 1: 250019-000; Digital input 6: 250019-005
<b>Description</b>	Defines if the set up factor is respective to 1 second or 1 hour. Only visible if function = Quantity from time
<b>Selection</b>	Seconds, Hours
<b>Factory setting</b>	Seconds

**Pulse value**

<b>Navigation</b>	 Expert → Inputs → Digital inputs → Digital input x → Pulse value Direct access code: 250005-00x Examples: Digital input 1: 250005-000; Digital input 6: 250005-005
<b>Description</b>	Factor, that when multiplied by the input signal results in the required physical value. Examples: 1 pulse equals 5 m <sup>3</sup> -> enter "5" here. Only visible if function = Pulse counter
<b>User entry</b>	Number (max. 8 digits)
<b>Factory setting</b>	1

**1 second=/1 hour=** (depends on the setting in "Input factor in")

<b>Navigation</b>	 Expert → Inputs → Digital inputs → Digital input x → 1 second= / 1 hour= Direct access code: 250005-00x Examples: Digital input 1: 250005-000; Digital input 6: 250005-005
<b>Description</b>	Factor, that when multiplied by the operating time results in the required physical value. Examples: 1 second equals 8 l -> enter "8" here. Only visible if function = Quantity from time
<b>User entry</b>	Number (max. 8 digits)
<b>Factory setting</b>	1

**Time delay**

**Navigation**

 Expert → Inputs → Digital inputs → Digital input x → Time delay  
 Direct access code: 250017-00x  
 Examples: Digital input 1: 250017-000; Digital input 6: 250017-005

**Description**

The high signal must be active for at least the preset time before the device changes the channel from low to high.  
 The change from high to low is always immediate.  
 Only visible if function = Control input, On/off event, Event+operation time

**User entry**

0 to 99 999 s

**Factory setting**



0

**Action****Navigation**

 Expert → Inputs → Digital inputs → Digital input x → Action  
 Direct access code: 250003-00x  
 Examples: Digital input 1: 250003-000; Digital input 6: 250003-005

**Description**

Set up the function of the control input.  
 Only visible if function = Control input

Action	Description
Start/stop recording	The device only saves data as long as a high signal is present
Screensaver on	Switches backlighting/display off, low = off, high = on  This function is <b>not</b> supported by the <b>DIN rail version</b> .
Lock setup	The user can only change the setup if a low signal is present
Time synchronization	If a high signal is applied, the device rounds the system time up or down (only for Low→High change): 0 to 29 → round down; 30 to 59 → round up
Change group (panel-mounted device only)	The display switches to the next active group in the event of a Low→High change.
Set point monitoring on/off	The entire set point monitoring function of the device can be switched on (for "High") or switched off (for "Low").
Individual LV on/off	Monitoring for a selected limit value can be switched on (for "High") or switched off (for "Low").
Block keyboard/navigator	The device can only be operated if a low signal is present. Otherwise all key activation and navigator actions are discarded.  This function is <b>not</b> supported by the <b>DIN rail version</b> .
Start/stop analysis 1-4	Starts/ends one of the max. 4 external analyses (the analysis runs only as long as the signal is high). Measured value acquisition for the graphic display continues. Batches are also started/ended with this function. Note: This function is not available in the case of batch and control input via a maths channel.
Reset batch number x (option)	Resets the automatically generated batch number (1..x) to 0 (in the event of a LowHigh change).
Batch x limit values on/off (option)	Switches the limits of batch x on/off. The limits relating to the batch are determined based on the group settings (via the channels assigned to the batch). If a channel is assigned to several batches, the limits for this channel are not disabled.

**Selection** Switched off, Start/stop recording, Screensaver on, Lock setup, Time synchronization, Change group, Set point monitoring on/off, Individual LV on/off, Block keyboard/navigator, Start/stop analysis x, Reset batch no. x, Batch x limits on/off

**Factory setting** Switched off

---

## Group

---

**Navigation**  Expert → Inputs → Digital inputs → Digital input x → Group  
Direct access code: 250015-00x  
Examples: Digital input 1: 250015-000; Digital input 6: 250015-005

**Description** Choose the group which should be displayed in the event of a change from Low->High. Alternatively the next active group can be displayed.  
Only visible if function = Control input and action = Change group

**Selection** Change automatically, Group x

**Factory setting** Change automatically

---

## Set point

---

**Navigation**  Expert → Inputs → Digital inputs → Digital input x → Set point  
Direct access code: 250016-00x  
Examples: Digital input 1: 250016-000; Digital input 6: 250016-005

**Description** Select the set point which should be switched on or off by means of this control input.  
Only visible if function = Control input and action = Individual LV on/off

**Selection** Switched off, Universal input xx, Digital input xx, Math xx, Limit xx, Relay xx

**Factory setting** Change automatically

---

## Switches relay

---

**Navigation**  Expert → Inputs → Digital inputs → Digital input x → Switches relay  
Direct access code: 250006-00x  
Examples: Digital input 1: 250006-000; Digital input 6: 250006-005

**Description** Switches the respective relay when the digital input is low or high. Please take note of the connection hints in the operating manual!  
Only visible if function = Control input, On/off event, Event+operation time

**Selection** Not used, Relay x  
All the available relays are displayed.

**Factory setting** Not used

---

### Description 'H'

---

**Navigation**  Expert → Inputs → Digital inputs → Digital input x → Description 'H'  
Direct access code: 250007-00x  
Examples: Digital input 1: 250007-000; Digital input 6: 250007-005

**Description** Condition description when the digital input is active. This text is both shown on the display and saved to memory.  
Only visible if function = Control input, On/off event, Event+operation time

**User entry** Text (max. 6 characters)

**Factory setting** On

---

### Description 'L'

---

**Navigation**  Expert → Inputs → Digital inputs → Digital input x → Description 'L'  
Direct access code: 250008-00x  
Examples: Digital input 1: 250008-000; Digital input 6: 250008-005

**Description** Condition description when the digital input is not active. This text is both shown on the display and saved to memory.  
Only visible if function = Control input, On/off event, Event+operation time

**User entry** Text (max. 6 characters)

**Factory setting** Off

---

### Save event

---

**Navigation**  Expert → Inputs → Digital inputs → Digital input x → Save event  
Direct access code: 250009-00x  
Examples: Digital input 1: 250009-000; Digital input 6: 250009-005

**Description** Determines whether the condition change from low to high or high to low is stored in the event log.

 Requires higher memory capacity.

Only visible if function = Control input, On/off event, Event+operation time



**Selection** No, Yes, only "On" message

**Factory setting** Yes

---

**Event message**



---

<b>Navigation</b>	 Expert → Inputs → Digital inputs → Digital input x → Event message Direct access code: 250018-00x Examples: Digital input 1: 250018-000; Digital input 6: 250018-005
<b>Description</b>	"Do not acknowledge": No message is shown if the digital input switches. "Acknowledge": A message window is shown on the screen which has to be acknowledged by operating a push button. Only visible if function = Control input, On/off event, Event+operation time  In the case of the DIN rail version, the message can only be acknowledged via the Web server!
<b>Selection</b>	Do not acknowledge, Acknowledge
<b>Factory setting</b>	Do not acknowledge

---

**Event text L->H**



---

<b>Navigation</b>	 Expert → Inputs → Digital inputs → Digital input x → Event text L->H Direct access code: 250010-00x Examples: Digital input 1: 250010-000; Digital input 6: 250010-005
<b>Description</b>	Description of condition change from low to high. Event text is stored (e.g. Start filling).  If no event text is set, the device generates an automatic event text (factory setting), e.g. digital 1 L->H. Only visible if function = Control input, On/off event, Event+operation time
<b>User entry</b>	Text (max. 22 characters)

---

**Event text H->L**



---

<b>Navigation</b>	 Expert → Inputs → Digital inputs → Digital input x → Event text H->L Direct access code: 250011-00x Examples: Digital input 1: 250011-000; Digital input 6: 250011-005
<b>Description</b>	Description of condition change from high to low. Event text is stored (e.g. Stop filling).  If no event text is set, the device generates an automatic event text (factory setting), e.g. digital 1 H->L. Only visible if function = Control input, On/off event, Event+operation time
<b>User entry</b>	Text (max. 22 characters)

---

**Record duration**



---

<b>Navigation</b>	 Expert → Inputs → Digital inputs → Digital input x → Record duration Direct access code: 250012-00x Examples: Digital input 1: 250012-000; Digital input 6: 250012-005
<b>Description</b>	The duration between "On" and "Off" can be recorded. The duration is appended to the "Off" event text (<hhhh>h<mm>:<ss>). Power failure times do not affect the duration. If the digital channel was "on" before the power failure and is still "on" after the power failure, the duration continues. Only visible if function = Control input, On/off event, Event+operation time
<b>Selection</b>	No, Yes
<b>Factory setting</b>	No

---

**Totalizer**  
(Online configuration)

---

<b>Navigation</b>	 Expert → Inputs → Digital inputs → Digital input x → Totalizer Direct access code: 250013-00x Examples: Digital input 1: 250013-000; Digital input 6: 250013-005
<b>Description</b>	Initial setting for the totalizer. Useful when continuing measurements recorded to date with an (electro)-mechanical counter. Only visible if function = Pulse counter, Operational time, Event+operation time or Quantity from time
<b>User entry</b>	Number (max. 15 digits)
<b>Factory setting</b>	0

---

**Copy settings**

---

<b>Navigation</b>	 Expert → Inputs → Digital inputs → Digital input x → Copy settings Direct access code: 250200-00x Examples: Digital input 1: 250200-000; Digital input 6: 250200-005
<b>Description</b>	Copies settings from actual channel to selected channel.
<b>Selection</b>	No, Digital input x Users can choose from all the available digital inputs.
<b>Factory setting</b>	No

### 17.1.3 "Outputs" submenu

Setting up only required if outputs (e.g. relays) are to be used.

---

#### "Universal output x" submenu

---

<b>Navigation</b>	 Expert → Outputs → Universal output x
<b>Description</b>	Settings for the universal output selected (current or pulse output).

---

#### Signal

---

<b>Navigation</b>	 Expert → Outputs → Universal output x → Signal Direct access code: 340000-00x Examples: Universal output 1: 340000-000; Universal output 2: 340000-001
<b>Description</b>	Select the output signal for this channel.
<b>Selection</b>	Switched off, 4-20 mA, 0-20 mA, Pulse output
<b>Factory setting</b>	Switched off

---

#### Reference channel

---

<b>Navigation</b>	 Expert → Outputs → Universal output x → Reference channel Direct access code: 340001-00x Examples: Universal output 1: 340001-000; Universal output 2: 340001-001
<b>Description</b>	Select the input to which the analog output refers.
<b>Selection</b>	Switched off, Universal input x, Digital input x, Maths x, Limit x, Relay x All active inputs are available for selection.
<b>Factory setting</b>	Switched off

---

#### Start value

---

<b>Navigation</b>	 Expert → Outputs → Universal output x → Start value Direct access code: 340003-00x Examples: Universal output 1: 340003-000; Universal output 2: 340003-001
<b>Description</b>	Configure what value corresponds to 0/4 mA. Only visible if signal = 4-20 mA or 0-20 mA.
<b>User entry</b>	Number (max. 8 characters)

**Factory setting** 0

---

### Full scale value

---

**Navigation**  Expert → Outputs → Universal output x → Full scale value  
 Direct access code: 340004-00x  
 Examples: Universal output 1: 340004-000; Universal output 2: 340004-001

**Description** Configure what value corresponds to 20 mA.  
 Only visible if signal = 4-20 mA or 0-20 mA.

**User entry** Number (max. 8 characters)

**Factory setting** 100

---

### Damping/filter

---

**Navigation**  Expert → Outputs → Universal output x → Damping/filter  
 Direct access code: 340005-00x  
 Examples: Universal output 1: 340005-000; Universal output 2: 340005-001

**Description** Time constant of the first order low pass for the output signal. This is used to prevent strong fluctuations of the output signal.  
 Only visible if signal = 4-20 mA or 0-20 mA.

**User entry** 0 to 999.9 s

**Factory setting** 0.0 s

---

### Pulse value

---

**Navigation**  Expert → Outputs → Universal output x → Pulse value  
 Direct access code: 340006-00x  
 Examples: Universal output 1: 340006-000; Universal output 2: 340006-001

**Description** The pulse value specifies what quantity an output pulse corresponds to (e.g. 1 pulse = 5 liters).  
 Only visible if signal = Pulse output

**User entry** Number (min. 0.000001; max. 8 characters)

**Factory setting** 1



**Pulse width**

<b>Navigation</b>	 Expert → Outputs → Universal output x → Pulse width Direct access code: 340007-00x Examples: Universal output 1: 340007-000; Universal output 2: 340007-001
<b>Description</b>	The pulse width limits the maximum possible output frequency of the pulse output. Define a fixed or dynamic pulse width. Only visible if signal = Pulse output
<b>Selection</b>	User-defined, Dynamic (max. 1000ms)
<b>Factory setting</b>	User-defined

**Pulse width**

<b>Navigation</b>	 Expert → Outputs → Universal output x → Pulse width Direct access code: 340008-00x Examples: Universal output 1: 340008-000; Universal output 2: 340008-001
<b>Description</b>	You can set the pulse width in the range from 0.5 to 1000 ms here. Only visible if signal = Pulse output
<b>Value</b>	0.5 to 1000 ms
<b>Factory setting</b>	100 ms

**"Meas.val. corrct." submenu**

<b>Navigation</b>	 Expert → Outputs → Universal output x → Meas.val. corrct.
<b>Description</b>	Here, you can correct the output current value (necessary only if the device that carries out the further processing cannot compensate for any measurement section tolerances). Proceed as follows: 1. On the connected device, read out the displayed value in both the upper and lower measuring range. 2. Enter the lower and upper target and actual value. Only visible if signal = 4-20 mA or 0-20 mA.

**Lower correction value**

**Target value**

---

**Navigation**  Expert → Outputs → Universal output x → Meas.val. corrct. → Lower correction value → Target value  
Direct access code: 340021-00x  
Examples: Universal output 1: 340021-000; Universal output 2: 340021-001

**Description** Enter the lower set point here.  
Only visible if signal = 4-20 mA or 0-20 mA.

**User entry** Number (max. 8 characters)

**Factory setting** 0

---

### Actual value

---

**Navigation**  Expert → Outputs → Universal output x → Meas.val. corrct. → Lower correction value → Actual value  
Direct access code: 340022-00x  
Examples: Universal output 1: 340022-000; Universal output 2: 340022-001

**Description** Here, enter the lower actual value which is displayed at the connected device.  
Only visible if signal = 4-20 mA or 0-20 mA.

**User entry** Number (max. 8 characters)

**Factory setting** 0

---

### Upper correction value

---

### Target value

---

**Navigation**  Expert → Outputs → Universal output x → Meas.val. corrct. → Upper correction value → Target value  
Direct access code: 340024-00x  
Examples: Universal output 1: 340024-000; Universal output 2: 340024-001

**Description** Enter the upper set point here.  
Only visible if signal = 4-20 mA or 0-20 mA.

**User entry** Number (max. 8 characters)

**Factory setting** 100

---

### Actual value

---

**Navigation**  Expert → Outputs → Universal output x → Meas.val. corrct. → Upper correction value → Actual value  
Direct access code: 340025-00x  
Examples: Universal output 1: 340025-000; Universal output 2: 340025-001

**Description** Here, enter the upper actual value which is displayed at the connected device.  
Only visible if signal = 4-20 mA or 0-20 mA.

**User entry** Number (max. 8 characters)

**Factory setting** 100

---

#### "Fault mode" submenu

---

**Navigation**  Expert → Outputs → Universal output x → Fault mode

**Description** Configure how the analog output should behave in the event of an error (e.g. if the input channel has a cable open circuit).  
Only visible if signal = 4-20 mA or 0-20 mA.

---

#### NAMUR NE 43

---

**Navigation**  Expert → Outputs → Universal output x → Fault mode → NAMUR NE 43  
Direct access code: 340015-00x  
Examples: Universal output 1: 340015-000; Universal output 2: 340015-001

**Description** Activate/deactivate the 4-20 mA loop output as per NAMUR recommendation NE 43. The following error ranges apply when NAMUR NE43 is switched on:  
≤3.8 mA: underrange  
≥20.5 mA: overrange  
≤ 3.6 mA or ≥ 21.0 mA: cable open circuit  
Only visible if signal = 4-20 mA or 0-20 mA.

**Selection** Off, On

**Factory setting** On

---

#### On error

---

**Navigation**  Expert → Outputs → Universal output x → Fault mode → On error  
Direct access code: 340016-00x  
Examples: Universal output 1: 340016-000; Universal output 2: 340016-001

**Description** What value should the output adopt in the event of an error (e.g. cable break or calculated value invalid)?  
Only visible if signal = 4-20 mA or 0-20 mA.

**Selection** Invalid calculation, Error value

**Factory setting** Invalid calculation

---

#### Error value



---

<b>Navigation</b>	 Expert → Outputs → Universal output x → Fault mode → Error value Direct access code: 340017-00x Examples: Universal output 1: 340017-000; Universal output 2: 340017-001
<b>Description</b>	This value is output in the event of an error. Note: Must be between 0 and 22 mA. Only visible if signal = 4-20 mA or 0-20 mA.
<b>User entry</b>	0 to 22 mA
<b>Factory setting</b>	0 mA

---

### "Relay x" submenu

---

<b>Navigation</b>	 Expert → Outputs → Relay x
<b>Description</b>	Contains setup for the selected relay  x = place holder for selected relay

---

### Operating mode

---

<b>Navigation</b>	 Expert → Outputs → Relay x → Operating mode Direct access code: 330000-00x Examples: Relay 1:330000-000; Relay 6: 330000-005
<b>Description</b>	Relay function: NC contact: The relay is closed in its quiescent state (maximum safety). NO contact: The relay is open in its quiescent state.
<b>Selection</b>	NO contact, NC contact
<b>Factory setting</b>	NO contact

---

### Identifier

---

<b>Navigation</b>	 Expert → Outputs → Relay x → Identifier Direct access code: 330001-00x Examples: Relay 1:330001-000; Relay 6: 330001-005
<b>Description</b>	Pre-settable relay identifier.
<b>User entry</b>	Text (max. 16 characters)
<b>Factory setting</b>	Relay x

---

### Remote controlled

---

<b>Navigation</b>	 Expert → Outputs → Relay x → Remote controlled Direct access code: 330002-00x Examples: Relay 1:330002-000; Relay 6: 330002-005
<b>Description</b>	Configure whether the relay may be controlled remotely (e.g. PC or SMS). Only visible with the "Telealarm" option.
<b>Selection</b>	No, Yes
<b>Factory setting</b>	No

#### 17.1.4 "Communication" submenu

Set-up required if you are using the USB, RS232, RS485 or Ethernet interface of the unit (PC operation, serial data read-out, modem operation, etc.).

 The various interfaces can be operated in parallel.

---

#### Timeout cycl. readout

---

<b>Navigation</b>	 Expert → Communication → Timeout Direct access code: 150200-000
<b>Description</b>	Monitors whether measured values are read out cyclically via OPC or Fieldbus. Timeout is modifiable between 1 and 99 seconds. 0 seconds means that the functionality is inactivated.
<b>User entry</b>	0 to 99 s
<b>Factory setting</b>	0 s

---

#### Switches

---

<b>Navigation</b>	 Expert → Communication → Switches Direct access code: 150201-000
<b>Description</b>	After the given timeout the dedicated relay/OC is active while no readout of actual measured values are in process.
<b>Selection</b>	Not used, Relay x All the available relays are displayed.
<b>Factory setting</b>	Not used

---

#### Timeout fieldbus

---

<b>Navigation</b>	 Expert → Communication → Timeout fieldbus Direct access code: 150210-000
<b>Description</b>	Time within which measured values must be received via fieldbus (otherwise an error will be set). Not relevant if only measured values are read out.
<b>User entry</b>	1 to 99s
<b>Factory setting</b>	10 s

---

### Function USB-B

 This function is **not** supported by the **DIN rail version**.

---

<b>Navigation</b>	 Expert → Communication → Function USB-B Direct access code: 012001-000
<b>Description</b>	Determines the operating mode of the USB interface if a cable is connected to the device.
<b>Selection</b>	Always USB Always Ethernet over USB By user input
<b>Factory setting</b>	Always USB

---

### "Ethernet" submenu

<b>Navigation</b>	 Expert → Communication → Ethernet
<b>Description</b>	Contains the set-up required if you are using the Ethernet interface of the unit.

---

### MAC address (Online configuration)

<b>Navigation</b>	 Expert → Communication → Ethernet → MAC address Direct access code: 150000-000
<b>Description</b>	Displays the MAC address

---

### DHCP

<b>Navigation</b>	 Expert → Communication → Ethernet → DHCP Direct access code: 150002-000
-------------------	--

<b>Description</b>	The device can get its Ethernet settings through DHCP. Caution: The settings determined are not displayed until after setup acceptance!  Note: The unit always gets the same IP address if the leasing time is set long enough on the DHCP server. The PC software needs the IP address determined to establish a connection!
<b>Selection</b>	No, Yes
<b>Factory setting</b>	Yes

---

**IP address**



---

<b>Navigation</b>	 Expert → Communication → Ethernet → IP address Direct access code: 150003-000
<b>Description</b>	Please enter the IP address. (given from your network administrator). Can only be edited if DHCP = No
<b>User entry</b>	IP address
<b>Factory setting</b>	000.000.000.000

---

**Subnetmask**



---

<b>Navigation</b>	 Expert → Communication → Ethernet → Subnetmask Direct access code: 150004-000
<b>Description</b>	Please enter the subnetmask (given from your network administrator). Can only be edited if DHCP = No
<b>User entry</b>	IP address
<b>Factory setting</b>	255.255.255.000

---

**Gateway**



---

<b>Navigation</b>	 Expert → Communication → Ethernet → Gateway Direct access code: 150005-000
<b>Description</b>	Please enter the gateway (given from your network administrator). Can only be edited if DHCP = No
<b>User entry</b>	IP address
<b>Factory setting</b>	000.000.000.000

---

**Domain Name System (DNS)**



---

<b>Navigation</b>	 Expert → Communication → Ethernet → Domain Name System (DNS) Direct access code: 150009-000
<b>Description</b>	Please enter the IP-address of the DNS server (you can get this from your network administrator). Is needed if you wish to send e-mails and want to use the e-mail server name instead of the IP address (e.g. smtp.example.org). Can only be edited if DHCP = No
<b>User entry</b>	IP address
<b>Factory setting</b>	000.000.000.000

---

**Disable port**



---

<b>Navigation</b>	 Expert → Communication → Ethernet → Disable port Direct access code: 150020-000
<b>Description</b>	You can disable unused ports for security reasons. CDI is the protocol that the configuration software or reporting software uses to communicate with the device.  All other ports (e.g. SNTP, SMTP, Web server) are automatically disabled if the function is switched off.
<b>Selection</b>	CDI, OPC, Modbus Slave, HART IP
<b>Factory setting</b>	---- (no port disabled)

---

**Port**

---



<b>Navigation</b>	 Expert → Communication → Ethernet → Port Direct access code: 150001-000
<b>Description</b>	The system communicates with the PC software through this communication port.  If your network is protected by a firewall, this port may have to be enabled. Please contact your network administrator if this is the case.
<b>User entry</b>	Number (max. 5 digits)
<b>Factory setting</b>	8000



---

**OPC port**





---

<b>Navigation</b>	 Expert → Communication → Ethernet → OPC port Direct access code: 150010-000
<b>Description</b>	Values can be read via OPC server using this communication port.  If your network is protected by a firewall, this port may have to be enabled. Please contact your network administrator if this is the case.
<b>User entry</b>	Number (max. 5 digits)
<b>Factory setting</b>	8002

---

**HART IP port**



---

<b>Navigation</b>	 Expert → Communication → Ethernet → HART IP port Direct access code: 150030-000
<b>Description</b>	Connected HART devices can be accessed via this communication port using the communication device type manager (DTM). Only visible if a HART card is present.  Note: If your network is protected by a firewall, this port will have to be enabled. Please contact your network administrator if this is the case.  The "RSG45 HART CommDTM" is required in order to access connected HART devices via the RSG45. This establishes the connection between an FDT Frame application and a HART device. The DTM for the connected device must also be installed in the FDT Frame application. The "RSG45 HART CommDTM" is available via <a href="http://www.endress.com/rsg45">www.endress.com/rsg45</a> . Additional information →  42
<b>User entry</b>	Number (max. 5 digits)
<b>Factory setting</b>	5094

---

**Web server**



---

<b>Navigation</b>	 Expert → Communication → Ethernet → Web server Direct access code: 470000-000
<b>Description</b>	Switch the Web server function on or off. The instantaneous values can only be displayed using an Internet browser when the web browser is activated.  It is only possible to connect to the Web server via the Ethernet interface!
<b>Selection</b>	No (Web server is off), Yes (Web server is active)
<b>Factory setting</b>	Yes

---

**"Configuration Web server" submenu**



---

<b>Navigation</b>	 Expert → Communication → Ethernet → Configuration Web server
<b>Description</b>	Configure the Web server or specify which functionality should be possible via Web server. Only visible if Web server = Yes.
	 Instantaneous value display is always possible once the Web server is switched on.

---

**Port**



---

<b>Navigation</b>	 Expert → Communication → Ethernet → Configuration Web server → Port Direct access code: 470003-000
<b>Description</b>	The Web server communicates through this communication port.  If your network is protected by a firewall, this port may have to be enabled. Please contact your network administrator if this is the case.
<b>User entry</b>	Number (max. 5 digits)
<b>Factory setting</b>	80

---

**Setup**



---

<b>Navigation</b>	 Expert → Communication → Ethernet → Configuration Web server → Setup Direct access code: 470001-000
<b>Description</b>	The device can be configured via Web server. For security reasons it is advisable to switch off configuration via the Web server after commissioning. With regard to IT security please contact your network administrator if necessary.
<b>Selection</b>	No, Yes
<b>Factory setting</b>	Yes

---

**Firmware update**

---

<b>Navigation</b>	 Expert → Communication → Ethernet → Configuration Web server → Firmware update Direct access code: 470002-000
<b>Description</b>	Firmware can be updated via Web server.

**Selection** No, Yes

**Factory setting** No

---

### Remote control

 This function is **not** supported by the **DIN rail version**.

**Navigation**  Expert → Communication → Ethernet → Configuration Web server → Remote control  
Direct access code: 470004-000

**Description** The device can be remote-controlled via the Web server.

**Selection** No, Yes

**Factory setting** No

---

### WebDAV server

**Navigation**  Expert → Communication → Ethernet → Configuration Web server → WebDAV server  
Direct access code: 470006-000

**Description** The SD card can be read out via the WebDAV client.

**Selection** No, Yes

**Factory setting** No

---

### Batch (option)

**Navigation**  Expert → Communication → Ethernet → Configuration Web server → Batch  
Direct access code: 470007-000

**Description** Batches can be controlled via the Web server.

 Detailed descriptions of this device option can be found in the associated documentation.



**Selection** No, Yes

**Factory setting** No

---

**Control relays (option)**



---

<b>Navigation</b>	 Expert → Communication → Ethernet → Configuration Web server → Control relays Direct access code: 470008-000
<b>Description</b>	Relays can be remote-controlled via the Web server.  Detailed descriptions of this device option can be found in the associated documentation.
<b>Selection</b>	No, Yes
<b>Factory setting</b>	No

---

**Meas. val. without login**



---

<b>Navigation</b>	 Expert → Communication → Ethernet → Configuration Web server → Meas. val. without login Direct access code: 470009-000
<b>Description</b>	Allow access to current measured values without logging in. URL: http:\\<ip>\liv
<b>Selection</b>	Yes, No
<b>Factory setting</b>	Yes

---

**"Authentication" submenu**

---

<b>Navigation</b>	 Expert → Communication → Ethernet → Configuration Web server → Authentication
<b>Description</b>	Set the passwords for the various users with which the device can be accessed via Web server. Only relevant if the device is not protected by user administration.

	Operator	Admin	Service
Measured value display	Yes	Yes	Yes
Display instrument health status	Yes	Yes	Yes
Configuration	No	Yes	Yes
Configuration incl. service parameter	No	No	Yes
Update firmware	No	Yes	Yes
WebDAV	Yes	Yes	Yes

 Note: The following passwords should be changed during commissioning.

---

**Operator**

---

---

**ID**

---

<b>Navigation</b>	 Expert → Communication → Ethernet → Configuration Web server → Authentication → ID Direct access code: 470104-000
<b>Description</b>	ID required in order to access the device. Pay attention to case-sensitivity. Cannot be edited.
<b>Factory setting</b>	operator

---

**Password**

---

<b>Navigation</b>	 Expert → Communication → Ethernet → Configuration Web server → Authentication → Password Direct access code: 470105-000
<b>Description</b>	Enter a password for this user account. Pay attention to case-sensitivity.
<b>User entry</b>	Text (max. 12 characters)
<b>Factory setting</b>	operator

---

**Administrator**

---

---

**ID**

---

<b>Navigation</b>	 Expert → Communication → Ethernet → Configuration Web server → Authentication → ID Direct access code: 470101-000
<b>Description</b>	ID required in order to access the device. Pay attention to case-sensitivity. Cannot be edited.
<b>Factory setting</b>	admin

---

**Password**

---

<b>Navigation</b>	 Expert → Communication → Ethernet → Configuration Web server → Authentication → Password Direct access code: 470102-000
<b>Description</b>	Enter a password for this user account. Pay attention to case-sensitivity.
<b>User entry</b>	Text (max. 12 characters)
<b>Factory setting</b>	admin

---

**Service**



---



---

**ID**



---

<b>Navigation</b>	 Expert → Communication → Ethernet → Configuration Web server → Authentication → ID Direct access code: 470107-000
<b>Description</b>	ID required in order to access the device. Pay attention to case-sensitivity. Cannot be edited.
<b>Factory setting</b>	service

---

**Password**

---

<b>Navigation</b>	 Expert → Communication → Ethernet → Configuration Web server → Authentication → Password Direct access code: 470108-000
<b>Description</b>	Enter a password for this user account. Pay attention to case-sensitivity.
<b>User entry</b>	Text (max. 12 characters)
<b>Factory setting</b>	service

---

**"Timeouts" submenu**

---

<b>Navigation</b>	 Expert → Communication → Ethernet → Configuration Web server → Timeouts
-------------------	---

**Description** Timeouts for the Web server. Settings should only be modified if slow network connections are causing transmission problems.



The settings are only adopted if the browser has been restarted or a new tab opened. Caution: Settings should only be changed by experts.

---

### Connection quality

---

**Navigation**  Expert → Communication → Ethernet → Configuration Web server → Timeouts → Connection quality  
Direct access code: 470200-000

**Description** Configuration of typical timeout values for the Web server connection.



The default values can be changed if necessary.

**Selection** Please select, Local network (LAN/WLAN), Wireless/mobile (fast connect.), Wireless/mobile (slow connect)

**Factory setting** Please select

---

### Get timeout

---

**Navigation**  Expert → Communication → Ethernet → Configuration Web server → Timeouts → Get timeout  
Direct access code: 470201-000

**Description** Maximum time to load a new page before the browser ends the connection.

**User entry** 5 to 999 s

**Factory setting** 25

---

### Set timeout

---

**Navigation**  Expert → Communication → Ethernet → Configuration Web server → Timeouts → Set timeout  
Direct access code: 470202-000

**Description** Maximum time to write a value or execute an action before the browser ends the connection.

**User entry** 5 to 999 s

**Factory setting** 5

---

**Put timeout**



---

<b>Navigation</b>	 Expert → Communication → Ethernet → Configuration Web server → Timeouts → Put timeout Direct access code: 470203-000
<b>Description</b>	Maximum time to transmit files to or from the device before the browser ends the connection.
<b>User entry</b>	5 to 9999 s
<b>Factory setting</b>	240

---

**Ping interval**



---

<b>Navigation</b>	 Expert → Communication → Ethernet → Configuration Web server → Timeouts → Ping interval Direct access code: 470204-000
<b>Description</b>	Interval in which the browser checks device reachability.  The check is switched off if 0s is set. This is for diagnostic purposes only and should not be set!
<b>User entry</b>	0 to 999 s
<b>Factory setting</b>	10

---

**Ping timeout**

---

<b>Navigation</b>	 Expert → Communication → Ethernet → Configuration Web server → Timeouts → Ping timeout Direct access code: 470205-000
<b>Description</b>	Time in which the device must respond before the browser ends the connection.
<b>User entry</b>	5 to 999 s
<b>Factory setting</b>	15

---

**Ping retry**

---



---

<b>Navigation</b>	 Expert → Communication → Ethernet → Configuration Web server → Timeouts → Ping retry Direct access code: 470206-000
<b>Description</b>	Number of retries if the device does not respond.
<b>User entry</b>	0 to 5
<b>Factory setting</b>	0

---

### Poll timeout

---

<b>Navigation</b>	 Expert → Communication → Ethernet → Configuration Web server → Timeouts → Poll timeout Direct access code: 470207-000
<b>Description</b>	Maximum permitted time to refresh the website.
<b>User entry</b>	5 to 999 s
<b>Factory setting</b>	5

---

### "HART" submenu

---

<b>Navigation</b>	 Expert → Communication → HART
<b>Description</b>	Specify the values that should be read out via HART.

---

### Master type

---

<b>Navigation</b>	 Expert → Communication → HART → Master type Direct access code: 550010-000
<b>Description</b>	Select the HART master type – usually "Primary". Select "Secondary" if another device (e.g. a PLC) is already operating as the primary master.
<b>Selection</b>	Primary, Secondary
<b>Factory setting</b>	Primary

---

### Attempts on error

---



<b>Navigation</b>	 Expert → Communication → HART → Attempts on error Direct access code: 550011-000
-------------------	---

<b>Description</b>	Number of attempts to establish HART communication before a communication error is issued.
<b>User entry</b>	0 to 99
<b>Factory setting</b>	3

---

### Fault mode

---

<b>Navigation</b>	 Expert → Communication → HART → Fault mode Direct access code: 550013-000
<b>Description</b>	If HART communication is disrupted, the primary process variable (PV) can be calculated if a valid current is present.  This function is not possible in Multidrop mode. Start/end of measuring range must be correctly configured.
<b>Selection</b>	PV rendered invalid, Calculate PV based on current
<b>Factory setting</b>	PV rendered invalid

---

### Add value

---

<b>Navigation</b>	 Expert → Communication → HART → Add value Direct access code: 550300-000
<b>Description</b>	A value read from a connected HART device is added.
<b>Selection</b>	No, Yes
<b>Factory setting</b>	No

---

### Delete value

---

<b>Navigation</b>	 Expert → Communication → HART → Delete value Direct access code: 550301-000
<b>Description</b>	Deletes a process value from the list.
<b>Selection</b>	No, Value x
<b>Factory setting</b>	No

---

**"Value x" submenu**

---

<b>Navigation</b>	 Expert → Communication → HART → Value x
<b>Description</b>	Specify the value that should be read out via HART. Note: This value must then be assigned to a channel for universal inputs.

---

**Connection**



---

<b>Navigation</b>	 Expert → Communication → HART → Value x → Connection Direct access code: 550000-0xx
<b>Description</b>	Select the physical channel to which the HART device is connected and from which you wish to query the value.
<b>Selection</b>	Switched off, Channel x
<b>Factory setting</b>	Switched off

---

**Device address**

---

<b>Navigation</b>	 Expert → Communication → HART → Value x → Device address Direct access code: 550001-0xx
<b>Description</b>	Enter the device address of the HART device.  Note: The entered device address must match the address set in the HART device (polling address; HART address).
<b>User entry</b>	0 to 62
<b>Factory setting</b>	0

---

**Process variable**

---

<b>Navigation</b>	 Expert → Communication → HART → Value x → Process variable Direct access code: 550002-0xx
<b>Description</b>	Select the process variable that should be requested.
<b>Selection</b>	Primary process variable (PV), Secondary process variable (SV), Third process variable (TV), Fourth process variable (QV)
<b>Factory setting</b>	Primary process variable (PV)

---

**Channel ident**



---

<b>Navigation</b>	 Expert → Communication → HART → Value x → Channel ident. Direct access code: 550003-0xx
<b>Description</b>	Designation of the measuring point connected to this input.
<b>User entry</b>	Text (max. 16 characters)
<b>Factory setting</b>	Value x

---

**"Serial interface" submenu**



---

<b>Navigation</b>	 Expert → Communication → Serial interface
<b>Description</b>	Contains the set-up required if you are using the RS232 or RS485 unit interface.

---

**Type**



---

<b>Navigation</b>	 Expert → Communication → Serial interface → Type Direct access code: 150100-000
<b>Description</b>	Configure how the serial interface is used. Pay attention to the connections.
<b>Selection</b>	RS232, RS485, Debug (only for service purposes)
<b>Factory setting</b>	RS232

---

**Protocol**

---

<b>Navigation</b>	 Expert → Communication → Serial interface → Protocol Direct access code: 150105-000
<b>Description</b>	Define the serial interface protocol. Note: The device automatically disables incompatible settings.
<b>Selection</b>	PC software, Printer, Modbus Slave (only if type = RS485), Modbus Master (only if type = RS485)
<b>Factory setting</b>	PC software

---

**Baud rate**

---

---

<b>Navigation</b>	 Expert → Communication → Serial interface → Baud rate Direct access code: 150101-000
<b>Description</b>	Transmission speed ("Baud rate") - must be the same as the settings for the PC software.
<b>Selection</b>	9600, 19200, 38400, 57600, 115200
<b>Factory setting</b>	19200

---

### Parity

---

<b>Navigation</b>	 Expert → Communication → Serial interface → Parity Direct access code: 150103-000
<b>Description</b>	Parity Only visible if protocol ≠ PC software
<b>Selection</b>	None, Even, Odd
<b>Factory setting</b>	None

---

### Stop bits

---

<b>Navigation</b>	 Expert → Communication → Serial interface → Stop bits Direct access code: 150104-000
<b>Description</b>	Stop bits Only visible if protocol ≠ PC software
<b>Selection</b>	1, 2
<b>Factory setting</b>	1

---

### Device address



---

<b>Navigation</b>	 Expert → Communication → Serial interface → Device address Direct access code: 150102-000
<b>Description</b>	Every device operating using RS232 / RS485 must have an individual address (00-30). Only visible if type = RS485
<b>User entry</b>	0 to 30
<b>Factory setting</b>	0

---

**"Modbus Slave" submenu (option)**



---

<b>Navigation</b>	 Expert → Communication → Modbus Slave
<b>Description</b>	Configure the Modbus settings for the device.  Detailed descriptions of this device option can be found in the associated documentation.

---

**Modbus**



---

<b>Navigation</b>	 Expert → Communication → Modbus Slave → Modbus Direct access code: 480000-000
<b>Description</b>	Specify the physical interface you wish to use.
<b>Selection</b>	Not used, RS485, Ethernet
<b>Factory setting</b>	Not used

---

**Device address**



---

<b>Navigation</b>	 Expert → Communication → Modbus Slave → Device address Direct access code: 480001-000
<b>Description</b>	Enter the device address where it should be possible to reach this device in the bus. Only visible if Modbus = RS485
<b>User entry</b>	1 to 247
<b>Factory setting</b>	1

---

**Port**

---

<b>Navigation</b>	 Expert → Communication → Modbus Slave → Port Direct access code: 480004-000
<b>Description</b>	Port via which the Modbus protocol can be activated. Only visible if Modbus = Ethernet
<b>User entry</b>	Number (max. 5 digits)
<b>Factory setting</b>	502

---

**"Serial interface" submenu**

---

**Navigation**  Expert → Communication → Modbus Slave → Serial interface

**Description** Contains settings for the serial interface.  
Only visible if Modbus = RS485

---

**Baud rate**

---

**Navigation**  Expert → Communication → Modbus Slave → Serial interface → Baud rate  
Direct access code: 150101-000

**Description** Transmission speed ("Baud rate") - must be the same as the settings for the PC software.  
Only visible if Modbus = RS485

**Selection** 9600, 19200, 38400, 57600, 115200

**Factory setting** 19200

---

**Parity**

---

**Navigation**  Expert → Communication → Modbus Slave → Serial interface → Parity  
Direct access code: 150103-000

**Description** Parity  
Only visible if Modbus = RS485

**Selection** None, Even, Odd

**Factory setting** None

---

**Stop bits**

---

**Navigation**  Expert → Communication → Modbus Slave → Serial interface → Stop bits  
Direct access code: 150104-000

**Description** Parity  
Only visible if Modbus = RS485 and parity = None



**Selection** 1, 2

**Factory setting** 1

---

**"Modbus Master" submenu**



---

<b>Navigation</b>	 Expert → Communication → Modbus Master
<b>Description</b>	Configure the Modbus settings for the device.  Detailed descriptions of this device option can be found in the associated documentation.

---

**Modbus**



---

<b>Navigation</b>	 Expert → Communication → Modbus Master → Modbus Direct access code: 480050-000
<b>Description</b>	Specify the physical interface you wish to use.
<b>Selection</b>	Not used, RS485, Ethernet
<b>Factory setting</b>	Not used

---

**Scan cycle**



---

<b>Navigation</b>	 Expert → Communication → Modbus Master → Scan cycle Direct access code: 480053-000
<b>Description</b>	Cycle time for scanning the end devices. Only visible if Modbus = RS485
<b>Selection</b>	Off, 1 s, 2 s, 5 s, 10 s, 30 s, 1 min, 2 min, 5 min, 10 min
<b>Factory setting</b>	1 s

---

**Response timeout**

---

<b>Navigation</b>	 Expert → Communication → Modbus Master → Response timeout Direct access code: 480054-000
<b>Description</b>	Time within which the system must receive a response from the end device. Only visible if Modbus = RS485
<b>Selection</b>	Off, 1 s, 2 s, 5 s, 10 s, 30 s, 1 min, 2 min, 5 min, 10 min
<b>Factory setting</b>	1 s



---

**Register per command**



---

<b>Navigation</b>	 Expert → Communication → Modbus Master → Register per command Direct access code: 480055-000
<b>Description</b>	Maximum number of registers that can be read out per command.
<b>User entry</b>	3 to 125
<b>Factory setting</b>	20

---

**Connection attempts**



---

<b>Navigation</b>	 Expert → Communication → Modbus Master → Connection attempts Direct access code: 480056-000
<b>Description</b>	Number of repeated connection attempts until a slave signals a timeout. Only visible if Modbus = RS485
<b>User entry</b>	1 to 10
<b>Factory setting</b>	1

---

**Command distribution**



---

<b>Navigation</b>	 Expert → Communication → Modbus Master → Command distribution Direct access code: 480057-000
<b>Description</b>	Distributed over the scan cycle: The commands are uniformly distributed over the scan cycle. At the start of the scan cycle: The commands are sent at the start of the scan cycle with a pause between commands. A new scan commences when the scan cycle ends. Continuously: The commands are sent continuously with only a pause between commands. The scan cycle is not taken into account. Only visible if Modbus = RS485
<b>Selection</b>	Distributed over the scan cycle, At the start of the scan cycle, Continuously
<b>Factory setting</b>	Distributed over the scan cycle

---

**Pause between commands**

---

<b>Navigation</b>	 Expert → Communication → Modbus Master → Pause between commands Direct access code: 480058-000
-------------------	---

<b>Description</b>	Time system waits between a response and a new command to be sent. Only visible if Modbus = RS485
<b>User entry</b>	5 to 600000 ms
<b>Factory setting</b>	10 ms

---

### "Serial interface" submenu

---

<b>Navigation</b>	 Expert → Communication → Modbus Master → Serial interface
<b>Description</b>	Contains the settings required if you are using the RS485 interface of the device.

---

### Baud rate

---

<b>Navigation</b>	 Expert → Communication → Modbus Master → Serial interface → Baud rate Direct access code: 150101-000
<b>Description</b>	Transmission speed ("Baud rate") - must be the same as the settings for the PC software. Only visible if Modbus = RS485
<b>Selection</b>	9600, 19200, 38400, 57600, 115200
<b>Factory setting</b>	19200

---

### Parity

---

<b>Navigation</b>	 Expert → Communication → Modbus Master → Serial interface → Parity Direct access code: 150103-000
<b>Description</b>	Parity Only visible if Modbus = RS485
<b>Selection</b>	None, Even, Odd
<b>Factory setting</b>	None

---

### Stop bits

---



<b>Navigation</b>	 Expert → Communication → Modbus Master → Serial interface → Stop bits Direct access code: 150104-000
<b>Description</b>	Parity Only visible if Modbus = RS485 and parity = None

<b>Selection</b>	1, 2
<b>Factory setting</b>	1

---

### "Profibus DP" submenu (option)

---

<b>Navigation</b>	 Expert → Communication → Profibus DP
<b>Description</b>	Configure the Profibus DP settings for the device.  Detailed descriptions of this device option can be found in the associated documentation.

---

### Slave address

---

<b>Navigation</b>	 Expert → Communication → Profibus DP → Slave address Direct access code: 480100-000
<b>Description</b>	Enter the device address where it should be possible to reach this device in the bus.
<b>User entry</b>	1 to 125
<b>Factory setting</b>	1

---

### Show status

---

<b>Navigation</b>	 Expert → Communication → Profibus DP → Show status Direct access code: 480101-000
<b>Description</b>	The status is shown on the display in addition to the measured value. Status changes are saved in the event log.
<b>Selection</b>	No, Yes
<b>Factory setting</b>	No

---

### "Slot x" submenu

---

<b>Navigation</b>	 Expert → Communication → Profibus DP → Slot x
<b>Description</b>	Slot assignment of the channels. Settings only required if you wish to connect the device to a PLC via Profibus DP.

---

### Master In/Out

---

<b>Navigation</b>	 Expert → Communication → Profibus DP → Slot x → Master In/Out Direct access code: 480110-0xx Examples: Slot 1: 480110-000; Slot 16: 480110-015
<b>Description</b>	Selection of the modules that can be selected in the PLC. AI/AO: Transmission of a floating point number + status. DI/DO: Transmission of digital statuses. AI/DI: To the PLC. AO/DO: From the PLC.
<b>Selection</b>	Not used, 1 AI-PA: 5 Byte, 2 AI-PA: 10 Byte, 3 AI-PA: 15 Byte, 4 AI-PA: 10 Word, 8 DI: 2 Byte, 1 AO-PA: 5 Byte, 2 AO-PA: 10 Byte, 3 AO-PA: 15 Byte, 4 AO-PA: 10 Word, 8 DO: 2 Byte
<b>Factory setting</b>	Not used

---

### Byte x...y

---

<b>Navigation</b>	 Expert → Communication → Profibus DP → Slot x → Byte x...y Direct access code, byte 0..4: 480111-0xx Direct access code, byte 5..9: 480113-0xx Direct access code, byte 10..14: 480115-0xx Direct access code, byte 15..19: 480117-0xx Examples: Slot 1, byte 0..4: 480111-000; Slot 16: 480111-015
<b>Description</b>	Please select the value that should be used within the module from this address offset.
<b>Selection</b>	Switched off, Universal input x, Digital input x, Maths x, Limit x, Relay x Note: All active inputs are available for selection.
<b>Factory setting</b>	Switched off

---

-->

---

<b>Navigation</b>	 Expert → Communication → Profibus DP → Slot x → --> Direct access code, byte 0..4 -->: 480112-0xx Direct access code, byte 5..9 -->: 480114-0xx Direct access code, byte 10..14 -->: 480116-0xx Direct access code, byte 15..19 -->: 480118-0xx Examples: Slot 1, byte 0..4 -->: 480112-000; Slot 16 -->: 480112-015
<b>Description</b>	Data type of the value to be transmitted. Note: Item only visible if a digital input with the function Operational time, Event +operation time or Quantity from time has been selected under "Byte x..y".
<b>Selection</b>	Not used, Instantaneous value, State, Totalizer, Total operational time
<b>Factory setting</b>	Not used

---

**Bit 0.0 to 0.7**

---

<b>Navigation</b>	 Expert → Communication → Profibus DP → Slot x → Bit 0.0 ... 0.7 Direct access code, bit 0.0: 480111-0xx Direct access code, bit 0.1: 480113-0xx Direct access code, bit 0.2: 480115-0xx Direct access code, bit 0.3: 480117-0xx Direct access code, bit 0.4: 480119-0xx Direct access code, bit 0.5: 480120-0xx Direct access code, bit 0.6: 480121-0xx Direct access code, bit 0.7: 480122-0xx Examples: Slot 1, bit 0.0: 480111-000; Slot 16: 480111-015
<b>Description</b>	Please select the value that should be used within the module from this address offset.
<b>Selection</b>	Switched off, Universal input x, Digital input x, Maths x, Limit x, Relay x All active inputs are available for selection.
<b>Factory setting</b>	Switched off



### 17.1.5 "Application" submenu

Configure various application-specific settings (e.g. group settings, limit values, etc.).

---

**"Maths - Maths x" submenu**  
 (Online configuration)
 

---

<b>Navigation</b>	 Expert → Application → Maths → Maths x
<b>Description</b>	Configuration of the mathematics channels.  x = place holder for selected mathematics channel

---

**Function**



---

<b>Navigation</b>	 Expert → Application → Maths → Maths x → Function Direct access code: 400000-000 Examples: Maths 1: 400000-000; Maths 4: 400000-003
<b>Description</b>	Switch the mathematics channel on or off.
<b>Selection</b>	Switched off, Formula editor Included with energy package (option): Energy calculation, mass calculation, density calculation, calculation of enthalpy, mass calculation DP-Flow
<b>Factory setting</b>	Switched off

---

<b>Channel ident.</b>	
-----------------------	--



---

<b>Navigation</b>	 Expert → Application → Maths → Maths x → Channel ident. Direct access code: 400001-000 Examples: Maths 1: 400001-000; Maths 4: 400001-003
<b>Description</b>	Measurement point name (e.g. "Pump") or description of the function of this input (e.g. "Fault message").
<b>User entry</b>	Text (max. 16 characters)
<b>Factory setting</b>	Maths x

---

<b>Formula</b>	
----------------	--

---

<b>Navigation</b>	 Expert → Application → Maths → Maths x → Formula Direct access code: 400002-000 Examples: Maths 1: 400002-000; Maths 4: 400002-003
<b>Description</b>	Enter the desired calculation formula. The formula can be any combination of arithmetic calculations and logical operations. Analog, digital or already active mathematics channels can be used. Description of formula editor →  224 Only visible if function = Formula editor
<b>User entry</b>	Formula

---

<b>Application</b>	
--------------------	--

---

<b>Navigation</b>	 Expert → Application → Maths → Maths x → Application Direct access code: 400100-0xx Examples: Maths 1: 400100-000; Maths 4: 400100-003
<b>Description</b>	Please select application. Only visible with energy package (option) and selected energy function.
<b>Selection</b>	Water heat quantity, Water heat difference, Steam heat quantity, Steam heat difference, Water/glycol heat difference, Water DP flow, Steam DP flow, Liquids DP flow, Gas DP flow
<b>Factory setting</b>	Water heat quantity or Water DP flow (depends on selected function)

---

<b>Device type</b>	
--------------------	--

---

<b>Navigation</b>	 Expert → Application → Maths → Maths x → Device type Direct access code: 400122-0xx Examples: Maths 1: 400122-000; Maths 4: 400122-003
<b>Description</b>	Configure the transmitter type used. Only visible with energy package (option) and function = Mass calculation DP-Flow.
<b>Selection</b>	Orifice (corner), Orifice (D/D2), Orifice (flange), Nozzle (ISA1932), Nozzle (l.radius), Venturi nozzle, Venturi tbe, cast, Venturi tbe, bear., Venturi tbe, steel, V-cone, Pitot tube, Gilflo
<b>Factory setting</b>	Orifice (corner)

---

### Flow

---

<b>Navigation</b>	 Expert → Application → Maths → Maths x → Flow Direct access code: 400101-0xx Examples: Maths 1: 400101-000; Maths 4: 400101-003
<b>Description</b>	Please select a flow input. Only visible with energy package (option) and function = Energy or Mass calculation.
<b>Selection</b>	Switched off, Universal input x, Maths x All active inputs are available for selection.
<b>Factory setting</b>	Switched off

---

### Engineering unit

---

<b>Navigation</b>	 Expert → Application → Maths → Maths x → Engineering unit Direct access code: 400102-0xx Examples: Maths 1: 400102-000; Maths 4: 400102-003
<b>Description</b>	Please select the unit you would like to use for scaling the selected flow input. Only visible with energy package (option) and selected flow input.
<b>Selection</b>	m <sup>3</sup> /h, l/h, ft <sup>3</sup> /m, ft <sup>3</sup> /h, gpm, gal/h, kg/h, t/h, ton/h, lb/h
<b>Factory setting</b>	m <sup>3</sup> /h

---

### Flow installation point

---

<b>Navigation</b>	 Expert → Application → Maths → Maths x → Flow installation point Direct access code: 400103-0xx Examples: Maths 1: 400103-000; Maths 4: 400103-003
-------------------	--

<b>Description</b>	Please specify where the flow sensor is installed. This is important so that the correct temperature is used for density calculation. Only visible with energy package (option) and active flow input.
<b>Selection</b>	Steam, Water, Warm, Cold (depending on the selected application)
<b>Factory setting</b>	Steam or warm (depending on the selected application)

---

## Pressure

---

<b>Navigation</b>	 Expert → Application → Maths → Maths x → Pressure Direct access code: 400104-0xx Examples: Maths 1: 400104-000; Maths 4: 400104-003
<b>Description</b>	Please select a pressure input. If you select "deactivated" the temperature input is used to calculate the saturated steam conditions. Only visible with energy package (option) and selected steam application.
<b>Selection</b>	Switched off, Universal input x, Maths x All active inputs are available for selection.
<b>Factory setting</b>	Switched off

---

## Engineering unit

---

<b>Navigation</b>	 Expert → Application → Maths → Maths x → Engineering unit Direct access code: 400105-0xx Examples: Maths 1: 400105-000; Maths 4: 400105-003
<b>Description</b>	Please select the unit used for scaling the selected pressure input. Only visible with energy package (option) and selected steam application. Only visible with energy packet (option) and active pressure input.
<b>Selection</b>	bar (a), psi (a), MPa (a), inH2O (a), bar (g), psi (g), MPa (g), inH2O (g)
<b>Factory setting</b>	bar (a)

---

## Temperature (water/steam/warm)

---

<b>Navigation</b>	 Expert → Application → Maths → Maths x → Temperature (water/steam/warm) Direct access code: 400106-0xx Examples: Maths 1: 400106-000; Maths 4: 400106-003
-------------------	---



<b>Description</b>	Please select the temperature input used to measure the warm side (or steam line). If "Switched off" is selected the pressure input is used to calculate the saturated steam conditions (only for steam applications). Only visible with energy package (option) and selected energy function.
<b>Selection</b>	Switched off, Universal input x, Maths x All active inputs are available for selection.
<b>Factory setting</b>	Switched off

---

### Temperature (steam/cold)

---

<b>Navigation</b>	 Expert → Application → Maths → Maths x → Temperature (steam/cold) Direct access code: 400107-0xx Examples: Maths 1: 400107-000; Maths 4: 400107-003
<b>Description</b>	Please select the temperature input used to measure the cold side (or condensate line). Only visible with energy package (option) and selected heat difference measurement.
<b>Selection</b>	Switched off, Universal input x, Maths x All active inputs are available for selection.
<b>Factory setting</b>	Switched off

---

### Engineering unit

---

<b>Navigation</b>	 Expert → Application → Maths → Maths x → Engineering unit Direct access code: 400108-0xx Examples: Maths 1: 400108-000; Maths 4: 400108-003
<b>Description</b>	Please select the unit used for scaling the selected temperature sensors. Only visible with energy package (option) and selected energy function.
<b>Selection</b>	°C, °F, K
<b>Factory setting</b>	°C

---

### Medium

---

<b>Navigation</b>	 Expert → Application → Maths → Maths x → Medium Direct access code: 400110-0xx Examples: Maths 1: 400110-000; Maths 4: 400110-003
<b>Description</b>	Select a cooling medium. If the medium used is not in list, select ethylene glycol or propylene glycol. Only visible with energy package (option) and application = Water/glycol heat difference.

**Selection** Ethylene-glycol, Antifrogen N, Glykosol N, Propylene-glycol

**Factory setting** Ethylene-glycol

---

### Water/glycol concentration

---

**Navigation**  Expert → Application → Maths → Maths x → Water/glycol concentration  
Direct access code: 400109-0xx  
Examples: Maths 1: 400109-000; Maths 4: 400109-003

**Description** Concentration of the water/glycol mixture in vol % (0-60 %).  
Only visible with energy package (option) and application = Water/glycol heat difference.

**User entry** 0 to 60 %

**Factory setting** 20 %

---

### The result is

---

**Navigation**  Expert → Application → Maths → Maths x → The result is  
Direct access code: 400003-000  
Examples: Maths 1: 400003-000; Maths 4: 400003-003

**Description** Configure which data type the calculation returns. This setting affects how the channel saves and is displayed.  
If you add 2 analog channels, for example, the result is an "instantaneous value".  
If you logically link 2 channels, for example, (digital 1 AND digital 2), the result is a "state" (on/off).  
Instantaneous value: If, for example, 2 analog channels are added (AI(1;1)+AI(1;2)), the result is an instantaneous value.  
State: The state/status of an individual analog input can be output as the result. A relay can also be actuated as a result.  
Counter: If, for example, 2 counters from digital inputs are added (DI(3;1)+DI(3;5)), the result is a counter.  
Operating time from status: The status (logical "1" or "0") of one or more digital inputs that are connected by addition can be analyzed. If the result of the calculation is not equal to 0, the counter for the operating time starts. The time is increased by 0.1 s every 100 ms.  
Operating time from total: If several digital inputs that are configured as "operational time" are added together, the result is the total of all the individual operating times.  
Control input: The function corresponds to a digital input that has been configured as a control input.

**Selection** Instantaneous value, State, Counter, Operating time from status, Operating time from total, Control input, Efficiency

**Factory setting** Instantaneous value

---

**Plot type**



---

<b>Navigation</b>	 Expert → Application → Maths → Maths x → Plot type Direct access code: 400015-000 Examples: Maths 1: 400015-000; Maths 4: 400015-003
<b>Description</b>	The mathematics channels are recalculated every 100 ms. Depending on the save cycle, the selected data are determined/saved from the calculated values.
<b>Selection</b>	Instantaneous value, Average, Minimum value, Maximum value, Minimum + Maximum, Counter, Current value + Counter
<b>Factory setting</b>	Average

---

**Engineering unit**



---

<b>Navigation</b>	 Expert → Application → Maths → Maths x → Engineering unit Direct access code: 400004-000 Examples: Maths 1: 400004-000; Maths 4: 400004-003
<b>Description</b>	Unit of the calculated value. Only visible if the result is = Instantaneous value, Counter or Efficiency
<b>User entry</b>	Text (max. 6 characters)

---

**Engineering unit**

---

<b>Navigation</b>	 Expert → Application → Maths → Maths x → Engineering unit Direct access code: 400111-000 Examples: Maths 1: 400111-000; Maths 4: 400111-003
<b>Description</b>	Unit of the calculated value. Only visible with energy package (option) and selected energy function.
<b>Selection</b>	kW, MW, GJ/h, kBtu/m, kBtu/h, MBtu/h, ther/m, ther/h, ton, RT, kg/h, t/h, lbs/h, ton/h, kg/m <sup>3</sup> , lb/ft <sup>3</sup> , kJ/kg, Btu/lb
<b>Factory setting</b>	(Depends on the selected function)

---

**Decimal point**

---

**Navigation**

 Expert → Application → Maths → Maths x → Decimal point  
 Direct access code: 400005-000  
 Examples: Maths 1: 400005-000; Maths 4: 400005-003

**Description**

Number of places after decimal point for the display.  
 Only visible if function = Formula editor, Energy calculation, Mass calculation, Density calculation, Calculation of enthalpy and the result is = Instantaneous value, Counter or Efficiency.

**Selection**

None, One (X.Y), Two (X.YY), Three (X.YYY), Four (X.YYYY), Five (X.YYYYY)

**Factory setting**

One (X.Y)

**Action****Navigation**

 Expert → Application → Maths → Maths x → Action  
 Direct access code: 400006-000  
 Examples: Maths 1: 400006-000; Maths 4: 400006-003

**Description**

Set up the function of the control input.  
 Only visible if the result is = Control input

Action	Description
Start/stop recording	The device only saves data as long as a high signal is present
Screensaver on	Switches backlighting/display off, low = off, high = on
Lock setup	The user can only change the setup if a low signal is present
Time synchronization	If a high signal is applied, the device rounds the system time up or down (only for Low→High change): 0 to 29 → round down; 30 to 59 → round up
Change the group	The display switches to the next active group in the event of a Low→High change.
Set point monitoring on/off	The entire set point monitoring function of the device can be switched on (for "High") or switched off (for "Low").
Individual LV on/off	Monitoring for a selected limit value can be switched on (for "High") or switched off (for "Low").
Block keyboard/navigator	The device can only be operated if a low signal is present. Otherwise all key activation and navigator actions are discarded.
Start/stop analysis 1-4	Starts/ends one of the max. 4 external analyses (the analysis runs only as long as the signal is high). Measured value acquisition for the graphic display continues. Batches are also started/ended with this function. Note: This function is not available in the case of batch and control input via a maths channel.
Reset batch number x (option)	Resets the automatically generated batch number (1..x) to 0 (in the event of a LowHigh change).
Batch x limit values on/off (option)	Switches the limits of batch x on/off. The limits relating to the batch are determined based on the group settings (via the channels assigned to the batch). If a channel is assigned to several batches, the limits for this channel are not disabled.

**Selection**

Switched off, Start/stop recording, Screensaver on, Lock setup, Time synchronization, Change group, Set point monitoring on/off, Individual LV on/off, Block keyboard/navigator, Start/stop analysis x, Reset batch no. x, Batch x limits on/off

**Factory setting** Switched off

---

### Set point

---

**Navigation**  Expert → Application → Maths → Maths x → Set point  
 Direct access code: 400019-000  
 Examples: Maths 1: 400019-000; Maths 4: 400019-003

**Description** Select the set point which should be switched on or off by means of this control input.  
 Only visible if action = Individual LV on/off

**Selection** Switched off, Limit x

**Factory setting** Switched off

---

### Switches relay

---

**Navigation**  Expert → Application → Maths → Maths x → Switches relay  
 Direct access code: 400007-000  
 Examples: Maths 1: 400007-000; Maths 4: 400007-003

**Description** Switches the respective relay when the digital input is low or high.  
 Only visible if the result is = Control input or State

**Selection** Not used, Relay x  
 All the available relays are displayed.

**Factory setting** Not used

---

### Description 'H'

---

**Navigation**  Expert → Application → Maths → Maths x → Description 'H'  
 Direct access code: 400008-00x  
 Examples: Maths 1: 400008-000; Maths 4: 400008-003

**Description** Condition description when the digital input is active. This text is both shown on the display and saved to memory.  
 Only visible if the result is = Control input or State

**User entry** Text (max. 6 characters)

**Factory setting** On

---

<b>Description 'L'</b>	
------------------------	--



---

<b>Navigation</b>	 Expert → Application → Maths → Maths x → Description 'L' Direct access code: 400009-00x Examples: Maths 1: 400009-000; Maths 4: 400009-003
<b>Description</b>	Condition description when the digital input is not active. This text is both shown on the display and saved to memory. Only visible if the result is = Control input or State
<b>User entry</b>	Text (max. 6 characters)
<b>Factory setting</b>	Off

---

<b>Save event</b>	
-------------------	--



---

<b>Navigation</b>	 Expert → Application → Maths → Maths x → Save event Direct access code: 400010-00x Examples: Maths 1: 400010-000; Maths 4: 400010-003
<b>Description</b>	Determines whether the condition change from low to high or high to low is stored in the event log.  Requires higher memory capacity. Only visible if the result is = Control input or State
<b>Selection</b>	No, Yes, only "On" message
<b>Factory setting</b>	Yes

---

<b>Event message</b>	
----------------------	--

---

<b>Navigation</b>	 Expert → Application → Maths → Maths x → Event message Direct access code: 400018-00x Examples: Maths 1: 400018-000; Maths 4: 400018-003
<b>Description</b>	"Do not acknowledge": No message is shown if the state of the mathematics channel changes. "Acknowledge": A message window is shown on the screen which has to be acknowledged by operating a push button. Only visible if the result is = Control input or State  Note: In the case of the DIN rail version, the message can only be acknowledged via the Web server!
<b>Selection</b>	Do not acknowledge, Acknowledge

**Factory setting** Do not acknowledge

---

### Event text L->H

---

**Navigation**  Expert → Application → Maths → Maths x → Event text L->H  
Direct access code: 400011-00x  
Examples: Maths 1: 400011-000; Maths 4: 400011-003

**Description** Description of condition change from low to high. Event text is stored (e.g. Start filling).  
Only visible if the result is = Control input or State

**User entry** Text (max. 22 characters)

---

### Event text H->L

---

**Navigation**  Expert → Application → Maths → Maths x → Event text H->L  
Direct access code: 400012-00x  
Examples: Maths 1: 400012-000; Maths 4: 400012-003

**Description** Description of condition change from high to low. Event text is stored (e.g. Stop filling).  
Only visible if the result is = Control input or State

**User entry** Text (max. 22 characters)

---

### Record duration

---

**Navigation**  Expert → Application → Maths → Maths x → Record duration  
Direct access code: 400013-00x  
Examples: Maths 1: 400013-000; Maths 4: 400013-003

**Description** The duration between "On" and "Off" can be recorded. The duration is appended to the "Off" event text (<hhhh>h<mm>:<ss>).  
Power failure times do not affect the duration. If the digital channel was "on" before the power failure and is still "on" after the power failure, the duration continues.  
Only visible if the result is = Control input or State

**Selection** No, Yes

**Factory setting** No

---

### Zoom start

---

---

<b>Navigation</b>	 Expert → Application → Maths → Maths x → Zoom start Direct access code: 400016-00x Examples: Maths 1: 400016-000; Maths 4: 400016-003
<b>Description</b>	If the whole value range is not used, you can configure the lower value of the required section here. The zoom has no influence on the storage. Only visible if the result is = Instantaneous value
<b>User entry</b>	Number (max. 8 digits)
<b>Factory setting</b>	0

---

### Zoom end

---

<b>Navigation</b>	 Expert → Application → Maths → Maths x → Zoom end Direct access code: 400017-00x Examples: Maths 1: 400017-000; Maths 4: 400017-003
<b>Description</b>	Like "Zoom start". Enter the upper value of the required range here. Only visible if the result is = Instantaneous value
<b>User entry</b>	Number (max. 8 digits)
<b>Factory setting</b>	100

---

### Totalizer (Online configuration)

---

<b>Navigation</b>	 Expert → Application → Maths → Maths x → Totalizer Direct access code: 400014-00x Examples: Maths 1: 400014-000; Maths 4: 400014-003
<b>Description</b>	Initial setting for the totalizer. Useful when continuing measurements recorded to date with an (electro)-mechanical counter. Only visible if the result is = Counter, Operating time from status or Operating time from total
<b>User entry</b>	Number (max. 15 digits)
<b>Factory setting</b>	0

### Formula editor

Enter the desired calculation formula.

The formula can be any combination of arithmetic calculations and logical operations.





Analog, digital or already active mathematics channels can be used.

**Formula editor**

**Navigation**

 Expert → Application → Maths → Maths x → Formula  
Direct access code: 400002-000

 x = place holder for selected mathematics channel

 A text field with the formula currently used appears. If the field is empty a formula has not yet been defined for the mathematics channel.

**Description**

Individual channels can be mathematically linked and calculated with functions. The mathematics channels calculated in this way are treated as "real" channels, regardless of whether they are connected conventionally or via fieldbus. Enter the desired calculation formula.

The formula can be any combination of arithmetic calculations and logical operations. Analog and digital channels can be used, as can mathematics channels that are already active.

A formula with up to 200 characters can be created using this editor. If the formula is finished, click OK to close the editor and accept the formula entered. The common entry and arithmetic operators and inputs are described in detail in the following sections.

*Inputs*

Inputs are described in the formula using the following syntax:

**Input type (signal type;channel number)**

Type of input	Description
AI	Analog inputs
DI	Digital inputs
MI	Mathematics inputs

Signal type	Description
1	Instantaneous value (measured value)
2	State
3	Counter/operational time
5	Validity: The validity of an analog channel or a mathematics channel is relayed. The relayed value of the function is 0 in the event of: <ul style="list-style-type: none"> <li>▪ Open circuit</li> <li>▪ Invalid measured value</li> <li>▪ Sensor error</li> <li>▪ Input signal too high/low</li> <li>▪ Error value</li> </ul> The relayed value of the function is 1 in the event of: Measured value OK, even if the limit value is breached
6	Delta count
7 to 10	Analysis 1 to 4

Signal type	Description
11	Totalizer
12	Duration

 Not all signal types are available for each input type. These depend on the respective device options.

**Channel number:**

Analog channel 1 = 1, analog channel 2 = 2, digital channel 1 = 1, ...

*Examples:*

DI(2;4)	State of digital channel 4
AI(1;1)	Instantaneous value of analog channel 1

**Status of a limit value:**

LMT (type, limit number)

Type	Description
1	"Instantaneous value": Currently set limit value
2	"State": The function returns the status of a limit value The result is 1 if the limit value is violated.  The result is 0 if <ul style="list-style-type: none"> <li>▪ The limit value is not violated</li> <li>▪ The limit value is not switched on</li> <li>▪ Limits monitoring is switched off (e.g. per control input)</li> </ul>

*Examples:*

LMT (1;1)	Instantaneous value of limit value 1
LMT (2;3)	State of limit value 3

*Priority of operators / functions*

The formula is processed based on universally applicable mathematics rules:

- Parentheses first
- Exponents before multiplication or division
- Multiplication or division before addition or subtraction
- Calculate from left to right

*Operators*

*Arithmetic operators:*

Operator	Function
+	Addition
-	Subtraction / negative sign
*	Multiplication
/	Division
%	Modulo (remainder of division x/y), see function "mod"
^	x to the power of y

*Relational operators:*

Operator	Function
>	Greater than
>=	Greater than or equal to
<	Less than
<=	Less than or equal to
=	Equals
<>	Not equal to

*Logical operators:*

Function	Syntax	Description	Example
	Value1    Value2	Logical "or" (see also function "or")	DI(2;1)    DI(2;2)
&&	Value1 && Value2	Logical "and" (see also function "and")	DI(2;1) && DI(2;2)

*Functions*

*Standard functions:*

Function	Syntax	Description	Example
ln	ln(number)	Returns the natural logarithm of a number. Natural logarithms are based on a constant e (2.71828182845904). For values $\leq 0$ the result is undefined. The device continues with 0	ln(86) = 4.454347
log	log(number)	Calculates the logarithm of the argument for base 10. For values $\leq 0$ the result is undefined. The device continues with 0.	log(10) = 1
exp	exp(number)	Exponentiates the base e with the number defined as the argument. The constant e is the basis of the natural logarithm and has the value 2.71828182845904.	exp(2.00) = 7.389056
abs	abs(number)	Returns the absolute value of a number. The absolute value of a number is the number without its algebraic sign.	abs(-1.23) = 1.23
pi	pi()	Returns the value of the number PI (3.14159265358979323846264)	
sqrt	sqrt(number)	sqrt calculates the positive square root of the argument "Number". The result is undefined for negative values. The device continues with 0.	sqrt(4) = 2

Function	Syntax	Description	Example
mod	mod(number; divisor)	Returns the remainder of a division. The result has the same algebraic sign as the divisor. If the divisor has the value 0, the result is undefined. The device continues with 0.	mod(5;2) = 1
rnd	rnd(number; number_digits)	Rounds a number to a certain number of decimal places. "Number" is the number to which you wish to round up/down. "Number_digits" indicates to how many decimal places you wish to round the number up/down. <b>Notes:</b> <ul style="list-style-type: none"> <li>▪ If "Number_digits" is greater than 0 (zero), the number is rounded to the specified number of decimal places.</li> <li>▪ If "Number_digits" is equal to 0, the number is rounded to the next whole number.</li> <li>▪ If "Number_digits" is less than 0, the part of the number to the left of the decimal separator is rounded.</li> </ul>	rnd(2.15;1) = 2.2 rnd(2.149;1) = 2.1 rnd(-1.475;2) = -1.48 rnd(-1.473;2) = -1.47 rnd(21.5;-1) = 20 rnd(5.5;-2) = 10 rnd(5.5;-3) = 0

*Trigonometric functions:*

Function	Syntax	Description	Example
rad	rad(number)	Conversion from degrees to radian	rad(270) = 4.712389
degrees	degrees(number)	Conversion from radian to degrees	grad(pi()) = 180

The following functions expect an angle in the radian as the argument. If the angle lies in the degree, it must be converted to the radian by multiplying it with  $\pi()/180$ . Alternatively the function "rad" can be used:

Function	Syntax	Description	Example
sin	sin(number)	Returns the sine of a number	sin(pi()) -> sine of pi radian sin(30*pi()/180) -> sine of 30 degrees (0.5)
cos	cos(number)	Conversion from radian to degrees	grad(pi()) = 180
tan	tan(number)	Returns the tangent of the argument	tan(0.785) = 0.99920

With the following functions the returned angle is specified in radian with a value between  $-\pi/2$  and  $+\pi/2$ . If the result is to be expressed in degrees, the respective result must be multiplied by  $180/\pi()$  or the "Degrees" function used:

Function	Syntax	Description	Example
asin	asin(number)	Returns the arc sine or inverse sine of a number (inverse function). The arc sine expects a real argument in the range from -1 to +1. In the event of values outside this range, the device continues with 0.	$\arcsin(-0.5) = -0.5236$ $\arcsin(-0.5) * 180/\pi() = -30^\circ$
acos	acos(number)	Returns the arc cosine or inverse cosine of a number (inverse function). The arc cosine expects a real argument in the range from -1 to +1. In the event of values outside this range, the device continues with 0.	$\arccos(-0.5) = 2.094395$
atan	atan(number)	Returns the arc tangent or inverse tangent of a number (inverse function).	$\text{atan}(1) = 0.785398$

*Logical functions:*

Function	Syntax	Description	Example
if	if(check; then_value; otherwise_value )	"Check" is any value or expression; the result can be TRUE or FALSE. This argument can adopt any comparison calculation operator. "Then_value" is the value returned if "Check" is TRUE. "Otherwise_value" is the value returned if "Check" is FALSE.	if(x>10;1;0) If value x is greater than 10 the function returns 1, otherwise 0
or	or(true1;true2)	Returns TRUE if an argument is TRUE. Returns FALSE if all arguments are FALSE. Note: See also operator " "  "	or(2>1;3>2) = true or(2<1;3>2) = true or(2<1;3<2) = false
and	and(true1;true2 )	Returns TRUE if both arguments are TRUE. If one of the arguments is FALSE, this function returns the value FALSE Note: See also operator "&&"	and(2>1;3>2) = true and(2<1;3<2) = false
not	not(truth value)	Inverts the value of an argument. NOT can be used to specify that a value does not match a specific value.	not(false) = true

XX in the following functions stands for one of the inputs described under → 225. Range functions can only ever be executed via one input type.

*Range functions:*

Function	Syntax	Description	Example
sumXX	sumXX(Type;From;To)	Totals the values for the specified range of input signals. "Type": Signal type (see → 225) "From": Channel number from which the values should be totaled (1 = channel 1) "To": Channel number to which the values should be totaled (1 = channel 1)	sumXX (1;2;5) = sum of all instantaneous values from channel 2 to 5
avgXX	avgXX(Type;From;To)	Calculates the average for the specified range of input signals.	avgXX(1;1;6)
minXX	minXX(Type;From;To)	Returns the minimum value for the specified range of input signals.	minXX(1;1;6)
maxXX	maxXX(Type;From;To)	Returns the maximum value for the specified range of input signals.	maxXX (1;1;6)

*Date/time functions:*

Function	Syntax	Description	Example
dow	dow()	Returns the current day of the week as a number between 1 and 7.	Sunday = 1 Monday = 2 Tuesday = 3 Wednesday = 4 Thursday = 5 Friday = 6 Saturday = 7
time	time()	Returns the current time in seconds.	00:00 = 0 s 12:00 = 43,200 s 23:59:59 = 86,399 s

*Decimal separator*

Both the decimal point and the decimal comma can be used in the formula editor. Thousand separators are not supported.

*Check whether formula is valid or malfunctions*

A formula is invalid if:

- The channels used are not switched on or are in the wrong operating mode (is not verified during formula entry as the channel could be switched on subsequently)
- It contains invalid characters/formulas/functions/operators
- Syntax errors (e.g. wrong number of parameters) occur in the formulas
- There are incorrect parentheses in the formula (number of open parentheses unequal to number of closed parentheses)
- Division is by zero
- A channel refers to itself (infinite recursion)

Invalid formulas are deactivated when the setup is accepted or the device is started.

Undetectable errors: wherever possible, errors in the formula are reported immediately during input. However, given the possible complexity of the formula entered (e.g. nested formulas) it is not possible to detect every error.

**"DP flow" submenu (option "Energy package")****Navigation**

 Expert → Application → Maths → Maths x → DP-Flow

**Description**

Configuration of a flow measurement following the differential pressure process. Only visible if function = Mass calculation DP-Flow

**Differential pressure****Navigation**

 Expert → Application → Maths → Maths x → DP-Flow → Differential pressure  
Direct access code: 400115-00x  
Examples: Maths 1: 400115-000; Maths 4: 400115-003

**Description**

Please select differential pressure input.

**Selection**

Switched off, Universal input x, Digital input x, Maths x  
All active inputs are available for selection.

**Factory setting** Switched off

---

### DP unit

---

**Navigation**  Expert → Application → Maths → Maths x → DP-Flow → DP unit  
 Direct access code: 400116-00x  
 Examples: Maths 1: 400116-000; Maths 4: 400116-003

**Description** Unit of the differential pressure.

**Selection** mbar, inH2O

**Factory setting** mbar

---

### Diameter unit

---

**Navigation**  Expert → Application → Maths → Maths x → DP-Flow → Diameter unit  
 Direct access code: 400118-00x  
 Examples: Maths 1: 400118-000; Maths 4: 400118-003

**Description** Unit of the internal diameter of the pipe.

**Selection** mm, Inch

**Factory setting** mm

---

### D at 20 °C

---

**Navigation**  Expert → Application → Maths → Maths x → DP-Flow → D at 20°C  
 Direct access code: 400119-00x  
 Examples: Maths 1: 400119-000; Maths 4: 400119-003

**Description** Internal pipe diameter (D) under design conditions at 20 °C/68 °F.

**User entry** Number (max. 8 characters)

**Factory setting** 100 (mm or inches)

---

### d at 20 °C

---

<b>Navigation</b>	 Expert → Application → Maths → Maths x → DP-Flow → d at 20°C Direct access code: 400120-00x Examples: Maths 1: 400120-000; Maths 4: 400120-003
<b>Description</b>	Internal pipe diameter of the throttle (d) under design conditions at 20 °C/68 °F.
<b>User entry</b>	Number (max. 8 characters)
<b>Factory setting</b>	70 (mm or inches)

---

### K-factor

---

<b>Navigation</b>	 Expert → Application → Maths → Maths x → DP-Flow → K-factor Direct access code: 400121-00x Examples: Maths 1: 400121-000; Maths 4: 400121-003
<b>Description</b>	Set the K-factor (blockage factor) for the pitot tube (see nameplate on the probe). Only visible if type = Pitot tube
<b>User entry</b>	Number (max. 8 characters)
<b>Factory setting</b>	0.6

---

### Pipe material

---

<b>Navigation</b>	 Expert → Application → Maths → Maths x → DP-Flow → Pipe material Direct access code: 400127-00x Examples: Maths 1: 400127-000; Maths 4: 400127-003
<b>Description</b>	Material of the pipe.
<b>Selection</b>	C-steel, stainless steel, 1.5415 / A182F1, 1.7335 / A182F12, 1.7380 / A182F22, 1.4922, 1.4401 / 316, 1.4404 / 316L, 1.4571 / 316Ti
<b>Factory setting</b>	C-steel

---

### Density

---

<b>Navigation</b>	 Expert → Application → Maths → Maths x → DP-Flow → Density Direct access code: 400123-00x Examples: Maths 1: 400123-000; Maths 4: 400123-003
<b>Description</b>	Please select density input or mathematics channel, in which the density is calculated. Only visible if application = DP-Flow liquids or DP-Flow gas



**Selection** Switched off, Universal input x, Digital input x, Maths x  
All active inputs are available for selection.

**Factory setting** Switched off

---

### Density unit

---

**Navigation**  Expert → Application → Maths → Maths x → DP-Flow → Density unit  
Direct access code: 400124-00x  
Examples: Maths 1: 400124-000; Maths 4: 400124-003

**Description** Please select the density unit.  
Only visible if application = DP-Flow liquids or DP-Flow gas

**Selection** kg/m<sup>3</sup>, lb/ft<sup>3</sup>

**Factory setting** kg/m<sup>3</sup>

---

### Design density

---

**Navigation**  Expert → Application → Maths → Maths x → DP-Flow → Design density  
Direct access code: 400125-00x  
Examples: Maths 1: 400125-000; Maths 4: 400125-003

**Description** Density under design conditions (at design pressure/temperature).  
Only visible if type = V-Cone or Gilflo

**User entry** Number (max. 8 characters)

**Factory setting** 1000 (kg/m<sup>3</sup> or lb/ft<sup>3</sup>)

---

### Isentropic exponent

---

**Navigation**  Expert → Application → Maths → Maths x → DP-Flow → Isentropic exponent  
Direct access code: 400128-00x  
Examples: Maths 1: 400128-000; Maths 4: 400128-003

**Description** Input of the kappa isentropic exponent. (Required in order to calculate the expansion number).  
Only visible if application = DP-Flow gas

**User entry** Number (max. 8 characters)

**Factory setting** 1,2

---

**"Viscosity" submenu**

---

<b>Navigation</b>	 Expert → Application → Maths → Maths x → DP-Flow → Viscosity
<b>Description</b>	Input of the viscosity at two support points. (Needed to calculate the Reynolds number and flow coefficient). Only visible if application = DP-Flow liquids or DP-Flow gas

---

**Point 1**



---



---

**Temperature**



---

<b>Navigation</b>	 Expert → Application → Maths → Maths x → DP-Flow → Viscosity → Temperature Direct access code: 400130-00x Examples: Maths 1: 400130-000; Maths 4: 400130-003
<b>Description</b>	Temperature
<b>User entry</b>	Number (max. 8 characters)
<b>Factory setting</b>	0

---

**Viscosity**

---

<b>Navigation</b>	 Expert → Application → Maths → Maths x → DP-Flow → Viscosity → Viscosity Direct access code: 400131-00x Examples: Maths 1: 400131-000; Maths 4: 400131-003
<b>Description</b>	Viscosity at the specified temperature.
<b>User entry</b>	Number (max. 8 characters)
<b>Factory setting</b>	1 cp

---

**Point 2**



---



---

**Temperature**



---

<b>Navigation</b>	 Expert → Application → Maths → Maths x → DP-Flow → Viscosity → Temperature Direct access code: 400135-00x Examples: Maths 1: 400135-000; Maths 4: 400135-003
<b>Description</b>	Temperature
<b>User entry</b>	Number (max. 8 characters)
<b>Factory setting</b>	100

---

### Viscosity

---

<b>Navigation</b>	 Expert → Application → Maths → Maths x → DP-Flow → Viscosity → Viscosity Direct access code: 400136-00x Examples: Maths 1: 400136-000; Maths 4: 400136-003
<b>Description</b>	Viscosity at the specified temperature.
<b>User entry</b>	Number (max. 8 characters)
<b>Factory setting</b>	0.3 cp

---

### "Totalization" submenu

---

<b>Navigation</b>	 Expert → Application → Maths → Maths x → Totalization
<b>Description</b>	Settings only needed if the calculated value - e.g. for quantity calculation - should be integrated. Analysis time frames, see "Signal analysis".

---

### Totalization

---

<b>Navigation</b>	 Expert → Application → Maths → Maths x → Totalization → Totalization Direct access code: 400050-00x Examples: Maths 1: 400050-000; Maths 4: 400050-003
<b>Description</b>	By totalizing the analog signal (e.g. flow rate in m <sup>3</sup> /h) quantities (in m <sup>3</sup> ) can be calculated.
<b>Selection</b>	No, Yes
<b>Factory setting</b>	No

---

### Totalization base

---

<b>Navigation</b>	 Expert → Application → Maths → Maths x → Totalization → Totalization base Direct access code: 400051-00x Examples: Maths 1: 400051-000; Maths 4: 400051-003
<b>Description</b>	Select the required time base. Example: ml/s -> time base seconds (s); m <sup>3</sup> /h -> time base hours (h). Only visible if totalization = Yes
<b>Selection</b>	Second (s), Minute (min), Hour (h), Day (d)
<b>Factory setting</b>	Second (s)

---

### Unit

---

<b>Navigation</b>	 Expert → Application → Maths → Maths x → Totalization → Unit Direct access code: 400052-00x Examples: Maths 1: 400052-000; Maths 4: 400052-003
<b>Description</b>	Enter the unit for the calculated quantity (e.g. "m <sup>3</sup> "). Only visible if totalization = Yes
<b>User entry</b>	Text (max. 6 characters)

---

### Total. eng. unit (option "Energy package")

---

<b>Navigation</b>	 Expert → Application → Maths → Maths x → Totalization → Total. eng. unit Direct access code: 400112-00x Examples: Maths 1: 400112-000; Maths 4: 400112-003
<b>Description</b>	Select the unit of the quantity determined by means of totalization here. Only visible if function = Energy or Mass calculation and totalization = Yes
<b>Selection</b>	kWh, MWh, MJ, GJ, kBtu, MBtu, tonh, therm, kg, t, lbs, ton

---

### Low flow cut off

---

<b>Navigation</b>	 Expert → Application → Maths → Maths x → Totalization → Low flow cut off Direct access code: 400053-00x Examples: Maths 1: 400053-000; Maths 4: 400053-003
-------------------	--

**Description** If the volume flow recorded is below the set value, these quantities are not added to the counter.  
If the input is scaled from 0 to y, or if the pulse input is used, all values that are smaller than the set value are not recorded.  
If the input is scaled from -x to +y, all values around the zero point (e.g. also negative values) are not recorded.  
Only visible if totalization = Yes

**User entry** Number (max. 8 digits)

**Factory setting** 0

---

### Calc. factor

---

**Navigation**  Expert → Application → Maths → Maths x → Totalization → Calc. factor  
Direct access code: 400054-00x  
Examples: Maths 1: 400054-000; Maths 4: 400054-003

**Description** Factor for calculating the integrated value(e.g. the transmitter delivers l/s -> totalization base = second -> engineering unit required is m<sup>3</sup> --> enter factor 0.001)  
Only visible if totalization = Yes

**User entry** Number (max. 8 digits)

**Factory setting** 1.0

---

### Totalizer (Online configuration)

---

**Navigation**  Expert → Application → Maths → Maths x → Totalization → Totalizer  
Direct access code: 400055-00x  
Examples: Maths 1: 400055-000; Maths 4: 400055-003

**Description** Initial setting for the totalizer. Useful when continuing measurements recorded to date with an (electro)-mechanical counter.  
Only visible if totalization = Yes

**User entry** Number (max. 15 digits)

**Factory setting** 0

---

### "Linearization" submenu

---

**Navigation**  Expert → Application → Maths → Maths x → Linearization

**Description** Linearization settings.  
Only visible if function = Formula editor

---

**Linearization**



---

<b>Navigation</b>	 Expert → Application → Maths → Maths x → Linearization → Linearization Direct access code: 400301-00x Examples: Maths 1: 400301-000; Maths 4: 400301-003
<b>Description</b>	Specify whether this input should be linearized.
<b>Selection</b>	No, Yes
<b>Factory setting</b>	No

---

**Number of points**



---

<b>Navigation</b>	 Expert → Application → Maths → Maths x → Linearization → Number of points Direct access code: 400302-00x Examples: Maths 1: 400302-000; Maths 4: 400302-003
<b>Description</b>	Specify how many support points your linearization table has. Note: The first and last point must always correspond to the start and end of the measuring range respectively.
<b>User entry</b>	2 to 32
<b>Factory setting</b>	2

---

**Dim. linearized value**



---

<b>Navigation</b>	 Expert → Application → Maths → Maths x → Linearization → Dim. linearized value Direct access code: 400303-00x Examples: Maths 1: 400303-000; Maths 4: 400303-003
<b>Description</b>	Unit/dimension for the linearized value. Note: The first and last point must always correspond to the start and end of the measuring range respectively.
<b>User entry</b>	Text (max. 6 characters)

---

**Zoom start**

---

<b>Navigation</b>	 Expert → Application → Maths → Maths x → Linearization → Zoom start Direct access code: 400304-00x Examples: Maths 1: 400304-000; Maths 4: 400304-003
-------------------	---

<b>Description</b>	If the total transmitter range is not used, you can enter the lower value of the required section here (higher resolution). Example: Transmitter 0-14 pH, required section: 5-9 pH. Set "5" here. The zoom has no influence on the storage.
<b>User entry</b>	Number (max. 8 characters)
<b>Factory setting</b>	0

---

### Zoom end

---

<b>Navigation</b>	 Expert → Application → Maths → Maths x → Linearization → Zoom end Direct access code: 400305-00x Examples: Maths 1: 400305-000; Maths 4: 400305-003
<b>Description</b>	Like "Zoom start". Enter the upper value of the required range here. Example: Transmitter 0-14 pH, required section: 5-9 pH. Here: "9".
<b>User entry</b>	Number (max. 8 characters)
<b>Factory setting</b>	100

---

### "Points" submenu

---

<b>Navigation</b>	 Expert → Application → Maths → Maths x → Linearization → Points
<b>Description</b>	Enter the support points of the linearization table here. Note: The first and last point must always correspond to the start and end of the measuring range respectively. The support points can only be viewed in the PC software here. To change the support points use the "Edit table" switch.

---

### Check table

---

<b>Navigation</b>	 Expert → Application → Maths → Maths x → Linearization → Points → Check table Direct access code: 400306-00x Examples: Maths 1: 400306-000; Maths 4: 400306-003
<b>Description</b>	Here you can check whether the linearization table has been entered correctly.
<b>Selection</b>	No, Yes
<b>Factory setting</b>	No

---

### Sort table

---

<b>Navigation</b>	 Expert → Application → Maths → Maths x → Linearization → Points → Sort table Direct access code: 400307-00x Examples: Maths 1: 400307-000; Maths 4: 400307-003
<b>Description</b>	You can sort the linearization table here.
<b>Selection</b>	No, Yes
<b>Factory setting</b>	No

---

### x-value (1 to 32)

---

<b>Navigation</b>	 Expert → Application → Maths → Maths x → Linearization → Points → x-value (1 to 32) Direct access code, x-value 1: 400310-00x Direct access code, x-value 2: 400312-00x Examples: Maths 1, x-value 1: 400310-000; Maths 4: 400310-003
<b>Description</b>	x-value for the linearization (value from the device input). e.g. 10 cm corresponds to 20 liters --> enter 10.
<b>User entry</b>	Number (max. 8 characters)
<b>Factory setting</b>	0

---

### y-value (1 to 32)

---

<b>Navigation</b>	 Expert → Application → Maths → Maths x → Linearization → Points → y-value (1 to 32) Direct access code, y-value 1: 400311-00x Direct access code, y-value 2: 400313-00x Examples: Maths 1, y-value 1: 400311-000; Maths 4: 400311-003
<b>Description</b>	Enter the y-value that the measured x-value corresponds to e.g. 10 cm corresponds to 20 liters --> enter 20.
<b>User entry</b>	Number (max. 8 characters)
<b>Factory setting</b>	0

---

### "Fault mode" submenu

---

<b>Navigation</b>	 Expert → Application → Maths → Maths x → Fault mode
<b>Description</b>	Contains settings that define how this channel is to react under fault conditions (e.g. if an input channel has a cable open circuit or there is division by 0).



---

**Wet steam alarm**



---

<b>Navigation</b>	 Expert → Application → Maths → Maths x → Fault mode → Wet steam alarm Direct access code: 400113-00x Examples: Maths 1: 400113-000; Maths 4: 400113-003
<b>Description</b>	Condensation of steam! Process temperature = saturated steam temperature = condensate temperature. Only visible if application = Steam heat quantity or Steam heat difference
<b>Selection</b>	Counter stop, Saturated steam calculation
<b>Factory setting</b>	Counter stop

---

**On error**



---

<b>Navigation</b>	 Expert → Application → Maths → Maths x → Fault mode → On error Direct access code: 400060-00x Examples: Maths 1: 400060-000; Maths 4: 400060-003
<b>Description</b>	Configure what value the device should continue working with (for calculations) if the measured value is not valid (e.g. cable open circuit).
<b>Selection</b>	Invalid calculation, Error value
<b>Factory setting</b>	Invalid calculation

---

**Error value**



---

<b>Navigation</b>	 Expert → Application → Maths → Maths x → Fault mode → Error value Direct access code: 400061-00x Examples: Maths 1: 400061-000; Maths 4: 400061-003
<b>Description</b>	The device continues calculating with this value in the event of an error. Only visible if on error = Error value
<b>User entry</b>	Number (max. 8 digits)
<b>Factory setting</b>	0

---

**Copy settings**



---

<b>Navigation</b>	 Expert → Application → Maths → Maths x → Copy settings Direct access code: 400200-00x Examples: Maths 1: 400200-000; Maths 4: 400200-003
<b>Description</b>	Copies settings from actual channel to selected channel.
<b>Selection</b>	No, In maths. channel x Users can choose from all the available maths channels.
<b>Factory setting</b>	No

---

### "Signal analysis" submenu



---

<b>Navigation</b>	 Expert → Application → Signal analysis
<b>Description</b>	Contains settings for signal analysis (saving).

---

### Analysis x

---

<b>Navigation</b>	 Expert → Application → Signal analysis → Analysis x Direct access code: 44000x-000 Examples: Analysis 1: 440000-000; Analysis 4: 440003-000
<b>Description</b>	For the set time frame, determines the minimum, maximum and average value or quantities and operating times.  If the "Controlled externally" option is to be used, a digital input or a maths channel must be set to "Function = Control input" and "Action = Start/stop analysis x".
<b>Selection</b>	Switched off, Controlled externally, 1min, 2min, 3min, 4min, 5min, 10min, 15min, 30min, 1h, 2h, 3h, 4h, 6h, 8h, 12h Daily analysis, Weekly analysis, Monthly analysis, Annual analysis
<b>Factory setting</b>	Switched off

---

### Synchron. time

---

<b>Navigation</b>	 Expert → Application → Signal analysis → Synchron. time Direct access code: 440004-000
<b>Description</b>	Time for completing the signal analysis. If, for example, 07:00 is set up, then the daily analysis will run from 07:00 of the actual day until 07:00 of the following day.
<b>User entry</b>	Time
<b>Factory setting</b>	00:00

---

**Week starting on**



---

<b>Navigation</b>	 Expert → Application → Signal analysis → Week starting on Direct access code: 440005-000
<b>Description</b>	Configure what day the weekly analysis should start. Only visible if at least one analysis = Weekly analysis
<b>Selection</b>	Sunday, Monday, Tuesday, Wednesday, Thursday, Friday, Saturday
<b>Factory setting</b>	Monday

---

**Alarm statistics ("Telealarm" option)**



---

<b>Navigation</b>	 Expert → Application → Signal analysis → Alarm statistics Direct access code: 440006-000
<b>Description</b>	The following data can be determined via the signal analysis cycles (e.g. daily analysis): <ul style="list-style-type: none"> <li>■ How often was the set point violated</li> <li>■ How long was the set point violated</li> </ul>
<b>Selection</b>	No, Yes
<b>Factory setting</b>	No

---

**Group days ("Telealarm" option)**

---

<b>Navigation</b>	 Expert → Application → Signal analysis → Group days Direct access code: 440008-000
<b>Description</b>	Set up how often the weekly- monthly- or yearly analysis are to be calculated. "No": Each individual alarm is counted. "Yes": The number of days within the analysis cycle in which at least one alarm took place (e.g. required for the number of overflows in a storm overflow tank).
<b>Selection</b>	No, Yes
<b>Factory setting</b>	No

---

**Reset to zero**  
(Online configuration)

---

<b>Navigation</b>	 Expert → Application → Signal analysis → Reset to zero Direct access code: 440007-000
-------------------	--

<b>Description</b>	Reset analysis. Note: Should only be executed after the device has taken over the setup.
<b>Selection</b>	Please select, Analysis x, Totalizer, All
<b>Factory setting</b>	Please select

---

### Reset channel (Online configuration)



---

<b>Navigation</b>	 Expert → Application → Signal analysis → Reset channel Direct access code: 440010-000
<b>Description</b>	Reset analysis of a single channel. Note: Should only be executed after the device has taken over the setup.
<b>Selection</b>	Please select, Universal input x, Digital input x, Maths x, Limit x, Relay x All active inputs are available for selection.
<b>Factory setting</b>	Please select

---

### "Automatic printout" submenu



---

<b>Navigation</b>	 Expert → Application → Signal analysis → Automatic printout
<b>Description</b>	Specify whether an automatic print-out should follow at the end of an evaluation.  The printout is only made if a USB printer is connected to the device or a network printer is available. For supported printers please refer to the Operating Instructions. If the Batch option is selected, the printout is configured in the Batch mode/Print menu.

---

### Analysis x

---

<b>Navigation</b>	 Expert → Application → Signal analysis → Automatic printout → Analysis x Direct access code, analysis 1: 440020-000 Direct access code, analysis 2: 440021-000 Direct access code, analysis 3: 440022-000 Direct access code, analysis 4: 440023-000
<b>Description</b>	Specify whether an automatic print-out should follow at the end of an evaluation.  The print-out is only made if a USB printer is connected to the device! For supported printers please refer to the Operating Instructions. If the Batch option is selected, the printout is configured in the Batch mode/Print menu.
<b>Selection</b>	No, Yes

**Factory setting** No

---

### "Limits" submenu

---

**Navigation**  Expert → Application → Limits

**Description** Limit values can monitor the measured values. A relay, for example, can be switched if a limit value is violated.

---

### Add limit value

---

**Navigation**  Expert → Application → Limits → Add limit value  
Direct access code: 450300-000

**Description** Adding a new limit value.

**Selection** No, Yes

**Factory setting** No

---

### Delete limit value

---

**Navigation**  Expert → Application → Limits → Delete limit value  
Direct access code: 450301-000

**Description** Deleting a limit value from the list.

**Selection** No, Limit value x

**Factory setting** No

---

### Change limits

 This function is **not** supported by the **DIN rail version**.

---

**Navigation**  Expert → Application → Limits → Change limits  
Direct access code: 450100-000

**Description** Specify where the limit values can be changed. If you select "Outside of setup also", you can change limit values in the "Operation" menu as well as in "Setup". This allows you to adjust your limit values to the process even if setup is locked.  
Note: This function can/should be protected by the limit value code.

**Selection** Only in setup, Outside of setup also

**Factory setting** Only in setup

---

### "Limit x" submenu

---

**Navigation**  Expert → Application → Limits → Limit x

**Description** View or change the setup for the selected alarm set point.

 x = place holder for selected limit value

---

### Channel/value

---

**Navigation**  Expert → Application → Limits → Limit x → Channel/value  
Direct access code: 450000-0xx  
Examples: Limit 1: 450000-000; Limit 30: 450000-029

**Description** Select which input/calculated value the limit value refers to.

**Selection** Switched off, Universal input x, Digital input x, Maths x, Limit x

**Factory setting** Switched off

---

### Type

---

**Navigation**  Expert → Application → Limits → Limit x → Type  
Direct access code: 450001-0xx  
Examples: Limit 1: 450001-000; Limit 30: 450001-029

**Description** Type of limit value (depends on the input variable).

**Selection** Switched off, Upper set point, Lower set point, Analysis x, Gradient dy/dt, Analysis x frequency, Analysis x duration, Inband, Outband

Description of the individual set point types

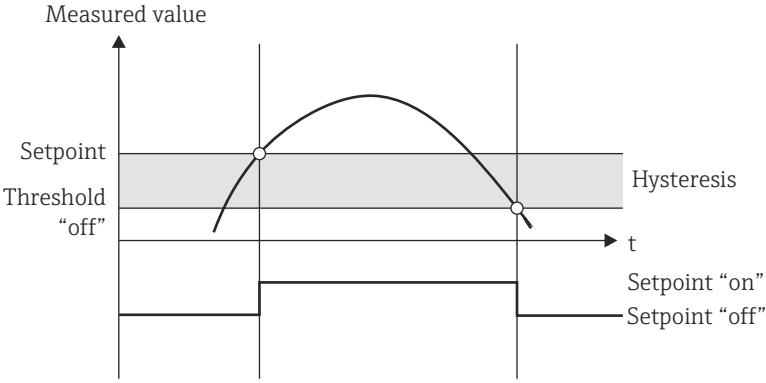
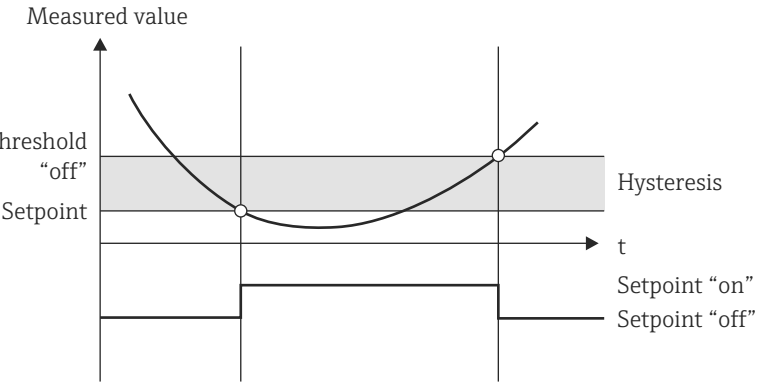
Set point type/function	Description
Hysteresis	<p>For every set point, the switch point can be controlled via a hysteresis.                      The hysteresis is set as an absolute value (only positive values) in the unit of the respective channel (e.g. upper set point = 100 m, hysteresis = 1 m: set point on = 100 m, set point off = 99 m)</p>
Upper set point	<p>The limit value is active if the value exceeds the configured value. The limit value is switched off if the limit value, including hysteresis, is undershot.</p>  <p>The graph shows a measured value curve that rises above a setpoint and then falls below it. A shaded gray band between the setpoint and a higher threshold represents the hysteresis. The control signal (Setpoint "on"/"off") is high when the measured value is above the setpoint and low when it is below the hysteresis band. Labels include: Measured value, Setpoint, Threshold "off", Hysteresis, t, Setpoint "on", and Setpoint "off".</p> <p style="text-align: right; font-size: small;">A0010187-EN</p>
Lower set point	<p>The limit is active if the value drops below the configured value. The limit value is switched off if the limit value, including hysteresis, is exceeded.</p>  <p>The graph shows a measured value curve that falls below a setpoint and then rises above it. A shaded gray band between the setpoint and a lower threshold represents the hysteresis. The control signal (Setpoint "on"/"off") is high when the measured value is below the setpoint and low when it is above the hysteresis band. Labels include: Measured value, Threshold "off", Setpoint, Hysteresis, t, Setpoint "on", and Setpoint "off".</p> <p style="text-align: right; font-size: small;">A0010186-EN</p>

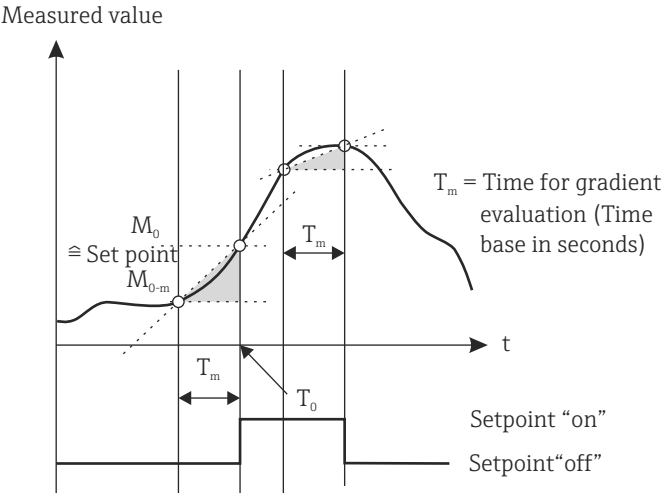
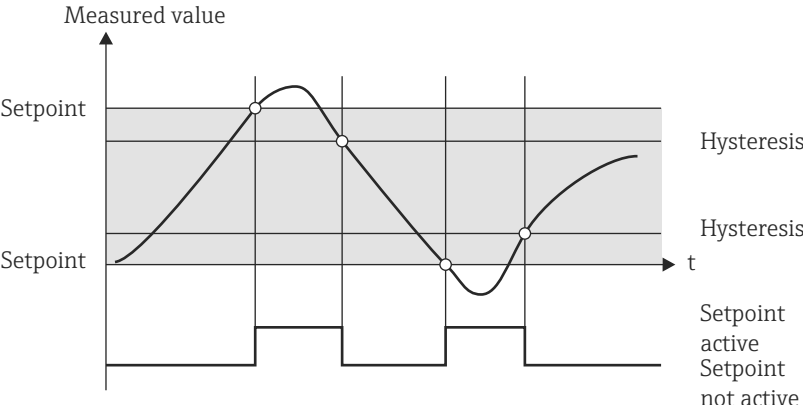
Set point type/function	Description
<p>Gradient dy/dt</p>	<p>The "Gradient" operating mode is used to monitor the temporal change of the input signal. The alarm is triggered if the measured value reaches or exceeds the preset value.</p> <p>If a positive value is set, the limit value is monitored from increasing gradients. In the case of negative values the decreasing gradient is monitored.</p> <p>The alarm is canceled when the gradient drops below the preset value. A hysteresis is not possible in the Gradient operating mode. The alarm can be suppressed for the set time delay (unit: seconds s) in order to decrease the sensitivity.</p> <p>Measured value</p>  <p><math>M_0</math> ≅ Set point <math>M_{0-m}</math></p> <p><math>T_m</math> = Time for gradient evaluation (Time base in seconds)</p> <p><math>T_0</math></p> <p>Setpoint "on" Setpoint "off"</p> <p style="text-align: right;">A0010188-EN</p>
<p>Inband</p>	<p>The limit value is violated as soon as the measured value to be checked exceeds or drops below a preset maximum or minimum respectively. The hysteresis must be monitored on the inside of the band. For the limit value to no longer be violated, the value must lie within the hysteresis range.</p> <p>Measured value</p>  <p>Setpoint</p> <p>Hysteresis</p> <p>Hysteresis</p> <p>Setpoint</p> <p>Setpoint active Setpoint not active</p> <p style="text-align: right;">A0010192-EN</p>

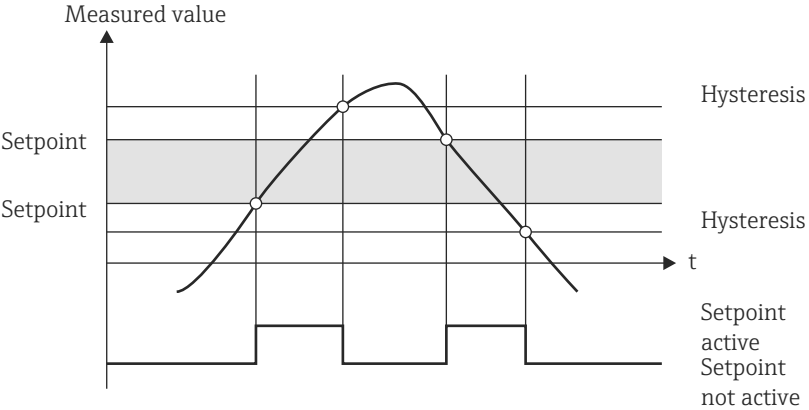
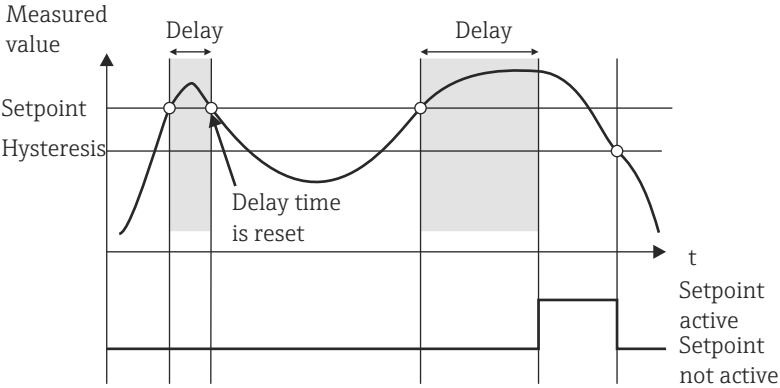

Set point type/function	Description
<p>Outband</p>	<p>The limit value is violated as soon as the measured value to be checked lies within a preset band between minimum and maximum. The hysteresis must be monitored on the outside of the band. For the limit value to no longer be violated, the value must lie outside of the hysteresis range.</p>  <p style="text-align: right;">A0010189-EN</p>
<p>Special case: Hysteresis and delay for one limit value</p>	<p>In the special case in which the hysteresis and limit value delay are activated, a limit value is switched according to the following principle. If the hysteresis and the limit value delay are activated, the delay becomes active when a limit value is exceeded and measures the time from which the value is exceeded. If the measured value falls below the limit value, the delay is reset. This also occurs if the measured value falls below the limit value, but continues to be higher than the set hysteresis value. When the limit value is exceeded again, the delay time becomes active again and starts measuring from 0.</p>  <p style="text-align: right;">A0010193-EN</p>

**Factory setting**                      Switched off

**Identifier**

**Navigation**                       Expert → Application → Limits → Limit x → Identifier  
 Direct access code: 450015-0xx  
 Examples: Limit 1: 450015-000; Limit 30: 450015-029

**Description**                      Name of the limit for identification purposes.

**User entry**                      Text (max. 16 characters)

**Factory setting**                      Limit x

---

**Set point**



---

<b>Navigation</b>	 Expert → Application → Limits → Limit x → Set point Direct access code: 450003-0xx Examples: Limit 1: 450003-000; Limit 30: 450003-029
<b>Description</b>	Limit value in the set process unit, e.g. in °C, m <sup>3</sup> /h
<b>User entry</b>	Number (max. 10 digits)
<b>Factory setting</b>	0

---

**Set point 2**



---

<b>Navigation</b>	 Expert → Application → Limits → Limit x → Set point 2 Direct access code: 450017-0xx Examples: Limit 1: 450017-000; Limit 30: 450017-029
<b>Description</b>	Enter the upper limit value for the band. Only visible if type = Inband or Outband
<b>User entry</b>	Number (max. 8 digits)
<b>Factory setting</b>	0

---

**Time span dt**



---

<b>Navigation</b>	 Expert → Application → Limits → Limit x → Time span dt Direct access code: 450014-0xx Examples: Limit 1: 450014-000; Limit 30: 450014-029
<b>Description</b>	Time span within which the signal must change by the specified value before it is recognized as a set point. Note: max. 60 seconds. Only visible if type = Gradient dy/dt
<b>User entry</b>	0 to 60 s
<b>Factory setting</b>	60 s

---

**Hysteresis (abs.)**



---

<b>Navigation</b>	 Expert → Application → Limits → Limit x → Hysteresis (abs.) Direct access code: 450004-0xx Examples: Limit 1: 450004-000; Limit 30: 450004-029
<b>Description</b>	The alarm condition is only canceled when the signal has changed into the normal operation range by the preset value.
<b>User entry</b>	Number (max. 8 digits)
<b>Factory setting</b>	0

---

### Time delay

---

<b>Navigation</b>	 Expert → Application → Limits → Limit x → Time delay Direct access code: 450005-0xx Examples: Limit 1: 450005-000; Limit 30: 450005-029
<b>Description</b>	In order to be interpreted as an alarm the signal must exceed or undercut the preset value by at least the time set up.
<b>User entry</b>	0 to 99999 s
<b>Factory setting</b>	0 s

---

### Switches

---

<b>Navigation</b>	 Expert → Application → Limits → Limit x → Switches Direct access code: 450006-0xx Examples: Limit 1: 450006-000; Limit 30: 450006-029
<b>Description</b>	Switches the appropriate output in the limit value state.
<b>Selection</b>	Not used, Relay x
<b>Factory setting</b>	Not used

---

### LV messages

---

<b>Navigation</b>	 Expert → Application → Limits → Limit x → LV messages Direct access code: 450007-0xx Examples: Limit 1: 450007-000; Limit 30: 450007-029
-------------------	--

**Description** "Do not acknowledge": Alarm condition is signaled by highlighting the tag name in red (no message is output).  
"Acknowledge": In the event of an alarm, a message is also displayed. This message then has to be acknowledged.



Note: In the case of the DIN rail version, the message can only be acknowledged via the Web server!

**Selection** Do not acknowledge, Acknowledge

**Factory setting** Do not acknowledge

---

### Save event

---

**Navigation**  Expert → Application → Limits → Limit x → Save event  
Direct access code: 450008-0xx  
Examples: Limit 1: 450008-000; Limit 30: 450008-029

**Description** Stores a message in the event log on limit value violation.

**Selection** No, Yes, only "On" message

**Factory setting** Yes

---

### Event text LV on

---

**Navigation**  Expert → Application → Limits → Limit x → Event text LV on  
Direct access code: 450009-0xx  
Examples: Limit 1: 450009-000; Limit 30: 450009-029

**Description** This text (including date and time) is shown on the display and/or stored in the event log. Only available if "LV messages" is set to "Acknowledge" or "Save message" is set to "Yes". If no text is entered, the device generates its own text (e.g. Analog 1 > 100%).

**User entry** Text (max. 22 characters)

---

### Event text LV off

---

**Navigation**  Expert → Application → Limits → Limit x → Event text LV off  
Direct access code: 450010-0xx  
Examples: Limit 1: 450010-000; Limit 30: 450010-029

**Description** The same as "Event text LV on", but on return from alarm to normal condition.

**User entry** Text (max. 22 characters)

---

**Record duration of LV on**



---

<b>Navigation</b>	 Expert → Application → Limits → Limit x → Record duration of LV on Direct access code: 450011-0xx Examples: Limit 1: 450011-000; Limit 30: 450011-029
<b>Description</b>	The duration of a set point violation can be recorded. The duration is appended to the "Limit value off" event text (format: <hhhh>h<mm>:<ss>). Power failure times do not affect the duration. If the set point was violated before the power failure and is still violated after the power failure, the duration continues.
<b>Selection</b>	No, Yes
<b>Factory setting</b>	No

---

**Reset relay**



---

<b>Navigation</b>	 Expert → Application → Limits → Limit x → Reset relay Direct access code: 450016-0xx Examples: Limit 1: 450016-000; Limit 30: 450016-029
<b>Description</b>	If LV no longer violated: the relay is switched as long as the set point is violated. After acknowledging message: even if the set point is no longer violated, the relay remains switched until the message has been acknowledged. If the set point is still violated when the message is acknowledged, the relay stays switched until the set point is no longer violated. Up to message acknowledgment: the relay remains active until the message is acknowledged or the set point is no longer active.
<b>Selection</b>	If LV no longer violated, After acknowledging message, Up to message acknowledgment
<b>Factory setting</b>	If LV no longer violated

---

**Save cycle**

---

<b>Navigation</b>	 Expert → Application → Limits → Limit x → Save cycle Direct access code: 450012-0xx Examples: Limit 1: 450012-000; Limit 30: 450012-029
<b>Description</b>	Normal: Save in normal store cycle. Alarm cycle: Fast storage during an alarm violation, e.g. every second. Caution: Requires higher memory capacity!  <ul style="list-style-type: none"> <li>▪ The save cycle is set under signal groups .</li> <li>▪ In the event of an alarm violation, all the groups are saved in the alarm cycle.</li> </ul>
<b>Selection</b>	Normal, Alarm cycle

**Factory setting** Normal

---

### Draw help line

 This function is **not** supported by the **DIN rail version**.

**Navigation**  Expert → Application → Limits → Limit x → Draw help line  
 Direct access code: 450013-0xx  
 Examples: Limit 1: 450013-000; Limit 30: 450013-029

**Description** The user can configure whether this set point should be displayed in the graphic as a help line (in the color of the channel).  
 Note: 4 lines can be shown per channel in a single group.

**Selection** No, Yes

**Factory setting** No

---

### Copy settings

**Navigation**  Expert → Application → Limits → Limit x → Copy settings  
 Direct access code: 450200-0xx  
 Examples: Limit 1: 450200-000; Limit 30: 450200-029

**Description** Copies settings from actual channel to selected channel.

**Selection** No, In limit x (all the limit values are displayed)

**Factory setting** No

---

### "Batch mode" submenu (option)

**Navigation**  Expert → Application → Batch mode

**Description** Contains settings for the batch mode.



 Detailed descriptions of this device option can be found in the associated documentation.

---

### "Signal groups" submenu

**Navigation**  Expert → Application → Signal groups

**Description** Group the analog, digital and/or mathematics channels such that you can call up important information during operation (e.g. temperatures, signals in plant unit 1).

-  Maximum 8 channels per group!
-  High speed storage (100ms) is only available in group 1.

---

### "Group x" submenu

---

**Navigation**  Expert → Application → Signal groups → Group x

**Description**  x = place holder for selected group

General settings for displaying the measured value and saving data.

---

### Identifier

---

**Navigation**  Expert → Application → Signal groups → Group x → Identifier  
 Direct access code: 460000-0xx  
 Examples: Group 1: 460000-000; Group 4: 460000-003

**Description** Enter a name for these groups.

**User entry** Text (max. 20 characters)

**Factory setting** Group x

---

### Save cycle

---

**Navigation**  Expert → Application → Signal groups → Group x → Save cycle  
 Direct access code: 460001-0xx  
 Examples: Group 1: 460001-000; Group 4: 460001-003

**Description** Configure the save cycle with which this group should be saved in normal conditions (see also set point/save cycle).

 The save cycle is independent of the measured value display (see Operating Instructions).

**Selection** Off, 100ms (only for group 1), 1s, 2s, 3s, 4s, 5s, 10s, 15s, 20s, 30s, 1min, 2min, 3min, 4min, 5min, 10min, 15min, 30min, 1h

**Factory setting** 1min

---

### Alarm cycle

---

<b>Navigation</b>	 Expert → Application → Signal groups → Group x → Alarm cycle Direct access code: 460002-0xx Examples: Group 1: 460002-000; Group 4: 460002-003
<b>Description</b>	Configure the save cycle with which this group should be saved in an alarm condition (limit value violation). Caution: Requires higher memory capacity.
<b>Selection</b>	Off, 100ms (only for group 1), 1s, 2s, 3s, 4s, 5s, 10s, 15s, 20s, 30s, 1min, 2min, 3min, 4min, 5min, 10min, 15min, 30min, 1h
<b>Factory setting</b>	1min

---

### Display blue



---

<b>Navigation</b>	 Expert → Application → Signal groups → Group x → Display blue Direct access code: 460003-00x Examples: Group 1: 460003-000; Group 4: 460003-003
<b>Description</b>	Choose which input/calculated variable should be displayed in this group.
<b>Selection</b>	Switched off, Universal input x, Digital input x, Maths x
<b>Factory setting</b>	Switched off

---

### Display

---

<b>Navigation</b>	 Expert → Application → Signal groups → Group x → Display Direct access code: 460004-00x Examples: Group 1: 460004-000; Group 4: 460004-003
<b>Description</b>	Please select which data from the selected channel should be displayed.  If the "Everything" option is selected, the device switches cyclically between the various values of the channel (instantaneous value, analysis 1 etc.)
<b>Selection</b>	Instantaneous value/state, Analysis x, Totalizer, Everything
<b>Factory setting</b>	Instantaneous value/state

---

### Display black

---

<b>Navigation</b>	 Expert → Application → Signal groups → Group x → Display black Direct access code: 460005-00x Examples: Group 1: 460005-000; Group 4: 460005-003
<b>Description</b>	Choose which input/calculated variable should be displayed in this group.



**Selection** Switched off, Universal input x, Digital input x, Maths x

**Factory setting** Switched off

---

### Display

---

**Navigation**  Expert → Application → Signal groups → Group x → Display  
Direct access code: 460006-0xx  
Examples: Group 1: 460006-000; Group 4: 460006-003

**Description** Please select which data from the selected channel should be displayed.

**Selection** Instantaneous value/state, Analysis x, Totalizer, Everything

**Factory setting** Instantaneous value/state

---

### Display red

---

**Navigation**  Expert → Application → Signal groups → Group x → Display red  
Direct access code: 460007-00x  
Examples: Group 1: 460007-000; Group 4: 460007-003

**Description** Choose which input/calculated variable should be displayed in this group.

**Selection** Switched off, Universal input x, Digital input x, Maths x

**Factory setting** Switched off

---

### Display

---

**Navigation**  Expert → Application → Signal groups → Group x → Display  
Direct access code: 460008-0xx  
Examples: Group 1: 460008-000; Group 4: 460008-003

**Description** Please select which data from the selected channel should be displayed.

**Selection** Instantaneous value/state, Analysis x, Totalizer, Everything

**Factory setting** Instantaneous value/state

---

### Display green

---

<b>Navigation</b>	 Expert → Application → Signal groups → Group x → Display green Direct access code: 460009-00x Examples: Group 1: 460009-000; Group 4: 460009-003
<b>Description</b>	Choose which input/calculated variable should be displayed in this group.
<b>Selection</b>	Switched off, Universal input x, Digital input x, Maths x
<b>Factory setting</b>	Switched off

---

### Display

---

<b>Navigation</b>	 Expert → Application → Signal groups → Group x → Display Direct access code: 460010-0xx Examples: Group 1: 460010-000; Group 4: 460010-003
<b>Description</b>	Please select which data from the selected channel should be displayed.
<b>Selection</b>	Instantaneous value/state, Analysis x, Totalizer, Everything
<b>Factory setting</b>	Instantaneous value/state

---

### Display violet

---

<b>Navigation</b>	 Expert → Application → Signal groups → Group x → Display violet Direct access code: 460011-00x Examples: Group 1: 460011-000; Group 4: 460011-003
<b>Description</b>	Choose which input/calculated variable should be displayed in this group.
<b>Selection</b>	Switched off, Universal input x, Digital input x, Maths x
<b>Factory setting</b>	Switched off

---

### Display

---

<b>Navigation</b>	 Expert → Application → Signal groups → Group x → Display Direct access code: 460012-0xx Examples: Group 1: 460012-000; Group 4: 460012-003
<b>Description</b>	Please select which data from the selected channel should be displayed.
<b>Selection</b>	Instantaneous value/state, Analysis x, Totalizer, Everything
<b>Factory setting</b>	Instantaneous value/state

---

**Display orange**



---

<b>Navigation</b>	 Expert → Application → Signal groups → Group x → Display orange Direct access code: 460013-00x Examples: Group 1: 460013-000; Group 4: 460013-003
<b>Description</b>	Choose which input/calculated variable should be displayed in this group.
<b>Selection</b>	Switched off, Universal input x, Digital input x, Maths x
<b>Factory setting</b>	Switched off

---

**Display**



---

<b>Navigation</b>	 Expert → Application → Signal groups → Group x → Display Direct access code: 460014-0xx Examples: Group 1: 460014-000; Group 4: 460014-003
<b>Description</b>	Please select which data from the selected channel should be displayed.
<b>Selection</b>	Instantaneous value/state, Analysis x, Totalizer, Everything
<b>Factory setting</b>	Instantaneous value/state

---

**Display cyan**



---

<b>Navigation</b>	 Expert → Application → Signal groups → Group x → Display cyan Direct access code: 460015-00x Examples: Group 1: 460015-000; Group 4: 460015-003
<b>Description</b>	Choose which input/calculated variable should be displayed in this group.
<b>Selection</b>	Switched off, Universal input x, Digital input x, Maths x
<b>Factory setting</b>	Switched off

---

**Display**

---

<b>Navigation</b>	 Expert → Application → Signal groups → Group x → Display Direct access code: 460016-0xx Examples: Group 1: 460016-000; Group 4: 460016-003
<b>Description</b>	Please select which data from the selected channel should be displayed.

**Selection** Instantaneous value/state, Analysis x, Totalizer, Everything

**Factory setting** Instantaneous value/state

---

### Display brown

---

**Navigation**  Expert → Application → Signal groups → Group x → Display brown  
Direct access code: 460017-00x  
Examples: Group 1: 460017-000; Group 4: 460017-003

**Description** Choose which input/calculated variable should be displayed in this group.

**Selection** Switched off, Universal input x, Digital input x, Maths x

**Factory setting** Switched off

---

### Display

---

**Navigation**  Expert → Application → Signal groups → Group x → Display  
Direct access code: 460018-0xx  
Examples: Group 1: 460018-000; Group 4: 460018-003

**Description** Please select which data from the selected channel should be displayed.

**Selection** Instantaneous value/state, Analysis x, Totalizer, Everything

**Factory setting** Instantaneous value/state

---

### Grid divisions

---

**Navigation**  Expert → Application → Signal groups → Group x → Grid divisions  
Direct access code: 460019-0xx  
Examples: Group 1: 460019-000; Group 4: 460019-003

**Description** Indicates the number of lines ("amplitude grid") that should be displayed. Example: display of 0 to 100%: select 10 divisions, display 0 to 14pH: select 14 divisions.

**Selection** Logarithmic, 1, 2, 3, 4, 5, 6, 7, 8, 9, 10, 11, 12, 13, 14, 15, 16, 17, 18, 19, 20

**Factory setting** 10

---

### Min. decade

---

<b>Navigation</b>	 Expert → Application → Signal groups → Group x → Min. decade Direct access code: 460020-0xx Examples: Group 1: 460020-000; Group 4: 460020-003
<b>Description</b>	Set the decade from which the display should be split.
<b>Selection</b>	1, 10, 100, 1000, 10000, 100000, 1000000, 10000000
<b>Factory setting</b>	1

---

### Max. decade

---

<b>Navigation</b>	 Expert → Application → Signal groups → Group x → Max. decade Direct access code: 460021-0xx Examples: Group 1: 460021-000; Group 4: 460021-003
<b>Description</b>	Set the decade up to which the display should be split.
<b>Selection</b>	1, 10, 100, 1000, 10000, 100000, 1000000, 10000000
<b>Factory setting</b>	10000

---

### Curve display

 This function is **not** supported by the **DIN rail version**.

---

<b>Navigation</b>	 Expert → Application → Signal groups → Group x v Curve display Direct access code: 460022-0xx Examples: Group 1: 460022-000; Group 4: 460022-003
<b>Description</b>	The instantaneous values are displayed as standard for the measured value curves. Alternatively, this current value display can also be disabled which means that more data can be shown on the display as a result.
<b>Selection</b>	No instantaneous values, With instantaneous values
<b>Factory setting</b>	With instantaneous values

---

### Curve display

 This function is **not** supported by the **DIN rail version**.

---

<b>Navigation</b>	 Expert → Application → Signal groups → Group x → Curve display Direct access code: 460023-0xx Examples: Group 1: 460023-000; Group 4: 460023-003
-------------------	--

**Description** Configure the background color for the curve display.

**Selection** White background, Black background

**Factory setting** White background

---

### Zoom

 This function is **not** supported by the **DIN rail version**.

**Navigation**  Expert → Application → Signal groups → Group x → Zoom  
Direct access code: 460028-0xx  
Examples: Group 1: 460028-000; Group 4: 460028-003

**Description** Defines the zoom that is shown in "Curves" or "Waterfall" display mode. This setting does not affect other display modes (e.g. Curves in range, Bar graph etc.).

**Selection** Do not display, Scroll display, Display blue, Display black, Display red, Display green, Display violet, Display orange, Display cyan, Display brown

**Factory setting** Do not display

---

### Bargraph

 This function is **not** supported by the **DIN rail version**.

**Navigation**  Expert → Application → Signal groups → Group x → Bargraph  
Direct access code: 460024-0xx  
Examples: Group 1: 460024-000; Group 4: 460024-003

**Description** Configure the direction in which the bar graphs should be drawn.

**Selection** Vertical (bottom->top), Vertical (top->bottom), Horizontal (left->right), Horizontal (right->left), Centered/vertical, Centered/horizontal

**Factory setting** Vertical (bottom->top)

---

### Batch assignment (option)

**Navigation**  Expert → Application → Signal groups → Group x → Batch assignment  
Direct access code: 460025-0xx  
Examples: Group 1: 460025-000; Group 4: 460025-003

<b>Description</b>	Configure what batch this group belongs to.  <ul style="list-style-type: none"> <li>▪ Channels can be assigned to multiple batches/groups.</li> <li>▪ Only relevant for batch printout.</li> </ul>
<b>Selection</b>	Do not assign any batch, Assign all batches, Batch x
<b>Factory setting</b>	Assign all batches

---

### Save group (Batch option)

---

<b>Navigation</b>	 Expert → Application → Signal groups → Group x → Save group Direct access code: 460026-0xx Examples: Group 1: 460026-000; Group 4: 460026-003
<b>Description</b>	The group will always be saved or only when the allocated batch is active.
<b>Selection</b>	Only when batch is active, Always
<b>Factory setting</b>	Always

---

### "Circular chart" submenu

 This function is **not** supported by the **DIN rail version**.

---

<b>Navigation</b>	 Expert → Application → Signal groups → Group x → Circular chart
<b>Description</b>	Contains settings for the circular chart.

---

### 1 revolution =

---



<b>Navigation</b>	 Expert → Application → Signal groups → Group x → Circular chart → 1 revolution = Direct access code: 460027-0xx Examples: Group 1: 460027-000; Group 4: 460027-003
<b>Description</b>	Configure how long it takes for the circular chart to be written to once completely (one complete revolution). Note: The device only ever shows 1/4 of the circular chart.
<b>Selection</b>	1 hour , x hours , 1 day, x days
<b>Factory setting</b>	1 hour

---

### "E-mail" submenu

---

**Navigation**

 Expert → Application → E-mail  
 In the case of the "Telealarm" option under  
 Expert → Application → Telealarm → General → Setup e-mail

**Description**

Contains settings required if alarms are to be transmitted by e-mail.  
 Test the e-mail settings under Diagnostics → Simulation → E-mail.

---

**SMTP host**

---

**Navigation**

 Expert → Application → E-mail → SMTP host  
 Direct access code: 510062-000

**Description**

Enter your SMTP host here. If necessary, contact your network administrator or e-mail provider.

**User entry**

Text (max. 40 characters)

---

**Server requires SSL**

---

**Navigation**

 Expert → Application → E-mail → Server requires SSL  
 Direct access code: 510061-000

**Description**

Specify whether the e-mail server requires a secure connection (SSL).  
 STARTTLS: Runs on the same TCP port as unencrypted SMTP (port 25 or 587).  
 SMTPS: Completely encrypted with own TCP port (465).  
 If necessary, contact your network administrator or e-mail provider.

**Selection**

No, Yes (SMTPS), Yes (STARTTLS)

**Factory setting**

No

---

**Port**

---

**Navigation**

 Expert → Application → E-mail → Port  
 Direct access code: 510063-000

**Description**

Enter your SMTP port here. If necessary, contact your network administrator or e-mail provider.

**User entry**

Number (max. 4 digits)

**Factory setting**



25



---

**Sender**

---

<b>Navigation</b>	 Expert → Application → E-mail → Sender Direct access code: 510064-000
<b>Description</b>	Enter the e-mail address of the device here (this text appears as the sender of the e-mail). If necessary, contact your network administrator or e-mail provider.  If a valid e-mail address is not configured this might cause e-mail transmission problems, depending on the particular provider.
<b>User entry</b>	Text (max. 60 characters)

---

**User name**

---

<b>Navigation</b>	 Expert → Application → E-mail → User name Direct access code: 510066-000
<b>Description</b>	Configure the user name of the e-mail account here. If necessary, contact your network administrator or e-mail provider.
<b>User entry</b>	Text (max. 60 characters)

---

**Password**



---

<b>Navigation</b>	 Expert → Application → E-mail → Password Direct access code: 510067-000
<b>Description</b>	Enter the password for authentication here. If necessary, contact your network administrator or e-mail provider.
<b>User entry</b>	Text (max. 22 characters)

---

**"E-mail addresses" submenu**



---

<b>Navigation</b>	 Expert → Application → E-mail → E-mail addresses
<b>Description</b>	Here, enter all the e-mail addresses messages should be sent to in the event of an alarm.  Assignment to the alarms is performed later on.

---

**E-mail address x**



---

<b>Navigation</b>	 Expert → Application → E-mail → E-mail addresses → E-mail address x Direct access code: E-mail address 1: 510080-000 ... E-mail address 5: 510084-000
<b>Description</b>	Here, enter an e-mail address a message should be sent to.  Assignment to the alarms is performed later on.
<b>User entry</b>	Text (max. 60 characters)

---

### "Limit value violations" submenu

---

<b>Navigation</b>	 Expert → Application → E-mail → Limit value violations
<b>Description</b>	Specify who should receive e-mails when limit value violations occur (both on and off messages).  Only for limit values where "Save message" is set to "Yes".

---

### Recipient x



---

<b>Navigation</b>	 Expert → Application → E-mail → Limit value violations → Recipient x Direct access code: Recipient 1: 510110-000; Recipient 2: 510111-000
<b>Description</b>	Select who should receive the e-mail.
<b>Selection</b>	Not used, E-mail address x
<b>Factory setting</b>	Not used

---

### "On/off messages" submenu

---

<b>Navigation</b>	 Expert → Application → E-mail → On/off messages
<b>Description</b>	Specify who should receive e-mails when "on"/"off" messages occur (for digital inputs or maths channels).  Only for inputs where "Save event" is set to "Yes".

---

### Recipient x

---

<b>Navigation</b>	 Expert → Application → E-mail → On/off messages → Recipient x Direct access code: Recipient 1: 510115-000; Recipient 2: 510116-000
-------------------	--

---

**Description** Select who should receive the e-mail.

**Selection** Not used, E-mail address x

**Factory setting** Not used

---

#### "Errors (Fxxx/Sxxx)" submenu

---

**Navigation**  Expert → Application → E-mail → Errors (Fxxx/Sxxx)

**Description** Specify who should receive e-mails when errors occur (Fxxx and Sxxx messages).

---

#### Recipient x

---

**Navigation**  Expert → Application → E-mail → Errors → Recipient x  
Direct access code:  
Recipient 1: 510120-000; Recipient 2: 510121-000

**Description** Select who should receive the e-mail.

**Selection** Not used, E-mail address x

**Factory setting** Not used

---

#### "Maintenance required" (submenu)

---

**Navigation**  Expert → Application → E-mail → Maintenance required

**Description** Specify who should receive e-mails when maintenance is required (Mxxx messages).

---

#### Recipient x

---

**Navigation**  Expert → Application → E-mail → Maintenance required → Recipient x  
Direct access code:  
Recipient 1: 510130-000; Recipient 2: 510131-000

**Description** Select who should receive the e-mail.

**Selection** Not used, E-mail address x

**Factory setting** Not used

---

#### "Printer" submenu

---

**Navigation**
 Expert → Application → Printer
**Description**

Contains printer settings.

 Only relevant if a printer is directly connected to the device.

Parameter	Description	Direct access code
Printer	Please select the printer you wish to use. For supported printers please refer to the Operating Instructions.	540000-000
IP address	Enter the IP address of the network printer here. If you do not know the IP address, contact your network administrator. Note: A DNS name may also be used.	540001-000
Port	Please enter the port of your network printer (available from your network administrator). Note: Port 9100 is usually used.	540002-000
Color printer	Please specify whether you are using a black and white or color printer.	540003-000
Paper size	Please select the paper size of your printer.	540004-000
Print direction	Select the print direction as per the properties of the printer used.	540006-000
Characters/line	Enter the maximum number of characters per line here.	540007-000
Blank rows at the end	Enter the number of blank lines required at the end of the printout to make it easier to tear off.	540008-000
Fault switches	You can switch a relay if an error occurs during the printout. The relay remains switched until the printer is ready again or the device is restarted.	540005-000
"Serial interface" submenu	Settings required if you are using the RS232 or RS485 interface of the device.	150101-000 150103-000

**"Softkeys" submenu**
 This function is **not** supported by the **DIN rail version**.
**Navigation**
 Expert → Application → Softkeys
**Description**

You can configure the functions that are assigned to the softkeys of the device.

**Softkey 1-3****Navigation**
 Expert → Application → Softkeys → Softkey x  
 Direct access code, softkey 1: 520000-000  
 Direct access code, softkey 2: 520001-000  
 Direct access code, softkey 3: 520002-000
**Description**

Specify the function to be assigned to this softkey.

**Selection**

Not used, Safe SD card removal, Remove USB stick safely, Printout, Enter batch info, Event log / audit trail, Historic measured values, Log onto device, Log out from device, Screenshot, Search in trace, Show analyses, Change set point, Next group, Operation

<b>Factory setting</b>	Softkey 1: Event log/audit trail Softkey 2: Historic measured values Softkey 3: Search in trace
------------------------	---

---

### "Texts" submenu

---

<b>Navigation</b>	 Expert → Application → Texts
<b>Description</b>	Settings only needed if you want to save text for subsequent reporting. Here, configure the text that can be saved in the event log during operation.

---

### Text 1-30



---

<b>Navigation</b>	 Expert → Application → Texts → Text x Direct access code, text 1: 530000-000 ... Direct access code, text 30: 530029-000
<b>Description</b>	Generate or change the text.
<b>User entry</b>	Text (max. 22 characters)

---

### "Wastewater" submenu (option)



---

<b>Navigation</b>	 Expert → Application → Wastewater
<b>Description</b>	Contains settings for using the device in the wastewater sector.  Detailed descriptions of this device option can be found in the associated documentation.

---

### "Telealarm" submenu (option)

---

<b>Navigation</b>	 Expert → Application → Telealarm
<b>Description</b>	Contains settings for alerts via a modem connected to the device or by e-mail.  Detailed descriptions of this device option can be found in the associated documentation.

---



### "WebDAV Client" submenu

---

<b>Navigation</b>	 Expert → Application → WebDAV Client
-------------------	--

**Description**

All recorded data are transmitted to an external WebDAV server (e.g. NAS). The format can be specified or selected via **"Setup → Advanced setup → System → External memory → Save as"**.

Parameter	Description	Direct access code
Enable	Switch the WebDAV client functionality on/off. When active, the device copies the saved measured values automatically to the configured server.  Only possible using the Ethernet interface! <b>Options:</b> No, Yes, Yes (SSL) <b>Factory setting:</b> No	472000-000
IP address	Enter the IP address of the WebDAV server here.  A DNS name can also be used. <b>User entry:</b> IP address <b>Factory setting:</b> 0.0.0.0	472001-000
Port	This communication port is used to communicate with the WebDAV Server.  If your network is protected by a firewall, this port may have to be enabled. Please contact your network administrator if this is the case. <b>User entry:</b> Numbers (max. 5 digits) <b>Factory setting:</b> 80	472002-000
User name	Input of the user name that can access the WebDAV server. <b>User entry:</b> Text (max. 20 characters)	472004-000
Password	Password for accessing the WebDAV server. <b>User entry:</b> Text (max. 20 characters)	472007-000
Directory	Enter the directory in which the data should be saved. <b>User entry:</b> Text (max. 120 characters)	472005-000
Save as	"Protected format": All data is stored in a manipulation protected encrypted format. This data can only be visualized by the PC analysis software supplied. "Open format": Data is stored in a CSV format, this can be opened by a number of different programs (for e.g. MS Excel) (Attention: no manipulation security). <b>Options:</b> Protected format, Open format (*.csv) <b>Factory setting:</b> Protected format	472010-000

 Test the WebDAV client settings under **"Diagnostics → Simulation → WebDAV client"**.

**17.1.6 "Diagnostics" submenu**

Device information and service functions for a quick device check.

 Only some of the diagnostic functions are available under Expert → Diagnostics! For other functions, see the Main menu → Diagnostics

---

**Actual diagnostics**  
(Online configuration)
**Navigation**

 Expert → Diagnostics → Actual diagnostics  
Direct access code: 050000-000

**Description**

Displays the current diagnosis message.

---

**Last diagnostics**  
 (Online configuration)
 

---

**Navigation**  Expert → Diagnostics → Last diagnostics  
 Direct access code: 050005-000

**Description** Displays the last diagnosis message.

---

**Last restart**  
 (Online configuration)
 

---

**Navigation**  Expert → Diagnostics → Last restart  
 Direct access code: 050010-000

**Description** Information as to when the device was last restarted (e.g. due to a power failure).

---

**"Event log" submenu**

---

**Navigation**  Expert → Diagnostics → Event log

**Description** Events such as alarm set point infringement and power failure are listed in the correct time sequence.

---

**"Device information" submenu**  
 (Online configuration)
 

---

**Navigation**  Expert → Diagnostics → Device information

**Description** Displays important device information.

---

**Device tag**

---

**Navigation**  Expert → Diagnostics → Device information → Device tag  
 Direct access code: 000031-000

**Description** Individual device tag name/unit identifier (max. 32 characters).

---

**Serial number**  
 (Online configuration)
 

---

**Navigation**

 Expert → Diagnostics → Device information → Serial number  
Direct access code: 000027-000

**Description**

Individual serial number of the device. Please provide these details when ordering spare parts or asking any questions about the unit.

**Order code**

(Online configuration)

**Navigation**

 Expert → Diagnostics → Device information → Order code  
Direct access code: 000029-000

**Description**

Displays the order code.  
The order code indicates the attribute of all the features of the product structure for the device and thus uniquely identifies the device. It can also be found on the nameplate.

**Uses of the order code**

- To order an identical replacement device.
- To check the ordered device features using the delivery note.

**Firmware version**

(Online configuration)

**Navigation**

 Expert → Diagnostics → Device information → Firmware version  
Direct access code: 000026-000

**Description**

Displays the installed firmware version of the device. Please send these details with any questions about the unit.

**ENP version**

(Online configuration)

**Navigation**

 Expert → Diagnostics → Device information → ENP version  
Direct access code: 000032-000

**Description**

Displays the version of the electronic nameplate. Please send these details with any questions about the unit.

**ENP device name**

(Online configuration)

**Navigation**

 Expert → Diagnostics → Device information → ENP device name  
Direct access code: 000020-000



---

**Description** Displays the ENP device name (electronic name plate). Please send these details with any questions about the unit.

---

**Device name**  
(Online configuration)

---

**Navigation**  Expert → Diagnostics → Device information → Device name  
Direct access code: 000021-000

**Description** Displays the device name. Please send these details with any questions about the unit.

---

**Manufacturer ID**  
(Online configuration)

---

**Navigation**  Expert → Diagnostics → Device information → Manufacturer ID  
Direct access code: 000022-000

**Description** Displays the manufacturer ID. Please send these details with any questions about the unit.

---

**Manufacturer name**  
(Online configuration)

---

**Navigation**  Expert → Diagnostics → Device information → Manufacturer name  
Direct access code: 000023-000

**Description** Displays the manufacturer name. Please send these details with any questions about the unit.

---

**Firmware**  
(Online configuration)

---

**Navigation**  Expert → Diagnostics → Device information → Firmware  
Direct access code: 009998-000

**Description** Displays the installed firmware of the device. Please send these details with any questions about the unit.

---

**"Simulation" submenu**

---

**Navigation**  Expert → Diagnostics → Simulation

---

**Description** Settings for simulation mode.

---

**Operating mode**

---

**Navigation**  Expert → Diagnostics → Simulation → Operating mode  
Direct access code: 010010-000

**Description** Normal operation: Unit plots the signals from the connected measurement points.  
Simulation: Instead of operating with the real measurement points the signals are simulated (using the actual settings).

**Selection** Normal operation, Simulation

**Factory setting** Normal operation

# Index

## Symbols

--> Profibus DP (parameter) . . . . . 212

## 0 ... 9

1 hour= (parameter) . . . . . 177  
 1 revolution = (parameter) . . . . . 263  
 1 second= (parameter) . . . . . 177

## A

Access code (parameter) . . . . . 141  
 Acknowledging messages (parameter) . . . . . 146  
 Action (parameter) . . . . . 178  
 Activation code (parameter) . . . . . 149  
 Actual diagnostics (parameter) . . . . . 270  
 Actual value (parameter) . . . . . 168, 169, 186  
 Add HART value (parameter) . . . . . 202  
 Add input (parameter) . . . . . 152, 174  
 Add limit value (parameter) . . . . . 245  
 Admin ID (parameter) . . . . . 197  
 Admin password (parameter) . . . . . 198  
 Administrator (parameter) . . . . . 197  
 Administrator, ID, password (parameter) . . . . . 142  
 Alarm cycle (parameter) . . . . . 255  
 Alarm response (parameter) . . . . . 147  
 Alarm statistics (parameter) . . . . . 243  
 Analysis x (parameter) . . . . . 242  
 Analysis x for automatic printout (parameter) . . . . . 244  
 Application (parameter) . . . . . 152, 214  
 Application (submenu) . . . . . 213  
 Authentication (submenu) . . . . . 142  
 Automatic printout (submenu) . . . . . 244

## B

Barcode reader (submenu) . . . . . 148  
 Bargraph (parameter) . . . . . 262  
 Batch (parameter) . . . . . 195  
 Batch assignment (parameter) . . . . . 262  
 Batch mode (parameter) . . . . . 254  
 Baud rate (parameter) . . . . . 204  
 Begin summer time (parameter) . . . . . 136

## C

Cable open circuit (parameter) . . . . . 172  
 Calc. factor (parameter) . . . . . 159, 171, 237  
 CE mark . . . . . 128  
 CE mark (declaration of conformity) . . . . . 9  
 Change date/time (submenu) . . . . . 135  
 Change limits (parameter) . . . . . 245  
 Channel ident. (parameter) . . . . . 157, 176  
 Channel/value (parameter) . . . . . 246  
 Character set (parameter) . . . . . 148  
 Check table (parameter) . . . . . 166  
 Check table for linearization (parameter) . . . . . 239  
 Circular chart (submenu) . . . . . 263  
 Clear memory (parameter) . . . . . 133  
 Communication  
   Ethernet TCP/IP . . . . . 27

Communication (parameter) . . . . . 151  
 Communication (submenu) . . . . . 189  
 Comparison point (parameter) . . . . . 163  
 Comparison temp. (parameter) . . . . . 163  
 Configuration softwareFieldCare . . . . . 52  
 Configuration Web server (submenu) . . . . . 194  
 Connection (parameter) . . . . . 155  
 Connection quality (parameter) . . . . . 199  
 Control relays (parameter) . . . . . 196  
 Copy settings (parameter) . . . . . 174, 182, 241, 254  
 Correction RPT (parameter) . . . . . 167  
 CSV settings (parameter) . . . . . 145  
 Current date/time (parameter) . . . . . 135  
 Curve display (parameter) . . . . . 261

## D

d at 20 °C (parameter) . . . . . 231  
 D at 20 °C (parameter) . . . . . 231  
 Damping (parameter) . . . . . 163  
 Damping/filter (parameter) . . . . . 184  
 Data type (parameter) . . . . . 157  
 Date (parameter) . . . . . 137, 139  
 Date format (parameter) . . . . . 134  
 Date/time (parameter) . . . . . 135, 145  
 Date/time (submenu) . . . . . 134  
 Date/time setup (submenu) . . . . . 134  
 Day (parameter) . . . . . 137, 138  
 Decimal point (parameter) . . . . . 160, 176  
 Decimal separator (parameter) . . . . . 131  
 Declaration of Conformity . . . . . 9  
 Delete HART value (parameter) . . . . . 202  
 Delete input (parameter) . . . . . 153, 175  
 Delete limit value (parameter) . . . . . 245  
 Density (parameter) . . . . . 232  
 Density unit (parameter) . . . . . 233  
 Description 'H' (parameter) . . . . . 180, 221  
 Description 'L' (parameter) . . . . . 180, 222  
 Design density (parameter) . . . . . 233  
 Device address (parameter) . . . . . 205, 206  
 Device info (submenu) . . . . . 271  
 Device name . . . . . 273  
 Device options (submenu) . . . . . 149  
 Device tag . . . . . 271  
 Device tag (parameter) . . . . . 130  
 Device type (parameter) . . . . . 214  
 DHCP (parameter) . . . . . 190  
 Diagnostic messages . . . . . 83  
 Diagnostics (submenu) . . . . . 270  
 Diameter unit (parameter) . . . . . 231  
 Differential pressure (parameter) . . . . . 230  
 Digital inputs (submenu) . . . . . 174  
 Dim. linearized value (parameter) . . . . . 165, 238  
 Direct access (parameter) . . . . . 130  
 Disable port (parameter) . . . . . 192  
 Display (parameter) . . . . . 256, 257, 258, 259, 260  
 Display black (parameter) . . . . . 256

Display blue (parameter) . . . . . 256  
 Display brown (parameter) . . . . . 260  
 Display cyan (parameter) . . . . . 259  
 Display green (parameter) . . . . . 257  
 Display orange (parameter) . . . . . 259  
 Display red (parameter) . . . . . 257  
 Display violet (parameter) . . . . . 258  
 Domain Name System (DNS) (parameter) . . . . . 192  
 DP flow (submenu) . . . . . 230  
 DP unit (parameter) . . . . . 231  
 Draw help line (parameter) . . . . . 254

**E**

E-mail (submenu) . . . . . 263  
 E-mail address x (parameter) . . . . . 265  
 E-mail addresses (submenu) . . . . . 265  
 End summer time (parameter) . . . . . 138  
 End value range (parameter) . . . . . 160  
 Engineering unit (parameter) . . . . . 158, 176  
 ENP device name . . . . . 272  
 ENP version . . . . . 272  
 Error (Fxxx/Sxxx) (submenu) . . . . . 267  
 Error messages . . . . . 83  
 Error value (parameter) . . . . . 173, 187, 241  
 Ethernet . . . . . 43  
 Ethernet configuration (submenu) . . . . . 190  
 Event log (submenu) . . . . . 271  
 Event message (parameter) . . . . . 181, 222  
 Event text H->L (parameter) . . . . . 181, 223  
 Event text L->H (parameter) . . . . . 181, 223  
 Event text LV off (parameter) . . . . . 252  
 Event text LV on (parameter) . . . . . 252  
 Expert (Menu) . . . . . 130  
 External memory (submenu) . . . . . 143

**F**

Fault mode (parameter) . . . . . 202  
 Fault mode (submenu) . . . . . 171, 187, 240  
 Fault switching (parameter) . . . . . 131  
 FDA 21 CFR Part 11 . . . . . 128  
 Field Data Manager (FDM) analysis software  
   Function scope . . . . . 41  
 Fieldbus (parameter) . . . . . 151  
 FieldCare/DeviceCare configuration software  
   Function scope . . . . . 42  
 Firmware (parameter) . . . . . 273  
 Firmware update (parameter) . . . . . 194  
 Firmware version (parameter) . . . . . 272  
 Flow (parameter) . . . . . 215  
 Flow engineering unit (parameter) . . . . . 215  
 Flow installation point (parameter) . . . . . 215  
 Formula (parameter) . . . . . 214  
 Formula editor (parameter) . . . . . 225  
 Formula editor (submenu) . . . . . 224  
 Front of housing (parameter) . . . . . 152  
 Full scale value (parameter) . . . . . 184  
 Function (parameter) . . . . . 175  
 Function USB-B (parameter) . . . . . 190

**G**

Gateway (parameter) . . . . . 191  
 Get timeout (parameter) . . . . . 199  
 Grid divisions (parameter) . . . . . 260  
 Group (parameter) . . . . . 179  
 Group days (parameter) . . . . . 243  
 Group x (submenu) . . . . . 255

**H**

HART (submenu) . . . . . 201  
 HART attempts on error (parameter) . . . . . 201  
 HART channel ident. (parameter) . . . . . 204  
 HART connection (parameter) . . . . . 203  
 HART device address (parameter) . . . . . 203  
 HART IP port (parameter) . . . . . 193  
 HART master type (parameter) . . . . . 201  
 HART process variable (parameter) . . . . . 203  
 Hysteresis (abs.) (parameter) . . . . . 250

**I**

Identifier (parameter) . . . . . 188, 249, 255  
 Input factor in (parameter) . . . . . 177  
 Inputs (submenu) . . . . . 152  
 IP address (parameter) . . . . . 155, 191  
 Isentropic exponent (parameter) . . . . . 233

**K**

K-factor (parameter) . . . . . 232  
 Keyboard layout (parameter) . . . . . 131

**L**

Language (parameter) . . . . . 130  
 Last diagnostics (parameter) . . . . . 271  
 Last restart (parameter) . . . . . 271  
 LED mode (parameter) . . . . . 133  
 Limit value violations (submenu) . . . . . 266  
 Limit x (submenu) . . . . . 246  
 Limits (submenu) . . . . . 245  
 Linearization (parameter) . . . . . 164, 238  
 Linearization (submenu) . . . . . 164, 237  
 Linearization points (submenu) . . . . . 239  
 Lock hardware (parameter) . . . . . 142  
 Lock operation (parameter) . . . . . 132  
 Low flow cut off (parameter) . . . . . 170, 236  
 Lower correction value (parameter) . . . . . 185  
 Lower error value (parameter) . . . . . 172  
 Lower frequency (parameter) . . . . . 160  
 LV messages (parameter) . . . . . 251

**M**

MAC address (parameter) . . . . . 190  
 Maintenance required (submenu) . . . . . 267  
 Manufacturer ID (parameter) . . . . . 273  
 Manufacturer name . . . . . 273  
 Maths (submenu) . . . . . 213  
 Maths x action (parameter) . . . . . 220  
 Maths x channel ident. (parameter) . . . . . 214  
 Maths x decimal point (parameter) . . . . . 219  
 Maths x engineering unit (parameter) . . . . . 219

- Maths x function (parameter) . . . . . 213  
 Maths x plot type (parameter) . . . . . 219  
 Maths x set point (parameter) . . . . . 221  
 Max. decade (parameter) . . . . . 261  
 Meas. range end (parameter) . . . . . 161, 169  
 Meas. val. without login (parameter) . . . . . 196  
 Meas.val. corrct. (submenu) . . . . . 167, 185  
 Measured value type (parameter) . . . . . 154  
 Medium (parameter) . . . . . 217  
 Memory build-up (parameter) . . . . . 144  
 Messages (submenu) . . . . . 145  
 Min. decade (parameter) . . . . . 260  
 Modbus (parameter) . . . . . 206  
 Modbus Master (parameter) . . . . . 151, 208  
 Modbus Master (submenu) . . . . . 208  
 Modbus Master baud rate (parameter) . . . . . 210  
 Modbus Master command distribution (parameter) . . . . . 209  
 Modbus Master connection attempts (parameter) . . . . . 209  
 Modbus Master parity (parameter) . . . . . 210  
 Modbus Master pause between commands  
 (parameter) . . . . . 209  
 Modbus Master Register per command (parameter) . . . . . 209  
 Modbus Master response timeout (parameter) . . . . . 208  
 Modbus Master scan cycle (parameter) . . . . . 208  
 Modbus Master serial interface (submenu) . . . . . 210  
 Modbus Master stop bits (parameter) . . . . . 210  
 Modbus RTU/(TCP/IP) . . . . . 45  
 Modbus Slave (submenu) . . . . . 206  
 Modbus Slave baud rate (parameter) . . . . . 207  
 Modbus Slave parity (parameter) . . . . . 207  
 Modbus Slave serial interface (submenu) . . . . . 207  
 Modbus Slave stop bits (parameter) . . . . . 207  
 Month (parameter) . . . . . 137, 139
- N**
- NAMUR NE 43 (parameter) . . . . . 171, 187  
 NT/ST changeover (parameter) . . . . . 136  
 NT/ST changeover (submenu) . . . . . 136  
 NT/ST region (parameter) . . . . . 136  
 Number of linearization points (parameter) . . . . . 238  
 Number of points (parameter) . . . . . 164
- O**
- Occurrence (parameter) . . . . . 136, 138  
 OFF daily from (parameter) . . . . . 147  
 Offset (parameter) . . . . . 167  
 ON daily from (parameter) . . . . . 147  
 On error (parameter) . . . . . 173, 187, 241  
 On/off messages (submenu) . . . . . 266  
 OPC port (parameter) . . . . . 193  
 OPC server  
   Function scope . . . . . 41  
 Operating mode (parameter) . . . . . 188, 274  
 Operation options  
   Local operation . . . . . 32  
   Operating tool . . . . . 32  
   Overview . . . . . 32  
 Operational safety . . . . . 9  
 Operational time (parameter) . . . . . 145
- Operator (parameter) . . . . . 197  
 Operator ID (parameter) . . . . . 197  
 Operator password (parameter) . . . . . 197  
 Operator, ID, password (parameter) . . . . . 142  
 Order code . . . . . 272  
 Other standards and guidelines . . . . . 128  
 Output (submenu) . . . . . 183  
 Overview of symbols . . . . . 38
- P**
- Paper size (parameter) . . . . . 132  
 Parity (parameter) . . . . . 205  
 Password (parameter) . . . . . 265  
 Ping interval (parameter) . . . . . 200  
 Ping retry (parameter) . . . . . 200  
 Ping timeout (parameter) . . . . . 200  
 Pipe material (parameter) . . . . . 232  
 Plot type (parameter) . . . . . 157  
 Point 1 viscosity (parameter) . . . . . 234  
 Point 2 viscosity (parameter) . . . . . 234  
 Points (submenu) . . . . . 166  
 Poll timeout (parameter) . . . . . 201  
 Port (parameter) . . . . . 156, 192, 194, 206, 264  
 PRESET (parameter) . . . . . 133  
 Pressure (parameter) . . . . . 216  
 Pressure engineering unit (parameter) . . . . . 216  
 Printer (submenu) . . . . . 267  
 Product safety . . . . . 9  
 Profibus DP (submenu) . . . . . 211  
 Profibus DP bit 0.0 to 0.7 (parameter) . . . . . 213  
 Profibus DP byte x..y (parameter) . . . . . 212  
 Profibus DP Master in/out (parameter) . . . . . 211  
 Profibus DP Slave address (parameter) . . . . . 211  
 Profibus DP slot x (submenu) . . . . . 211  
 Protected by (parameter) . . . . . 141  
 Protocol (parameter) . . . . . 204  
 Pulse counter (parameter) . . . . . 159  
 Pulse value (parameter) . . . . . 159, 177, 184  
 Pulse width (parameter) . . . . . 185  
 Put timeout (parameter) . . . . . 200
- R**
- Range (parameter) . . . . . 153  
 Range start (parameter) . . . . . 161, 168  
 Readout function (parameter) . . . . . 156  
 Recipient x (parameter) . . . . . 266, 267  
 Record duration (parameter) . . . . . 182, 223  
 Record duration of LV on (parameter) . . . . . 253  
 Reference channel (parameter) . . . . . 183  
 Register address (parameter) . . . . . 157  
 Registered trademarks . . . . . 8  
 Relay (submenu) . . . . . 188  
 Remote control (parameter) . . . . . 195  
 Remote controlled (parameter) . . . . . 188  
 Reset channel (parameter) . . . . . 244  
 Reset relay (parameter) . . . . . 253  
 Reset to zero (parameter) . . . . . 243  
 Return . . . . . 95

**S**

Save as (parameter) . . . . .	143
Save as event (parameter) . . . . .	148
Save cycle (parameter) . . . . .	253, 255
Save event (parameter) . . . . .	174, 180, 222, 252
Save group (parameter) . . . . .	263
Screensaver (parameter) . . . . .	146
Screensaver (submenu) . . . . .	146
SD card (parameter) . . . . .	143
Security (submenu) . . . . .	140
Sender (parameter) . . . . .	265
Separator for CSV (parameter) . . . . .	145
Serial interface (submenu) . . . . .	204
Serial number . . . . .	271
Server requires SSL (parameter) . . . . .	264
Service (parameter) . . . . .	198
Service ID (parameter) . . . . .	198
Service password (parameter) . . . . .	198
Service, ID, password (parameter) . . . . .	143
Set point (parameter) . . . . .	179, 250
Set point 2 (parameter) . . . . .	250
Set point code (parameter) . . . . .	141
Set timeout (parameter) . . . . .	199
Setup (parameter) . . . . .	194
Setup via Web server . . . . .	49
Show Profibus DP status (parameter) . . . . .	211
Signal (parameter) . . . . .	153, 183
Signal analysis (submenu) . . . . .	242
Signal groups (submenu) . . . . .	254
Simulation (submenu) . . . . .	273
Slave address (parameter) . . . . .	156
Slot 1 (parameter) . . . . .	149
Slot 2 (parameter) . . . . .	150
Slot 3 (parameter) . . . . .	150
Slot 4 (parameter) . . . . .	150
Slot 5 (parameter) . . . . .	151
SMTTP host (parameter) . . . . .	264
SNTP (parameter) . . . . .	140
SNTP (submenu) . . . . .	139
SNTP server 1 (parameter) . . . . .	140
SNTP server 2 (parameter) . . . . .	140
Softkey 1-3 (parameter) . . . . .	268
Softkeys (submenu) . . . . .	268
Sort table (parameter) . . . . .	166
Sort table for linearization (parameter) . . . . .	239
Staff	
Requirements . . . . .	8
Start value (parameter) . . . . .	183
Start value range (parameter) . . . . .	160
Stop bits (parameter) . . . . .	205
Structure of the operating menu . . . . .	33, 34
Subnetmask (parameter) . . . . .	191
Swap mouse buttons (parameter) . . . . .	132
Switches (parameter) . . . . .	189, 251
Switches relay (parameter) . . . . .	144, 146, 179, 221
Symbols	
Event logbook . . . . .	40
Operating menus . . . . .	39
Synchron. time (parameter) . . . . .	242

System (submenu) . . . . .	130
----------------------------	-----

**T**

Target value (parameter) . . . . .	168, 169, 185, 186
Telealarm (submenu) . . . . .	269
Temp. unit (parameter) . . . . .	131
Temperature (parameter) . . . . .	234
Temperature (steam/cold) (heat difference) (parameter) . . . . .	217
Temperature (water/steam/warm) (parameter) . . . . .	216
Temperature engineering unit, water/steam (parameter) . . . . .	217
Text 1-30 (parameter) . . . . .	269
Text entry . . . . .	40
Texts (submenu) . . . . .	269
The result is (parameter) . . . . .	218
Time (parameter) . . . . .	138, 139
Time base (parameter) . . . . .	158
Time delay (parameter) . . . . .	173, 177, 251
Time format (parameter) . . . . .	134
Time span dt (parameter) . . . . .	250
Timeout (parameter) . . . . .	189
Timeout fieldbus (parameter) . . . . .	189
Timeout sequences (parameter) . . . . .	149
Timeouts (submenu) . . . . .	198
Total. eng. unit (parameter) . . . . .	236
Totalization (parameter) . . . . .	169, 235
Totalization (submenu) . . . . .	169, 235
Totalization base (parameter) . . . . .	170, 235
Totalizer (parameter) . . . . .	164, 171, 182, 224, 237
Transmission protocol (parameter) . . . . .	155
Troubleshooting	
Alarm relay . . . . .	82
Type (parameter) . . . . .	246
Type RS232/RS485 (parameter) . . . . .	204

**U**

Unit (parameter) . . . . .	170, 236
Unit/dimension counter (parameter) . . . . .	158
Universal input x (submenu) . . . . .	153
Universal inputs (submenu) . . . . .	152
Universal output (submenu) . . . . .	183
Upper correction value (parameter) . . . . .	186
Upper error value (parameter) . . . . .	172
Upper frequency (parameter) . . . . .	161
User name (parameter) . . . . .	265
UTC time zone (parameter) . . . . .	135

**V**

Value (parameter) . . . . .	154
Value x HART (submenu) . . . . .	203
Viscosity (parameter) . . . . .	234, 235
Viscosity (submenu) . . . . .	234

**W**

Warning at (parameter) . . . . .	144
Wastewater (submenu) . . . . .	269
Water/glycol concentration (parameter) . . . . .	218
Web server . . . . .	64
Function scope . . . . .	41

Web server (parameter) . . . . .	193
Web server authentication (submenu) . . . . .	196
WebDAV Client (submenu) . . . . .	269
WebDAV server (parameter) . . . . .	195
Week starting on (parameter) . . . . .	243
Wet steam alarm (parameter) . . . . .	241
Workplace safety . . . . .	9

**X**

x-value (1 to 32) (parameter) . . . . .	166
x-value (1 to 32) for linearization (parameter) . . . . .	240

**Y**

y-value (1 to 32) (parameter) . . . . .	167
y-value (1 to 32) for linearization (parameter) . . . . .	240

**Z**

Zoom (parameter) . . . . .	262
Zoom end (parameter) . . . . .	162, 165, 224
Zoom end for linearization (parameter) . . . . .	239
Zoom start (parameter) . . . . .	162, 165, 223
Zoom start for linearization (parameter) . . . . .	238



[www.addresses.endress.com](http://www.addresses.endress.com)

---