

GasAlert MaxXT

1, 2, 3, and 4-Gas Detector

Operator's Manual

BW
Technologies
by Honeywell

Limited Warranty and Limitation Liability

BW Technologies LP (BW) warrants the product to be free from defects in material and workmanship under normal use and service for a period of two years, beginning on the date of shipment to the buyer. This warranty extends only to the sale of new and unused products to the original buyer. BW's warranty obligation is limited, at BW's option, to refund of the purchase price, repair or replacement of a defective product that is returned to a BW authorized service center within the warranty period. In no event shall BW's liability hereunder exceed the purchase price actually paid by the buyer for the Product.

This warranty does not include:

- a) fuses, disposable batteries or the routine replacement of parts due to the normal wear and tear of the product arising from use;
- b) any product which in BW's opinion, has been misused, altered, neglected or damaged, by accident or abnormal conditions of operation, handling or use;
- c) any damage or defects attributable to repair of the product by any person other than an authorized dealer, or the installation of unapproved parts on the product; or

The obligations set forth in this warranty are conditional on:

- a) property storage, installation, calibration, use, maintenance and compliance with the product manual instructions and any other applicable recommendations of BW;
- b) the buyer promptly notifying BW of any defect and, if required, promptly making the product available for correction. No goods shall be returned to BW until receipt by the buyer of shipping instructions from BW; and
- c) the right of BW to require that the buyer provide proof of purchase such as the original invoice, bill of sale or packing slip to establish that the product is within the warranty period.

THE BUYER AGREES THAT THIS WARRANTY IS THE BUYER'S SOLE AND EXCLUSIVE REMEDY AND IS IN LIEU OF ALL OTHER WARRANTIES, EXPRESS OR IMPLIED, INCLUDING BUT NOT LIMITED TO ANY IMPLIED WARRANTY OF MERCHANTABILITY OR FITNESS FOR A PARTICULAR PURPOSE. BW SHALL NOT BE LIABLE FOR ANY SPECIAL, INDIRECT, INCIDENTAL, OR BASED ON CONTRACT, TORT OR RELIANCE OR ANY OTHER THEORY.

Since some countries or states do not allow limitation of the term of an implied warranty, or exclusion or limitation of incidental or consequential damages, the limitations and exclusions of this warranty may not apply to every buyer. If any provision of this warranty is held invalid or unenforceable by a court of competent jurisdiction, such holding will not affect the validity or enforceability of any other provision.

Contacting BW Technologies by Honeywell

USA: 188-749-8878

Canada: 1-800-663-4164

Europe: +44(0) 1295 700300

Other countries: +1-403-248-9226

Email us at: info@gasmonitors.com

Visit BW Technologies by Honeywell website at: www.gasmonitors.com

GasAlertMax XT

Introduction

The operator's manual provides basic information to operate the GasAlertMax XT gas detector. For complete operating instructions, refer to the *GasAlertMax XT Technical Reference Guide* provided on the CD-ROM. The GasAlertMax XT gas detector ("the detector") is designed to warn of hazardous gas levels above user-defined alarm setpoints.

The detector is a personal safety device. It is your responsibility to respond properly to the alarm.

Note

The detector is shipped with English as the default displayed language. Additional languages provided are French, German, Spanish, and Portuguese. The screens for the additional languages are displayed on the detector and in the corresponding operator's manual.

Safety Information - Read First

Use the detector only as specified in this operator's manual and the technical reference guide, otherwise the protection provided by the detector may be impaired.

Read the following **Cautions** before using the detector.

Cautions

- **Warning:** Substitution of components may impair Intrinsic Safety.
- **Caution:** For safety reasons, this equipment must be operated and serviced by qualified personnel only. Read and understand the technical reference guide completely before operating or servicing.
- **Charge the detector before first-time use.** BW recommends the detector be charged after every workday.
- **Calibrate the detector before first-time use and then on a regular schedule, depending on use and sensor exposure to poisons and contaminants.** The sensors must be calibrated regularly and at least once every 180 days (6 months).

- Calibrate only in a safe area that is free of hazardous gas.
- The combustible sensor is factory calibrated to 50% LEL methane. If monitoring a different combustible gas in the % LEL range, calibrate the sensor using the appropriate gas.
- Only the combustible gas detection portion of this instrument has been assessed for performance by CSA International.
- Protect the combustible sensor from exposure to lead compounds, silicones, and chlorinated hydrocarbons. Although certain organic vapors (such as leaded gasoline and halogenated hydrocarbons) may temporarily inhibit sensor performance, in most cases, the sensor will recover after calibration.
- BW recommends that the combustible sensor be checked with a known concentration of calibration gas after any exposure to contaminants/poisons such as sulfur compounds, silicon vapors, halogenated compounds, etc.
- BW recommends to bump test the sensors before each day's use to confirm their ability to respond to gas by exposing the detector to a gas concentration that exceeds the alarm setpoints. Manually verify that the audible and visual alarms are activated. Calibrate if the readings are not within the specified limits.
- **Caution:** High off-scale LEL readings may indicate an explosive concentration.
- Any rapid up scaling reading followed by a declining or erratic reading may indicate a gas concentration beyond upper scale limit, which can be hazardous.

- For use only in potentially explosive atmospheres where oxygen concentrations do not exceed 20.9% (v/v).
- Extended exposure of the GasAlertMax XT to certain concentrations of combustible gases and air may stress the detector element that can seriously affect its performance. If an alarm occurs due to a high concentration of combustible gases, recalibration should be performed, or if needed, the sensor replaced.
- The BW pump (XT-RPUMP-K1) is certified for use with the GasAlertMax XT only.
- **Warning:** The lithium battery (MX-BAT01) may present a risk of fire or chemical burn hazard if misused. Do not disassemble, heat above 212°F (100°C), or incinerate.
- **Warning:** Do not use any other lithium batteries with the GasAlertMax XT detector. Use of any other cell can cause fire and/or explosion. To order and replace the MX-BAT01 lithium battery, contact BW Technologies by Honeywell.
- **Warning:** Lithium polymer cells exposed to heat at 266°F (130°C) for 10 minutes can cause fire and/or explosion.
- Dispose of used lithium cells immediately. Do not disassemble and do not dispose of in fire. Do not mix with the solid waste stream. Spent batteries must be disposed of by a qualified recycler or hazardous materials handler.
- Keep lithium cells away from children.
- All calibration cylinders must be used with a demand flow regulator and must meet the following maximum inlet pressure specifications:
 - Disposable cylinders 0-3000 psig/70 bar
 - Refillable cylinders 0-3000 psig/70 bar

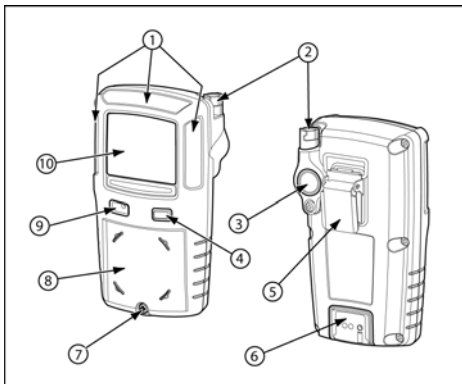
Parts of the GasAlertMax XT

Item	Description
1	Visual alarm indicators (LEDs)
2	Pump quick connector
3	Pump filter and moisture filter
4	Pushbutton
5	Alligator clip
6	Charging connector and IR interface
7	Diffusion cover locking screw (1)
8	Diffusion cover
9	Audible alarm
10	Liquid crystal display (LCD)

Display Elements

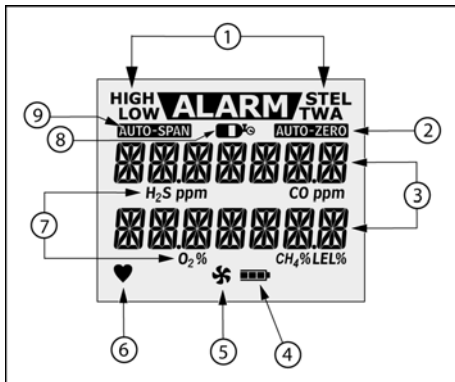

Item	Description
1	Alarm condition
2	Automatically zero sensor
3	Numeric values
4	Battery life indicator
5	Pump indicator
6	Heartbeat indicator
7	Gas type identifiers
8	Gas cylinder
9	Automatically span sensor

Pushbutton

Pushbutton	Description
	<ul style="list-style-type: none">• To activate the detector, press ○.• To deactivate the detector, press and hold ○ until the OFF countdown is complete.• To view the date/time, TWA, STEL, and maximum (MAX) readings, press ○ twice rapidly. To clear the TWA, STEL, and MAX readings, press ○ when the LCD displays CLEAR ALL.• To initiate calibration, press and hold ○ while the detector performs the OFF countdown. Continue holding ○ while the LCD briefly deactivates and then reactivates to begin the CAL countdown. Release ○ when the CAL countdown is complete.• To activate the backlight, press ○ and release.• To acknowledge latched and pump alarms, press ○.• To acknowledge a low alarm and disable the audible alarm, press ○. The Low Alarm Acknowledge option must be enabled in Fleet Manager II.• To acknowledge any of the Due Today alarms (calibration, bump test, block test) and disable the audible alarm, press ○.

Connecting the Gas Cylinder to the Detector

Gas Cylinder Guidelines

- To ensure accurate calibration, use a premium-grade calibration gas. Use gases approved by the National Institute of Standards and Technology.
- If a certified calibration is required, contact BW Technologies by Honeywell.
- Do not use a gas cylinder that is past its expiration date.

Gas Cylinder Connection

1. Verify the calibration gas being used matches the span concentration value(s) that are set for the detector.
2. Connect the calibration hose to the demand flow regulator on the gas cylinder.
3. Begin the calibration procedures.
4. When **AUTO-SPAN** displays, attach the hose quick connector to the pump quick connector.
5. When calibration is complete, disconnect the hose from the detector and the demand flow regulator.
6. Ensure the gas cylinder is stored according to manufacturer's specifications.

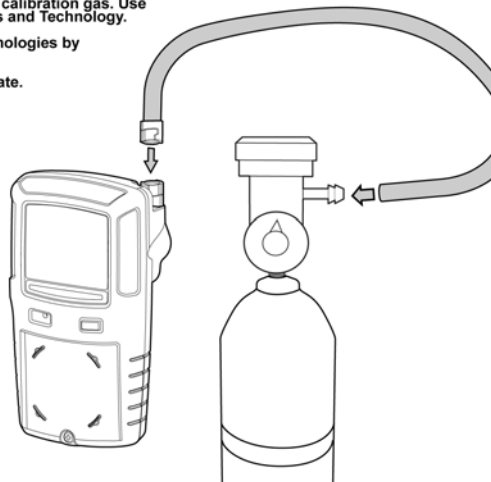



Calibration

⚠ Caution

Calibrate only in a safe area that is free of hazardous gas. Do not calibrate the detector during or immediately after charging is complete.

Note

The maximum hose length for calibration is 3 ft. (1 m).

1. Press and hold  as the detector performs the **OFF** countdown. Continue to hold  when the detector briefly deactivates.



2. The detector activates again and performs the **CAL** countdown. Continue to hold  until the countdown is complete to enter calibration.



3. **AUTO-ZERO** flashes while the detector zeroes all of the sensors.

If a sensor fails to auto zero, it cannot be spanned. When auto zero is complete, the LCD displays **APPLY GAS**.

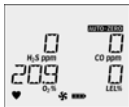

4. Refer to [Connecting the Gas Cylinder to the Detector](#) (page 7). Attach the demand flow regulator and apply gas.

Note

The diffusion cover must be attached to the detector to calibrate.

 flashes on the LCD. After a sufficient amount of gas has been detected (30 seconds), the detector beeps. **AUTO-SPAN** flashes while the detector completes the span.



The LCD displays **CAL DUE**. Next, a screen displays showing the number of days remaining before calibration is due for each sensor. Last, the LCD displays (e.g.) **CAL DUE 180 d**. As some sensors require more frequent calibrations, the LCD displays the earliest calibration that must be performed.











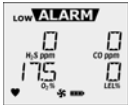
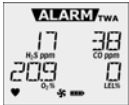
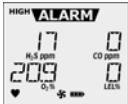

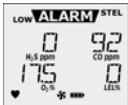

Note

Calibration can be aborted at any time. To abort calibration, press . The **CAL ABORTED** screen displays.

Alarms

Refer to the following table for information about alarms and corresponding screens.

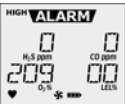
Alarm	Screen	Alarm	Screen
<p>Low Alarm</p> <ul style="list-style-type: none"> • Slow siren • Slow alternating flash • ALARM and target gas bar flash • Vibrator alarm activates 		<p>TWA Alarm</p> <ul style="list-style-type: none"> • Fast siren • Fast alternating flash • ALARM and target gas bar flash • Vibrator alarm activates 	
<p>High Alarm</p> <ul style="list-style-type: none"> • Fast siren • Fast alternating flash • ALARM and target gas bar flash • Vibrator alarm activates 		<p>STEL Alarm</p> <ul style="list-style-type: none"> • Fast siren • Fast alternating flash • ALARM and target gas bar flash • Vibrator alarm activates 	
<p>Multi-Gas Alarm</p> <ul style="list-style-type: none"> • Alternating low and high alarm siren and flash • ALARM and target gas bars flash • Vibrator alarm activates 		<p>Over Limit (OL) Alarm</p> <ul style="list-style-type: none"> • Fast siren • Fast alternating flash • ALARM and target gas bar flash • Vibrator alarm activates 	

Alarm	Screen	Alarm	Screen
Sensor Alarm <ul style="list-style-type: none"> ERR displays 		Automatic Deactivation Alarm <ul style="list-style-type: none"> Eight beeps and eight flashes LOW BATTERY and ALARM display Vibrator alarm temporarily activates OFF displays before deactivating 	
Low Battery Alarm (Confidence beep disabled) <ul style="list-style-type: none"> One beep and one flash every 10 seconds  and ALARM flashes 		Confidence Beep <ul style="list-style-type: none"> One beep every 1-120 seconds (user-defined in Fleet Manager II) Heartbeat <ul style="list-style-type: none">  flashes once every second to verify detector is operating correctly 	
Pump Alarm <ul style="list-style-type: none"> Two beeps and two flashes  and ALARM flashes HIGH displays The vibrator alarm activates 		<p>Note</p> <p>If the Low Alarm Acknowledge option is enabled in Fleet Manager II, the low alarm can be acknowledged and the audible alarm deactivated by pressing . If the alarm escalates to a high, STEL, TWA, or multi-gas alarm, the audible alarm reactivates.</p>	

Note

If enabled, during an alarm condition the **Latched Alarms** option causes the low and high gas alarms (audible, visual, and vibrator) to persist until the alarm is acknowledged and the gas concentration is below the alarm setpoint. The audible alarm can be temporarily deactivated for 30 seconds by pressing , but the LCD continues to display the high peak concentration until the alarm condition no longer exists. Enable/disable **Latching Alarms** in Fleet Manager II. Local regulations may require the **Latching Alarms** option be enabled.

Options Menu

The detector, IR Link adapter, and Fleet Manager II software are required to define options. Refer to the *GasAlertMax XT Technical Reference Guide* and *Fleet Manager II Operator's Manual*. For user and sensor options, refer to the following:

Device Configuration

- **Startup Message Top Line:** Enter a line of text to display on the LCD during startup (maximum 25 characters).
 - **Startup Message Bottom Line:** Enter a line of text to display on the LCD during startup (maximum 25 characters).
 - **Lockout on Self-Test Error** (sensor alarm lock): If a sensor fails during startup and the **Lockout on Self-Test** option is enabled, **Safety Lock On** displays on the LCD and the detector deactivates.
 - **Safe Mode:** If enabled, **SAFE** displays continuously on the LCD unless an alarm condition occurs.
 - **Confidence Beep:** If enabled, the confidence beep provides continuous confirmation that the detector is operating correctly. To define how often the detector beeps (every 1-120 seconds), enter the value in the **Confidence Interval** field. Confidence beep is automatically disabled during a low battery alarm.
 - **Latching Alarms:** Enable to ensure an alarm persists until the alarm is acknowledged and the gas concentrations are below the alarm setpoint. The audible alarm can be temporarily deactivated for 30 seconds by pressing , but the LCD continues to display the high peak concentration until the alarm condition no longer exists.
- **Force Calibration:** If enabled, the detector must be calibrated if a sensor is overdue upon startup. User defined (0-365 days) in the **Calibration Interval** field.
 - **Cal IR Lock** (must use IR device to calibrate): If enabled, the detector automatically auto zeros, but the sensors must be spanned using the IR Link or MicroDock II station with Fleet Manager II.
 - **Force Bump:** If enabled, a bump test must be performed to ensure the sensor(s) are responding correctly to the test gas. User defined (0-365 days) in the **Bump Interval** field.
 - **Location Logging:** If enabled, a series of numbers (1-999) can be entered on the detector to identify gas wells, plants, and other areas that identify the location where the detector is being used.
 - **Force Block Test:** If enabled, a pump block test must be performed during the startup tests.
 - **Datalog Interval (seconds):** Define how often the detector records a sample (every 1-120 seconds).
 - **Confidence Interval (seconds):** Define how often the detector beeps (1-120 seconds) when the **Confidence Beep** option is enabled.
 - **Language:** The LCD displays the screens in **English**, **Français** (French), **Deutsch** (German), **Español** (Spanish), or **Português** (Portuguese). Select the language from the drop-down menu in Fleet Manager II.

Sensor Configuration (H₂S, CO, LEL, and O₂)

- **Sensor Disabled:** Enables/disables the selected sensor.
- **Calibration Gas (ppm):** Define the span gas concentration for each sensor. The span gas concentration must match the span value on the gas cylinder.
- **Calibration Interval (days):** Define the number of days (0-365) when the next calibration is due.
- **Bump Interval (days):** Define the number of days (0-365) when the next bump test is due.
- **Low Alarm (ppm):** Define the low alarm setpoint for each sensor.
- **High Alarm (ppm):** Define the high alarm setpoint for each sensor.
- **TWA Alarm (ppm):** Define the time-weighted average (TWA) alarm setpoint (toxic sensors only).
- **STEL Alarm (ppm):** Define the short-term exposure limit (STEL) alarm setpoint (toxic sensors only).
- **STEL Interval (minutes):** Define the short-term exposure limit (STEL) from 5-15 minutes (toxic sensors only).
- **TWA Period hours (TWA moving average (hours):** The TWA Period option is used to define a time-weighted moving average of accumulated gases over a period of 4-16 hours, to ensure the worker leaves the area when the defined maximum average is accumulated.
- **Correction Factor (%):** Enter the compensation factors for hydrocarbons other than methane. The factor can only be applied if the LEL sensor has been calibrated with methane (LEL only).
- **50% LEL = (%CH₄):** Enter a percentage value to display the LEL reading as %vol., assuming a methane environment (LEL only).
- **Auto-Zero on Startup:** Enable/disable the detector to automatically zero the sensor(s) during startup (H₂S, CO, LEL, and O₂).
- **LEL by Volume CH₄:** If enabled, the detector operates assuming a methane (CH₄) calibration. Enable to read and display %CH₄ values. Disable to read and display %LEL values.
- **5% LEL Over-span:** If enabled, the detector automatically over-spans the LEL sensor by 5% LEL above the determined span gas concentrations to ensure the span surpasses CSA standards.
- **20.8% Base Reading:** When enabled, the detector is configured to detect 20.8% O₂ as ambient air. When disabled, the detector is configured to detect 20.9% O₂ as ambient air.
- **Low Alarm Acknowledge:** If enabled, the audible alarm can be temporarily disabled during a low alarm by pressing . The vibrator, alarm LEDs, and LCD remain operational (toxic and LEL only).

Maintenance

To maintain the detector in good operating condition, perform the following basic maintenance as required.

- Calibrate, bump test, and inspect the detector on a regular schedule.
- Maintain an operations log of all maintenance, bump tests, calibrations, and alarm events.
- Clean the exterior with a soft damp cloth. Do not use solvents, soaps, or polishes.
- Do not immerse the detector in liquids.

Charging the Detector

⚠ Warning

Charge only in a safe area that is free of hazardous gas within temperatures of 32°F-113°F (0°C-45°C).

Charge the battery after each workday. To charge the battery, refer to the following procedures and illustration:

1. Deactivate the detector.
2. Insert the charging adapter plug into an AC outlet.
3. Connect the charging adapter to the detector IR receptacle. Refer to the following illustration.
4. Allow the battery to charge for 6 hours.
5. To reach full battery capacity, allow a new battery to fully charge and discharge three times.

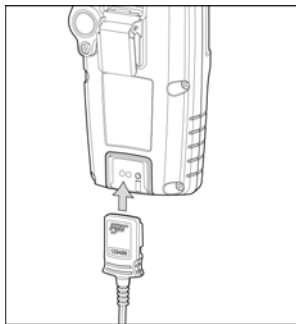

Replacing a Sensor or Sensor Filter

⚠ Warning

To avoid personal injury and/or property damage, only use sensors that are specifically designed for the detector.

Note

Detectors that are configured for 1, 2, or 3 gases may contain a dummy sensor in one of the four sensor locations.

To replace a sensor or sensor filter, refer to the following figure, table and procedures #1-13.

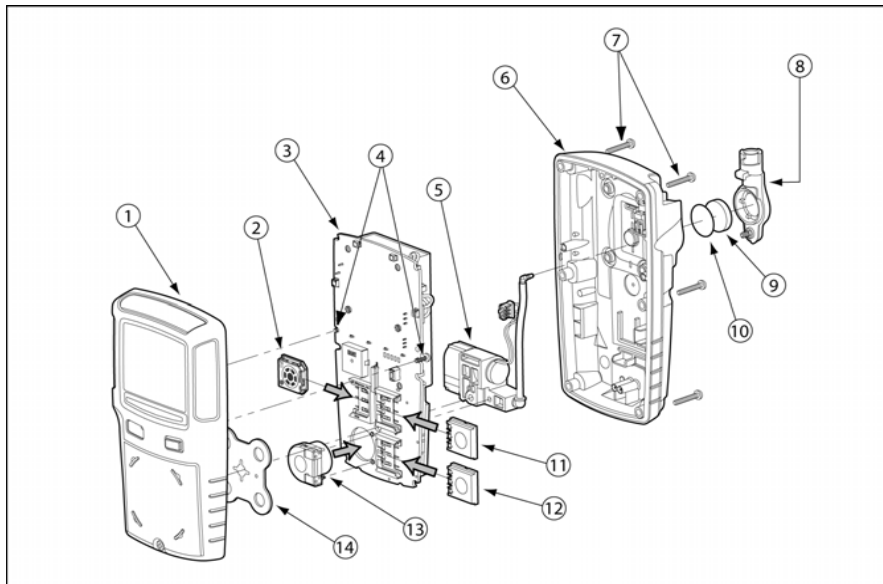

Item	Description
1	Front shell
2	LEL sensor
3	PCB
4	PCB screws (2)
5	Pump
6	Rear shell
7	Machine screws (6)
8	Pump inlet
9	Pump filter (particulate)
10	Moisture filter
11	CO sensor
12	H ₂ S sensor
13	O ₂ sensor
14	Sensor filter

1. Deactivate the detector.
2. Remove the pump inlet screw and the pump inlet.
3. Remove the six machine screws from the rear shell.
4. Because the pump hose is connected to the rear shell and front shell pump, carefully remove the rear

shell by lifting upward and tilting to the left. Both the rear and front shell are laying flat side by side.

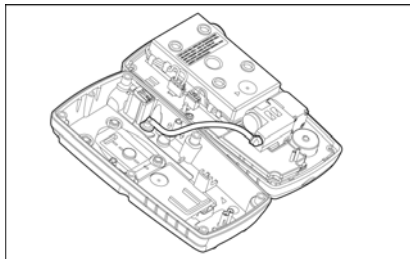

5. Remove the two PCB screws.
6. Lift the PCB upward and tilt to the left. Lay the PCB (sensors facing up) onto the rear shell.
7. Slide the sensor(s) outward to remove (O₂ lift out).
8. Insert the new sensor(s) and replace the sensor filter.
9. Reassemble the detector and replace the two PCB screws.
10. Replace the six machine screws.
11. If required, replace the pump and moisture filter.
12. Replace the pump inlet and the pump inlet screw.

13. Activate the detector and then calibrate the new sensor(s). Refer to [Calibration](#).

Specifications

Instrument dimensions: 13.1 x 7.0 x 5.2 cm
(5.1 x 2.8 x 2.0 in.)

Weight: 300 g (10.6 oz.)

Operating temperature: -20°C to +50°C (-4°F to +122°F)

Storage temperature: -40°C to +60°C (-40°F to +140°F)

Operating humidity: 10% to 100% relative humidity
(non-condensing)

Dust and moisture ingress: IP66/67

Alarm setpoints: May vary by region and are user-defined

Detection range:

H₂S: 0 - 200 ppm (1 ppm increments)

CO: 0 - 1000 ppm (1 ppm increments)

O₂: 0 - 30.0% vol. (0.1% vol. increments)

Combustible (LEL): 0 - 100% (1% LEL increments) or
0 - 5.0% v/v methane

Sensor type:

H₂S, CO, O₂: Single plug-in electrochemical cell

Combustibles: Plug-in catalytic bead

O₂ measuring principle: Capillary controlled concentration
sensor

Alarm conditions: TWA alarm, STEL alarm, low alarm, high alarm, multi-gas alarm, over limit (OL) alarm, low battery alarm, confidence beep, automatic deactivation alarm, and pump alarm

Audible alarm: 95 dB+ at 30 cm variable pulsed beeper with full battery charge

Visual alarm: Red light-emitting diodes (LEDs)

Display: Alphanumeric liquid crystal display (LCD)

Backlight: Activates upon startup and when the pushbutton is pressed; deactivates after 10 seconds. Also activates during an alarm condition and remains lit until alarm ceases

Self-test: Initiated at activation and tests continuously

Calibration: Automatic zero and automatic span

User field options: Startup message, lockout on self-test error, safe mode, confidence beep, latching alarms, force calibration, cal IR lock, force bump, location logging, force block test, set datalog interval, set confidence interval, language selection

Sensor options: Sensor enable/disable, set span calibration values, set calibration interval, set bump interval, set alarm setpoints, set STEL interval, set TWA period, auto zero at startup enable/disable, 5% over span, low alarm acknowledge, oxygen measurement, and combustible gas measurement

Battery operating time:

One rechargeable lithium polymer: 13 hours (typical)

GasAlertMax XT

Operator's Manual

Year of manufacture: The detector's year of manufacture is determined from the serial number. The second and third number after the second letter determines the year of manufacture. E.g., MA 108-000001 = 2008 year of manufacture

Approved batteries:

North America

Approved batteries for GasAlertMax XT product:

Lithium-ion polymer battery as per standards EN50020, UL913, C22.2 No. 157

Rechargeable battery (MX-BAT01)

Lithium polymer -20°C ≤ Ta ≤ +50°C

Temperature code

T4

Battery charger: charging adapter

First-time charge: 6 hours

Normal charge: 6 hours

Warranty: 2 years including sensors

Approvals:

Approved by CSA to both U.S. and Canadian Standards

CAN/CSA C22.2 No. 157 and C22.2 152

ANS/UL - 913 and ANSI/ISA - S12.13 Part 1

CSA Class I, Division 1, Group A, B, C, and D

ATEX CE 0539 (Ex) II 1 G Ga Ex ia IIC T4

KEMA 08 ATEX 0001

IECEx Ga Ex ia IIC T4

This equipment has been tested and found to comply with the limits for a Class B digital device, pursuant to Part 15 of the FCC Rules and ICES-003 Canadian EMI requirements. These limits are designed to provide reasonable protection against harmful interference in a residential installation. This equipment generates, uses and can radiate radio frequency energy and, if not installed and used in accordance with the instructions, may cause harmful interference to radio communications. However, there is no guarantee that interference will not occur in a particular installation. If this equipment does cause harmful interference to radio or television reception, which can be

determined by turning the equipment off and on, the user is encouraged to try to correct the interference by one or more of the following measures:

- Reorient or relocate the receiving antenna.
- Increase the separation between the equipment and receiver.
- Connect the equipment into an outlet on a circuit different from that to which the receiver is connected.
- Consult the dealer or an experienced radio/TV technician for help.

Regulators Used For the GasAlertMax XT Detector

Calibrations and bump tests can be performed using either of the following regulators:

- 0.5 l/min regulator
- Demand flow regulator

⚠ Warning

Calibration cylinders that are used with a demand flow regulator must meet the following maximum inlet pressure specifications:

- Disposable cylinders 0-1000 psig/70 bar
- Refillable cylinders 0-3000 psig/207 bar

Replacement Parts and Accessories

Model No.	Description	Qty
REG-0.5	0.5 l/min regulator	1
REG-DF-1	Demand flow regulator	1

Wear yellow. Work safe.

iERP: 125741

D6171/0 [English]

© BW Technologies 2008. All rights reserved.