



**AW-LAKE**  
PROCESS FLOW MEASUREMENT



---

► **ProScan In-Line Process Sensor**  
Installation, Operating &  
Maintenance Manual

# Table of Contents

<b>Product Description</b> .....	3
Principle of Operation.....	3
Features.....	3
Technical Specifications.....	4
<b>Preliminaries</b> .....	4
Standard Shipments.....	4
Unpack and Check Contents.....	4
Electrical Connections.....	5
Operation.....	6
Applying Power.....	6
<b>Installation</b> .....	7
Deadleg.....	7
Installation Site.....	7
Vertical.....	8
Horizontal.....	8
Straight Sections.....	8
Installations Not Recommended.....	8
Clamp Connection Gasket.....	8
Connect.....	8
<b>Calibration Verification</b> .....	8
<b>Calibration Procedure</b> .....	10
<b>Sensor Offset and Span Calibration</b> .....	11
<b>Disclaimer</b> .....	19

# Product Description

ProScan is an in-line optical sensor that mounts directly to the process line, providing real-time information about the process.

ProScan can accurately detect the point of transition from water to product, which is the primary application. Depending on the degree of solids difference between two materials, it can also detect a product-to-product transition. And for products such as skim, 1 percent, 2 percent and whole milk, ProScan can act as a monitor of milkfat percentage and an indicator of product quality.

The most common calibration entered into ProScan includes points for water, skim milk, 1 percent milk, 2 percent milk, whole milk and a maximum response standard equal to 20 mA.

The 3A Certified ProScan also has uses in the brewing, pharmaceutical, and juice processing industries. The device accurately monitors product concentration and can help processors recover as much product as possible before a cleaning cycle begins. It can also help to ensure equipment adds costly chemicals at the appropriate time.

The ProScan sensor assists in determining if fluid should be added to recovery tanks or sent to the drain, and is an excellent monitor of BOD loading on waste lines. Solid construction means the ProScan Sensor stands up to the high temperatures and temperature fluctuations.

## Principle of Operation

Utilizing advanced optical technology, ProScan sends a beam of light into the process and measures the backscatter, which is proportional to solids concentration. The device's internal microprocessor then converts the scatter to a linearized 4–20 mA output, which easily links to a PLC, DCS or data logger.

## Features

- 3A Certification
- Real-time process control
- Detects phase transitions
- Stainless steel construction
- Sapphire lens

- Sanitary clamp connections
- NEMA 6 / IP67 enclosure
- Easy to install, set up and maintain

## Technical Specifications

### Output

4-20 mA

### Power Consumption

0.45 Watts

### Supply Voltage

15-24 VDC

### Standard

3-A Sanitary Standard, 46-03

### Housing

NEMA 6 / IP67 enclosure

### Optical Lens

Sapphire

### Lens Seal

FDA approved silicone rubber

### Process Connections

1-1/2", 2", 2-1/2", 3" Sanitary Clamp

### Temperature Rating

32-212°F (0-100°C) - constant

32-300°F (0-149°C) - intermittent

### Body & Connector

316L stainless steel

## Preliminaries

### Standard Shipments

Unless specified otherwise, ProScan sensors are shipped with default values covering a span of 4 to 20 mA. To get accurate results, it is recommended to calibrate the Proscan to samples of the materials being measured. AW-Lake will offer customer specific calibrations at an added cost and customers must specify or provide the sample materials.

### Unpack and Check Contents

Upon receipt of the shipment, carefully remove all items from the shipping package and compare the contents to the shipping documents.

Also check:

- The ProScan sensor and other components for any damage that may have occurred during shipping.
- To make sure the sapphire lens is clean and undamaged. (If the lens needs to be cleaned, clean it gently with a mild soap solution and a soft, clean cloth.)
- The sensor's electrical connector; it should easily mate with the connector pins on the sensor body.
- To make sure the threaded collar allows a snug, secure fit when fully engaged.

## Electrical Connections

ProScan has a 5-pin electrical connector. The electrical connection scheme is shown in Figure 9, page 20.

If you purchased the molded, NEMA-6 electrical connector and cable from AW Gear Meters, simply connect the cable as provided.

If you are using the Hirschmann connector (Part Number 932 878-100 ELST 512 PG9 ([www.hirschmannusa.com](http://www.hirschmannusa.com))) and need to make a cable connection, please read the following steps.

The most common wiring scheme for ProScan is a 3-wire connection:

- Pin 2 is the mA output
- Pin 3 is the 12 to 24 VDC power supply
- Pin 4 is the ground (negative side of the supply).

A 4-wire connection can also be used to connect ProScan. In this wiring scheme, connect

- Pin 1 (the negative side of the mA output)
- Pin 2 (positive side of the mA output)
- Pin 3 (12 to 24 VDC power supply)
- Pin 4 (ground).

Pin 1 is the negative side of the mA output and is connected internally to Pin 4. This makes it more convenient if you want to make a 4-wire connection as shown in Figure 1, page 8.

**NOTICE:** Pin 5, located in the center of the connector, is not used.

Once you make the connections inside the electrical connector, tighten the threaded cord grip on the connector. This helps keep moisture from entering.

Figure 1: Electrical Connections

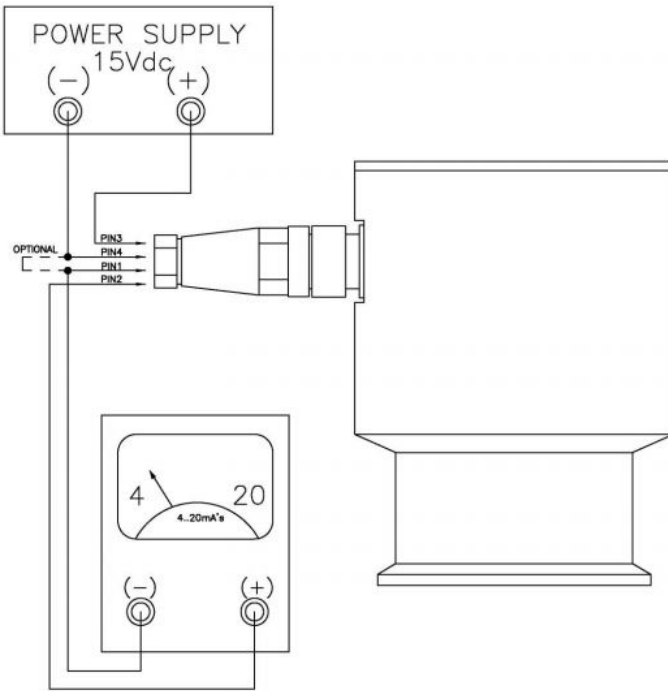

## Operation

Once ProScan is calibrated and you make the proper electrical connections, the sensor is ready for operation. Before attaching the sensor to the process line, however, it is advisable to perform a quick check of the unit's operation.

You must connect the sensor output to a digital display, multimeter or some other electronics that allows you to monitor the ProScan's mA output.

## Applying Power

To view the unit's internal electronics board, remove the screw cap on the sensor (see Figure 3, page 15). When you apply power to the ProScan sensor, the green LED on the unit's internal electronics board blinks.

**NOTICE:** When the sensor is operating within the current calibration range, the Green LED on the sensor's electronics board blinks alone. When over-range, the Red and Green LEDs blink, and when below range, the Green and Yellow LEDs blink.

## Installation

ProScan has a conventional sanitary clamp connector that attaches directly to a tee or saddle in the process line or vessel. ProScan comes in standard 1.5, 2, 2.5 and 3 inch sizes.

You can install ProScan in a wide variety of configurations, including vertical and horizontal process lines and tanks. To optimize the performance of the sensor, it is important to:

- keep the deadleg as short as possible on the tee connection, and
- choose an installation site that minimizes air or sediment from collecting on the sensor's lens.

### Deadleg

To minimize deadleg, cut the tee back so the ProScan lens is as close as possible to the process stream.

In most cases, it is possible to cut the tee back and have a resulting deadleg of 1 to 2 inches. The shorter the deadleg, the better.

### Installation Site

Select an installation site and orientation that minimizes the possibility of air or sediment interfering with the sensor's readings.

#### Vertical

Vertical sections of process lines are excellent installation sites, whether the flow is down or up.

#### Horizontal

Another excellent installation site is a 90-degree elbow on a horizontal line. In this case, position the ProScan device so the fluid flows directly at the sensor's lens.

## Straight Sections

If installed on a straight section of horizontal process line, place ProScan so it looks sideways into the process stream, not up or down.

## Installations Not Recommended

Two installations not recommended are:

- on the top of horizontal process lines, where air has a tendency to accumulate,
- on the bottom of horizontal process lines, where sediment can accumulate.

## Clamp Connection Gasket

The clamp connection requires a gasket between ProScan and the tee. In most cases, the customer provides the gasket and the tee. Customers can purchase these products from AW Gear Meters, if necessary.

## Connect

Connect the sensor to the process pipe with the appropriate sanitary gasket and clamp. Orient the sensor so that the electrical connector points toward the floor (see Figure 2, page 14).

**CAUTION: The sapphire lens can be damaged if struck by sharp or hard objects or if the sensor is dropped during installation. Take care when connecting the sensor to the tee so the lens isn't damaged.**

## Calibration Verification or Test with Your Samples

The factory has default values in the unit that are similar to the various types of dairy products. It is recommend that the customer do their own calibration with sample materials before putting the unit into use. The factory can calibrate the units at an additional cost and material samples must be provided.

**NOTICE: A common setup is to close off the bottom leg of the tee with an end cap, attach ProScan to the middle leg, and pour the sample in the top leg.**

1. Obtain samples of all products that this system will process. You will need enough of each to fill a tee as shown in Figure 6, page 18.
2. Connect ProScan to the required power supply. Attach the sensor to a suitable test stand, such as a sanitary tee (shown on page 14).



3. Be sure to wire the ProScan device properly to either the receiver or to a Multi-meter so you can view the corresponding signal output from the unit. When you supply power to the ProScan, the green LED on the electronics board blinks.

**CAUTION: Be careful not to dilute or otherwise contaminate the samples between readings. Also, if the highest degree of accuracy is desired, make sure the samples are at the same temperature as they will be in the process line.**

4. Starting with the product containing the least amount of solids of lowest turbidity, fill the tee as shown.
5. Record the output for this product, then move to the next, ending with the product containing the greatest amount of solids.

**NOTICE: When the sensor is operating within the current calibration range, the Green LED on the sensor's electronics board blinks alone. When over-range, the Red and Green LEDs blink, and when below range, the Green and Yellow LEDs blink.**

**The resulting profile corresponds to the outputs from the unit at each of the various products. Use these values as the reference for programming a receiver or to verify calibration of the ProScan sensor. Changes in product properties (solids content) are a common cause for discrepancy. If observed, follow the Calibration Procedure below.**

## Calibration Procedure

If you want to adjust the calibration, follow this procedure:

1. Obtain samples of all products that will be processed in this system. If using liquid sample, you need sufficient volume of each to fill the tee. Calibrate them in increasing order of concentration. ProScan allows you to choose a variety of calibrations, from a 2-point calibration to a 9-point calibration.
2. Be sure you wire the unit to either the receiver or to a Multi-meter so you are able to view the corresponding signal output from the unit.
3. Remove the ProScan lid by turning it counterclockwise. This allows access to the electronics board. Refer to Figure 3 on page 15 to locate the Calibration Switch, Entry Key and Offset Adjustment Keys.

**CAUTION: Be careful not to damage the rubber o-ring.**

4. As shown in Figure 6 on page 14, fill the tee with clean water, or another fluid that you desire to be the 4 mA reference (if a value other than 4 mA is desired for the base value, please see SENSOR OFFSET and SPAN CALIBRATION section below).
5. Observe the mA reading that ProScan produces with the 4 mA reference sample. If the output is 4 mA, there is no need to adjust. If you desire to change the zero point, turn the calibration switch to position "0", and press and hold the ENTRY key for approximately two seconds. This stores the new value as 4mA.
6. Remove the water, or optional base product, and fill the tee with the next highest solids content.**NOTICE: So as not to introduce error in calibration, it is recommended you rinse the tee with water to clean any residue of the previous product from the face of the sensor.**
7. Turn the CALIBRATION SWITCH to position 1. Press and hold the ENTRY key for approximately two seconds. The sensor output is now set to 20.00 mA (or the span setting).
8. Repeat step 8, incrementing the CALIBRATION SWITCH by one, until you have calibrated all points (maximum is to point 8). As you add points, each addition becomes the new 20.00 mA top end. Each previously entered point is linearly re-scaled.
9. In general, a five (5) point calibration is sufficient to provide proper output resolution. You may use calibration point 0 to 8. Point 9 is reserved for the Sensor Output Reference, described below.
10. To obtain output values, place the sensor again into each of the test liquids. With each product, record the resulting current output from the transmitter. The resulting profile corresponds to the outputs from the unit at each of the various products.
11. You can now use these values to program a receiver.

# Sensor Offset and Span Calibration

The ProScan sensor is typically prepared at the factory with a default value of 4.00 mA output for the “base reference” position “0,” and 20.00 mA for span position “5.” For most applications, it is recommended that the unit be used in this configuration. The following procedure illustrates steps to verify or modify these values.

1. Remove the screw cap on sensor.

**CAUTION: Be careful not to damage rubber o-ring.**

2. Refer to the Figure 3 on page 15 to locate the Calibration Switch, Entry Key and Offset Adjustment Keys.
3. If you wish to change the span value, place the Calibration switch in Position “9” and press the “up” or “down” offset adjustment keys until you obtain the desired value; then press and hold the ENRTY key for approximately 2 seconds.
4. If you wish to change the “base reference” value, place the Calibration switch in Position “0” and press the “up” or “down” keys until you obtain the desired value; then press and hold the ENTRY key for approximately 2 seconds.

This following illustrates how you can tailor the ProScan calibration to meet different process control needs.

Figure 4 on page 16 shows an example of a multi-point calibration. For this example, milk samples were used. Water = 4 mA, skim milk = 8 mA, 1% milk = 12 mA, 2% milk = 16 mA and whole milk = 20 mA. The calibration selector switch was 0 position for water, 1 position for skim milk, 2 position for 1% milk, 3 position for 2% milk and 4 position for whole milk.

Figure 5 on page 17 shows a slightly different example of a multi-point calibration. In this case, a dairy customer wanted a greater degree of sensitivity near 1% milkfat; a 6-point calibration was used, which emphasized the 1% to 1.3% milkfat concentration. All that was necessary was to prepare samples of the proper concentration. The ProScan calibration linearizer divided the 4 to 20 mA span into five sections of 3.2 mA each, including the key range in the middle of the graph.

If questions arise at any time, please contact AW-Lake Company.

Figure 2: Proscan Sensor attached to a sanitary T, electrical connection facing floor



Figure 3: Back of sensor showing LEDs, connector, calibration switch, entry key, adjustment keys, etc.

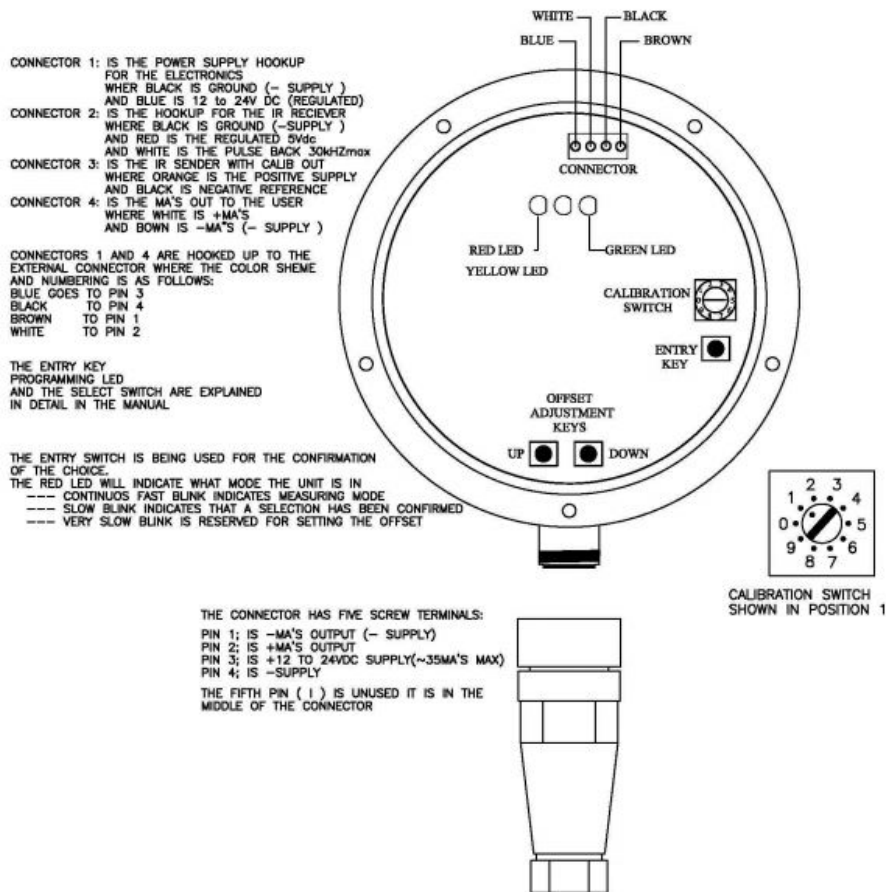

Figure 4: Calibration lineariser, 4 point

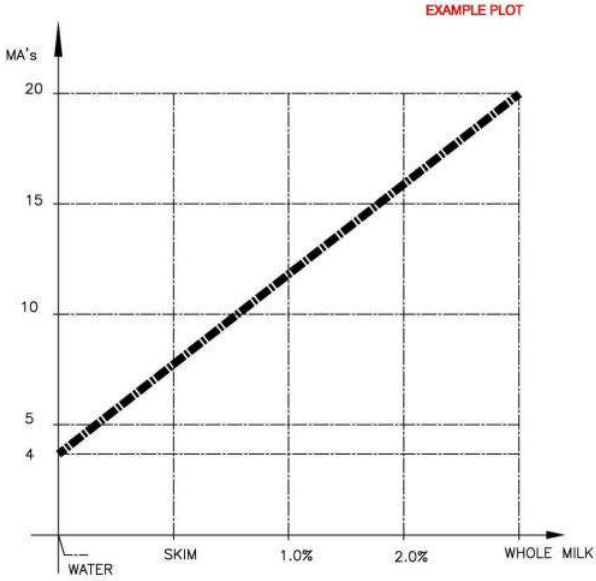

Figure 5: Calibration lineariser, 5 point

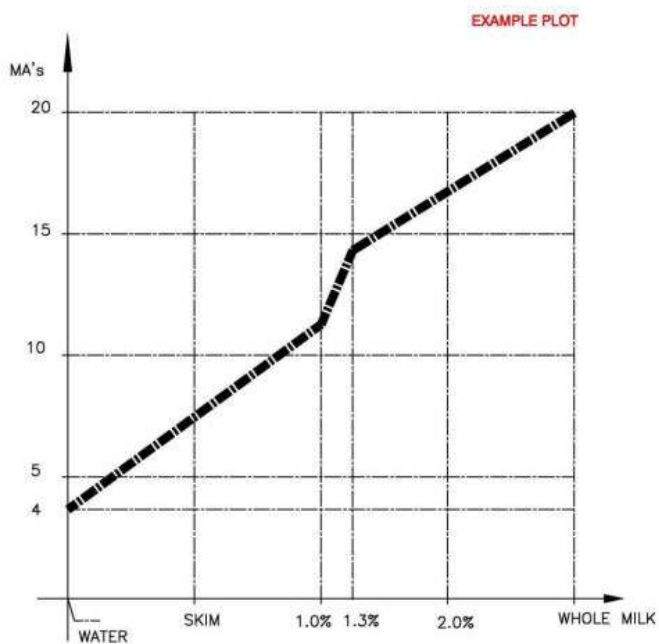

Figure 6: Recalibration

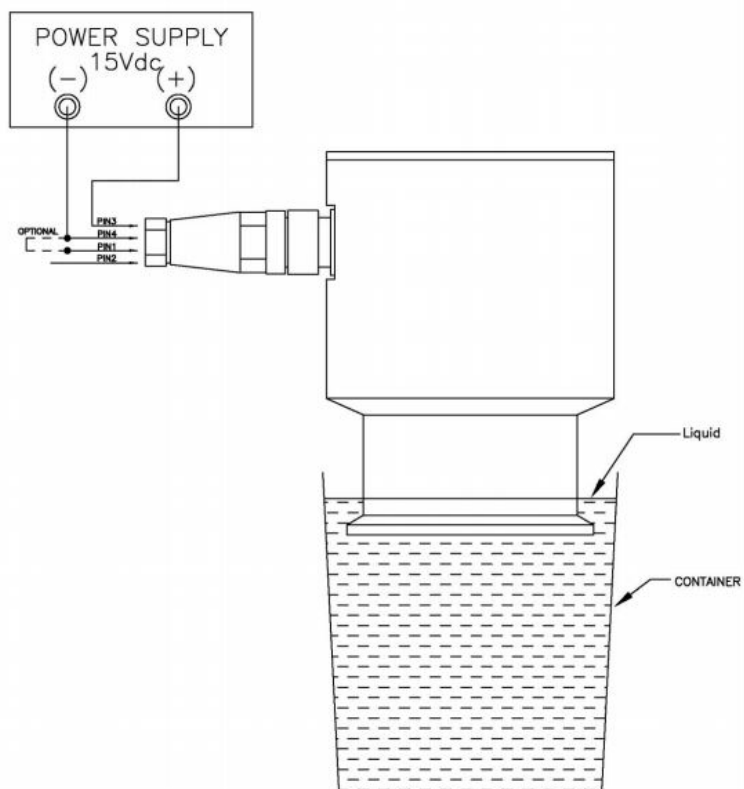



Figure 7: Factory calibration information

MATERIAL USED TO CALIBRATE \_\_\_\_\_

DATE \_\_\_\_\_

CALIBRTED BY \_\_\_\_\_

CALIBRATION POINT 1 \_\_\_\_\_ mA's

CALIBRATION POINT 2 \_\_\_\_\_ mA's

CALIBRATION POINT 3 \_\_\_\_\_ mA's

CALIBRATION POINT 4 \_\_\_\_\_ mA's

CALIBRATION POINT 5 \_\_\_\_\_ mA's

CALIBRATION POINT 6 \_\_\_\_\_ mA's

CALIBRATION POINT 7 \_\_\_\_\_ mA's

CALIBRATION POINT 8 \_\_\_\_\_ mA's

BASE LINE \_\_\_\_\_ mA's

Figure 8: Five-pin connector with digital and analog output options

# PROSCAN

MODEL #	DIMENSION "A"	HOUSING	LENS	GASKET	WEIGHT
1.50" PROSCAN	1.984"	316 SS	SAPPHIRE	FDA SILICONE	TBD
2.00" PROSCAN	2.516"	316 SS	SAPPHIRE	FDA SILICONE	3LB
2.50" PROSCAN	3.047"	316 SS	SAPPHIRE	FDA SILICONE	TBD
3.00" PROSCAN	3.579"	316 SS	SAPPHIRE	FDA SILICONE	TBD

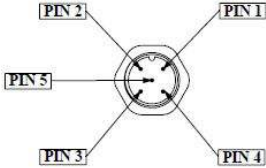

	ANALOG	
PIN 1	-mA Output	
PIN 2	+mA Output	
PIN 3	+15 - 24 VDC Supply	
PIN 4	- Supply	
PIN 5	No Connection	

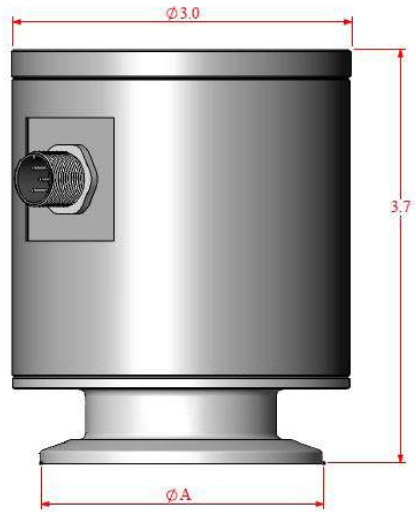

**NOTE:**

All Proscan models have option for either analog (default) or digital output. Proscan's are 3-A Authorized.

# Disclaimer

AW-Lake Company has reviewed this manual thoroughly so it is easy to use. All statements, technical information and recommendations in the manual or related documents are believed to be reliable, but the accuracy and completeness thereof is not guaranteed or warranted. Also the information in this manual is subject to change without notice. All schematics and details are the product of AW-Lake Company. No reproduction, alteration or disclosure of this material or any other proprietary product detail, outside the intended user, or any third part, is allowed without prior written consent from AW-Lake Company. In no event will AW-Lake Company's Meters be liable to the customer for any damages, including any lost profits, lost savings or inability to use such product, even if AW-Lake Company has been advised of the possibility of such damages, or for any claim by any other party.



414.574.4300 | [www.aw-lake.com](http://www.aw-lake.com)  
2440 W. Corporate Preserve Dr. #600, Oak Creek, WI 53154 USA