

ALTOSONIC UFM 610 P Portable system

Installation and
operating
instructions

ALTOSONIC
UFM 610 P

The solution for Clamp-on Ultrasonic Flow Measurements

- Compact light weight
- All components in one carrying case
- Extended diameter range
- Pipe wall temperature measurement as a standard

PRELIMINARY



All rights reserved. No part of this publication may be copied or published by means of printing, photocopying, microfilm or otherwise without prior written consent of KROHNE Altometer. This restriction also applies to the corresponding drawings and diagrams.

KROHNE Altometer has the right to change the parts or specifications at any time without prior or direct notice to the client. The contents of this publication are subject to change without notice.

This publication is to be used for the standard version only. Thus KROHNE Altometer cannot be held responsible for any damage resulting from the incorrect application of this publication to the version actually delivered to you.

For additional information regarding configuration, maintenance and repair, please contact the technical department of your supplier.

This publication has been written with great care. However, KROHNE Altometer cannot be held responsible, either for any errors occurring in this publication or their consequences.

LIST OF CONTENTS

1. INTRODUCTION 5

- 1.1 Fast Track Set Up Procedure 5

2. HARDWARE..... 9

- 2.1 Connectors..... 9
- 2.2 UFM 610 P parts & accessories 10
- 2.3 Charger (only use the charger supplied) 10
- 2.4 Battery 10
- 2.5 Keypad 10
- 2.6 Temperature indication/range 11
- 2.7 Transducers..... 11
- 2.8 Separation distance..... 13
- 2.9 Attaching the transducer..... 13
- 2.10 Ultrasonic couplant 15
- 2.11 Fluid types 15

3. PROGRAMMING/MAIN MENU 16

- 3.1 Main menu..... 16
- 3.2 Quick start 16
- 3.3 View/edit site data..... 19
- 3.4 Select sensorset 21
- 3.5 Data logger (see also KEYPAD OPTIONS-data logger) 23
- 3.6 Download data to Windows '95 27
- 3.7 Download data to Windows 3.1 29
- 3.8 Main menu set up RS232..... 31
- 3.9 Set up UFM 610 P..... 32
- 3.10 Main menu read flow 34

4. KEY PAD OPTIONS..... 36

- 4.1 Logger 36
- 4.2 4-20 mA Key 37
- 4.3 RS232 output key..... 38
- 4.4 Delete key..... 38
- 4.5 Pulse output key..... 38
- 4.6 Options key..... 39

5. STATUS/ERROR/WARNING MESSAGES 43

- 5.1 Status messages..... 43
- 5.2 Error messages..... 43
- 5.3 Warning messages..... 43
- 5.4 Other messages 44

6. APPLICATION INFORMATION 47

6.1	Transducer	48
6.2	Mounting the transducers	49
6.3	Liquid conditions	51
6.4	Reynolds number	51
6.5	Propagation velocity.....	52
6.6	Maximum flow.....	52
6.7	Application temperature	52
6.8	Flow range.....	52
6.9	Liquid sound speed	54
6.10	Solid sound speeds	58

7. TECHNICAL DATA..... 59

8. CE MARKING 59

9. WARRANTY 60

WARNING!!

Users should ensure or note that:

- 1. The UFM 610 P is not certified for use in hazardous area**
- 2. The local site safety regulations are complied with**
- 3. Work is carried out in accordance with the health & Safety at Work Act 1974**

1. INTRODUCTION

The UFM 610 P is a portable flowmeter designed for use on liquid flows in full pipes, which utilise “Clamp-On” Transducers. Easy to use with rugged packaging, the UFM 610 P features a large easy to read Graphics Display with backlighting. A simple FAST TRACK set up procedure; Simple to follow keypad; IP65 Instrument case with IP65 rated sockets; Guide rail assembly including magnets (if required) for steel pipes above 89mm (3½”) diameter.

Other features incorporated into the UFM 610 P are:

- 1) 112k memory logger
- 2) RS232 output
- 3) Pulse output
- 4) 4-20mA or 0-20mA output
- 5) 24hr Battery (rechargeable)
- 6) Self checking facilities
- 7) Battery management
- 8) Continuous signal monitoring

The instrument displays volumetric flow rate in M³/hr, M³/min, M³/sec, g/min, kg/hr, USg/hr, USkg/hr, l/min, l/sec and linear velocity in metres and feet per second. When in flow mode the total volume both positive and negative will be displayed, up to a maximum 12-digit number.

1.1 Fast Track Set Up Procedure

The Standard UFM 610 P is supplied in a carrying case and laid out as shown in Figure 1. Transducer sets “A” and “B” are standard. Transducer set “C” is an optional extra. A further transducer set “D” is also available but will be supplied in a separate carrying case. The following simple guide will enable the user to quickly set up the meter to measure flow. Additional data on the facilities available and many useful hints are contained in the latter sections of this manual.

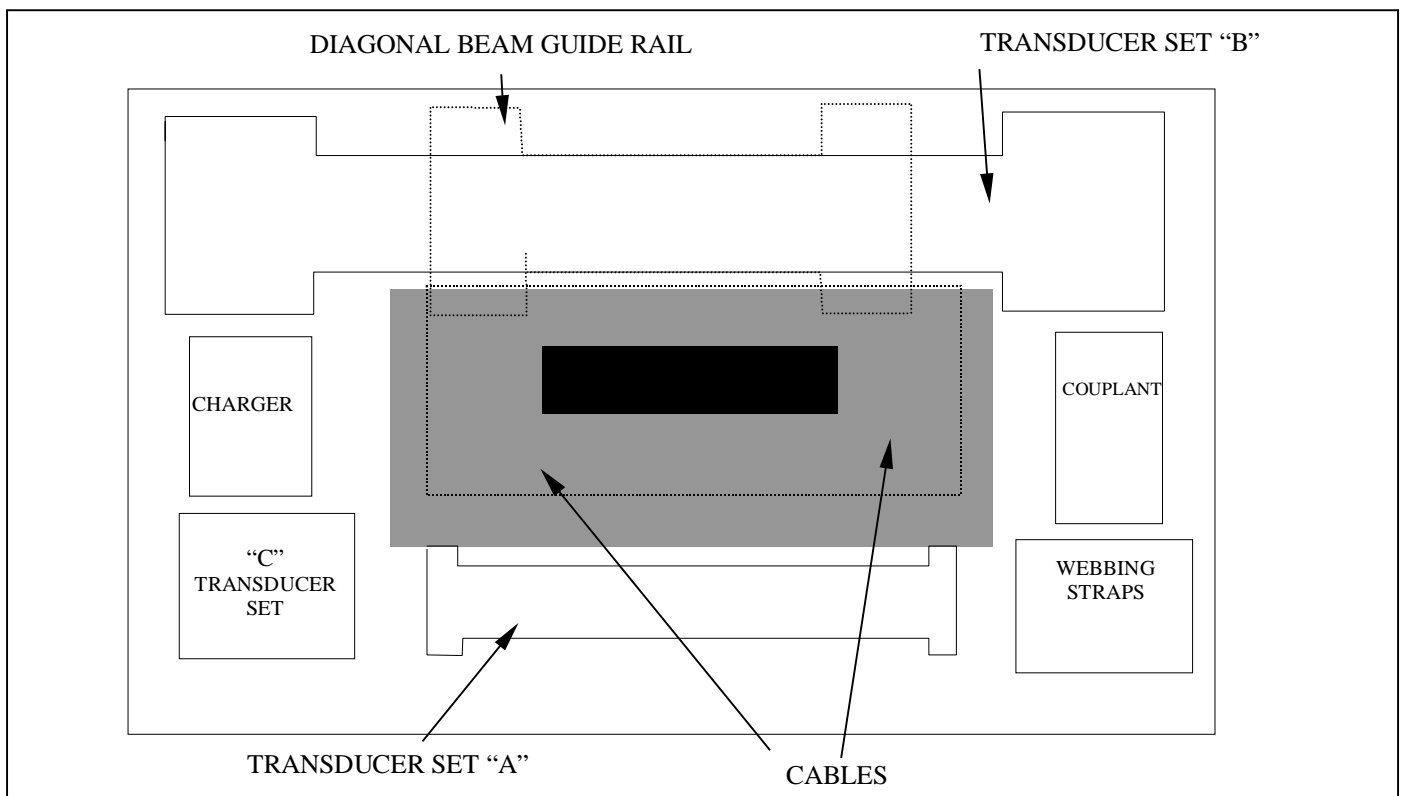

Figure 1

SWITCH ON...

CHECK BATTERY LEVEL	IF THE BATTERY SYMBOL IS FULL, THE UNIT IS CHARGED	PRESS ENTER
----------------------------	--	-------------

(See 2.4)

QUICK START		PRESS ENTER
--------------------	--	-------------

(See 3.2)

DIMENSION UNITS	SELECT UNITS REQUIRED	PRESS ENTER
------------------------	-----------------------	-------------

(See 3.2)

OUTSIDE DIAMETER	ENTER DATA	PRESS ENTER
-------------------------	------------	-------------

(See 3.2)

PIPE WALL THICKNESS	ENTER DATA	PRESS ENTER
----------------------------	------------	-------------

(See 3.2)

PIPE LINING THICKNESS	ENTER DATA	NO LINING PRESS ENTER
------------------------------	------------	-----------------------

(See 3.2)

PIPE WALL MATERIAL	SELECT USING SCROLL KEYS	PRESS ENTER
---------------------------	---------------------------------	-------------

(See 3.2)

PIPE LINING MATERIAL	THIS WILL ONLY BE DISPLAYED IF A THICKNESS HAS BEEN ENTERED. SELECT USING SCROLL KEYS	PRESS ENTER
-----------------------------	--	-------------

(See 3.2)

FLUID TYPE	SELECT USING SCROLL KEY	PRESS ENTER
-------------------	--------------------------------	-------------

(See 3.2)

- The instrument selects the appropriate guiderail using the data entered and now displays the following. The sensor set can be "A", "B", "C" or "D" and the mode Reflex or Diagonal.

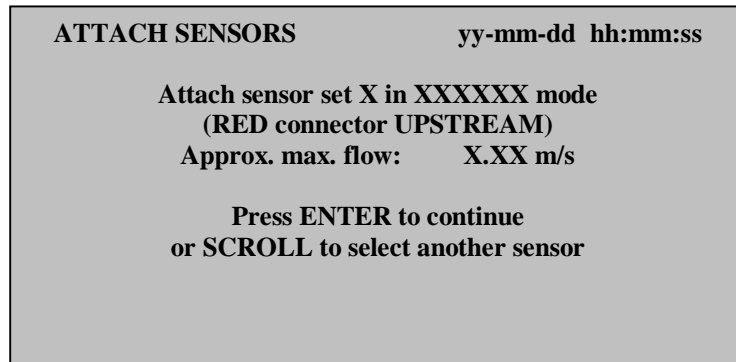

- Take the guiderail selected by the instrument out of the case, retract the sensor blocks back into the guiderail by turning the knurled knobs clockwise. If transducer "C" is selected and these blocks are available, remove "B" transducer set and replace with "C" transducer set.
- Apply couplant to both sensor blocks as shown, then attach to the pipe using the appropriate mounting hardware.

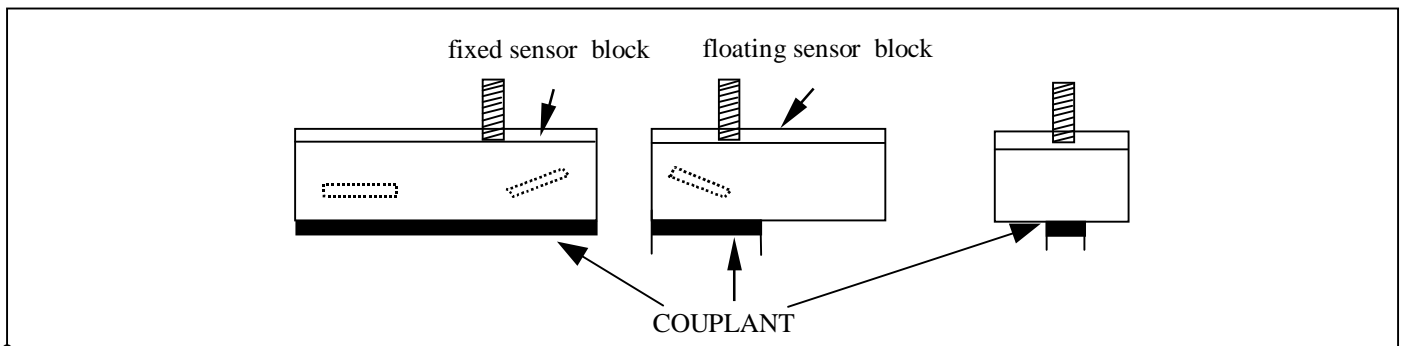

Figure 2

- In most cases the guide rail selected will suit the application. The user can choose another rail and/or sensors to increase sensitivity, signal strength or change flow range (see 3.4.1 – Select Sensor Set).

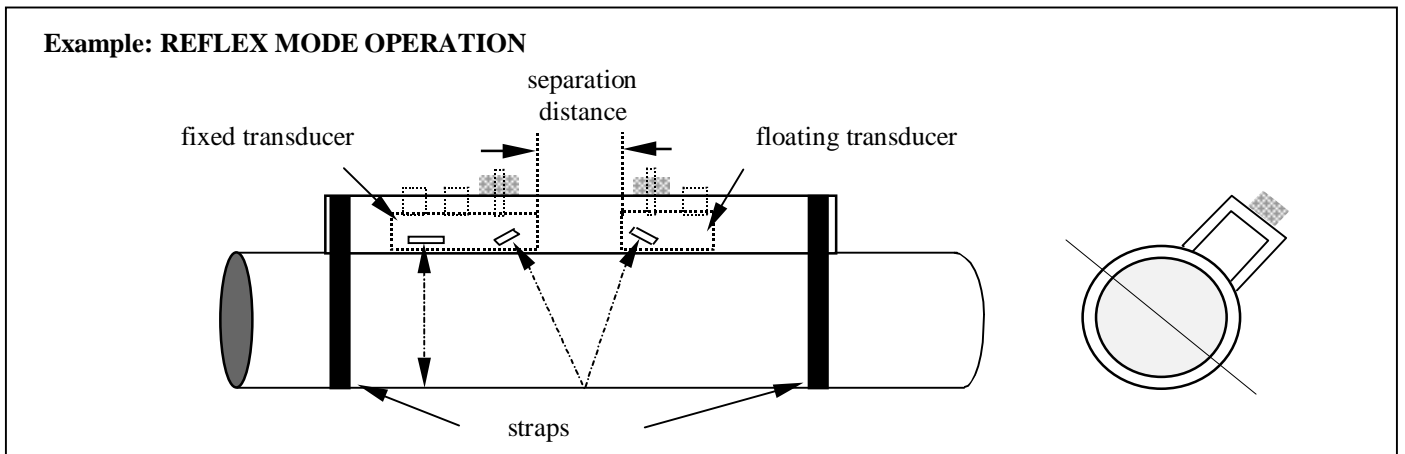

Figure 3

NOTE:

If the instrument has selected a guiderail assembly to work in **DIAGONAL MODE** the floating transducer has to be removed and placed on the opposite side of the pipe, using the diagonal beam rail and the appropriate mounting hardware (See 2.9 - ATTACHING THE TRANSDUCERS).

- Connect the red/blue and black sensor cables to both the electronics and the guiderail assembly. The red cable indicates +ve flow if upstream.
- Attach to the pipe as shown in figure 3 and turning the knurled knob anti-clockwise, screw the fixed transducer to the pipe, making finger tight contact.
- Press ENTER and the display will show the separation distance in mm.
- Set the separation distance (see figure 3) by sliding the floating transducer along the scale until the front edge of the block is at the recommended distance. Now turn the knurled knob anti-clockwise, until in finger tight contact with the pipe surface.

- Press ENTER to read flow.
- Flow units can be changed by pressing the appropriate key. An additional key press will change the timescale of the reading - hr/min/sec.

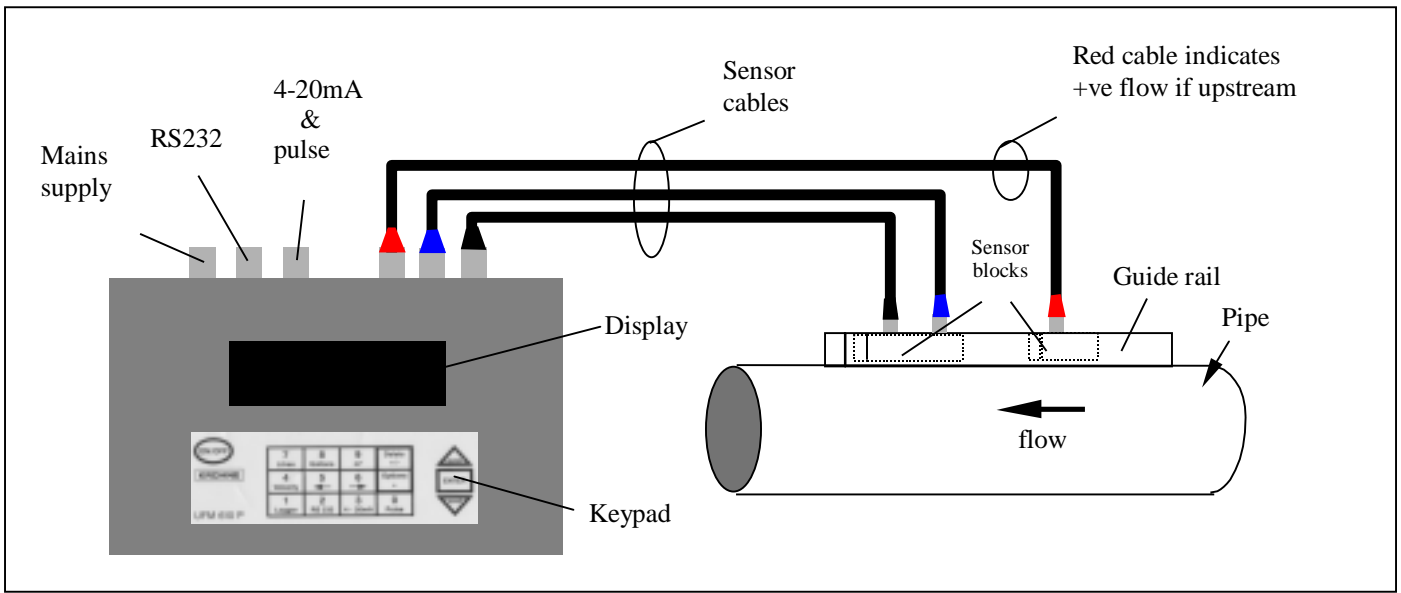

Figure 4

2. HARDWARE

2.1 Connectors

There are six connectors on the electronic housing, three of which are directly connected to the transducer assemblies and three are for the output facilities.

NOTE: To remove the cable connectors from the sensor blocks, fully retract each block into the guide rail by turning the knurled knob clockwise. DO NOT pull on the cables.

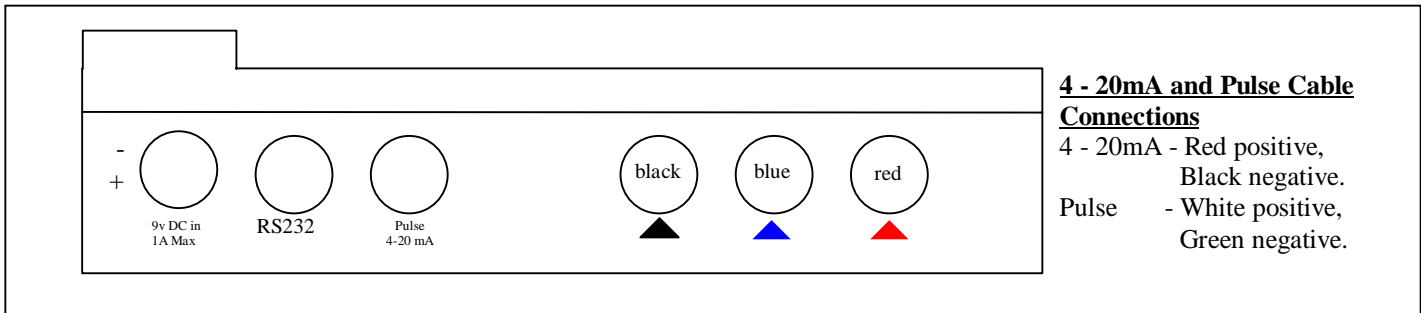
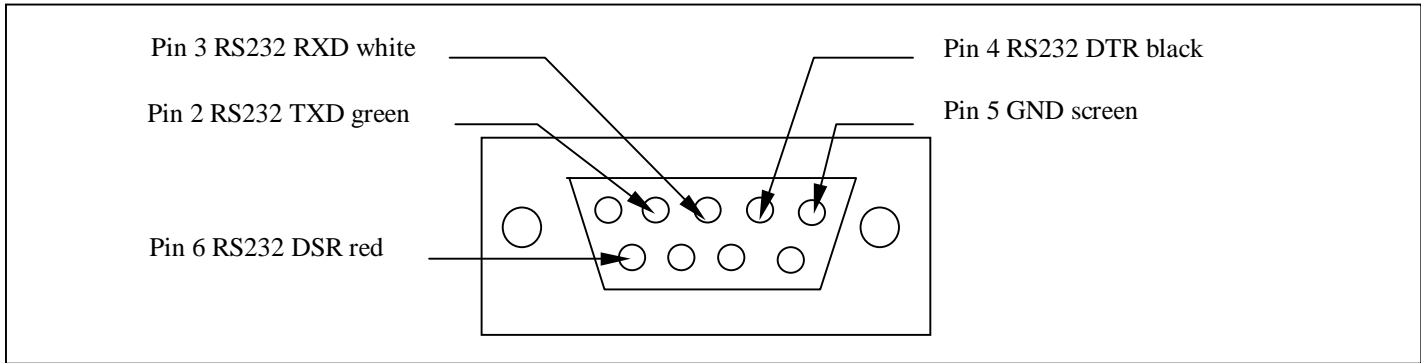

Figure 5

RS 232 CONNECTORS

9 way "D" plug viewed from reverse



5-pin plug viewed from reverse

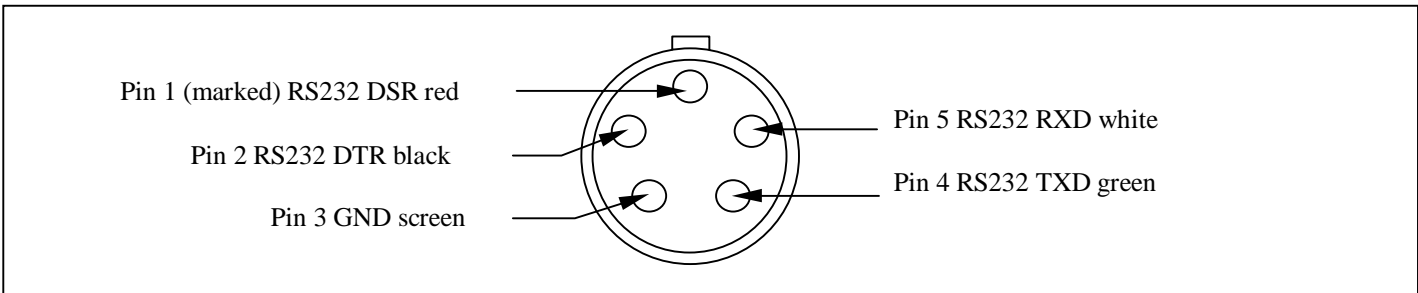

2.2 UFM 610 P parts & accessories

The UFM 610 P is supplied in a rugged IP65 carrying case. The equipment is housed in a foam insert to give added protection for transportation.

STANDARD PARTS	
Electronic instrument with backlit graphic display	Logger included as standard.
Guide Rail Assembly "A"	Includes sensors for pipe ID 13mm to 89mm. Temp. range -20°C to +100°C.
Guide Rail Assembly "B"	Includes sensors for pipe ID 90mm to 1000mm. Temp. range -20°C to +100°C.
Guide Rail for use in Diagonal Mode	
Ultrasonic couplant	
Power supply - with UK, US, European adapters	110/240 VAC.
Manual	
Large pipe straps	4 Supplied as standard.
Sensor cables	3 metres.
Other cables	4-20mA, Pulse Output, RS232-C.

OPTIONS	
Guide Rail Assembly "A"	Includes sensors for pipe ID 13mm to 89mm. Temp. range -20°C to +200°C.
Guide Rail Assembly "B"	Includes sensors for pipe ID 90mm to 1000mm. Temp. range -20°C to +200°C.
Magnetic assembly	For the Diagonal and "B" guide rail Assembly.
Transducer set "C"	High Velocity Transducers for pipes 300mm-2000mm, in guide rail "B". Temp. range -20°C to +100°C or -20°C to +200°C.
Transducer kit "D"	Sensors include ratchet straps for pipes 1000mm to 5000mm. Temp. range -20°C to +80°C.
Straps	Extra webbing straps are available on request.
Calibration certificate	NAMAS accreditation.

2.3 Charger (only use the charger supplied)

The battery takes 15 hours to fully charge. When the instrument is charging but switched off the display will read **CHARGING** and display a battery and plug symbol. When the instrument is in flow mode, the fact that the battery is charging will be displayed under **Battery**. The instrument also displays a "plug" symbol when connected to the mains in flow mode.

2.4 Battery

When you first receive your unit put the battery on charge for a minimum of 15hrs. When fully charged the battery will last up to 24hrs, depending on the outputs used and how often the back light is operated. If the backlight is enabled, every time a key is pressed the backlight comes on for 15 seconds. This dramatically reduces the battery life. If the backlight was on continuously the battery life would reduce down to 8hrs, and if the 4-20mA was used constantly at 20mA, this would reduce the battery life by 20%. The display in flow mode continually shows the battery level as a percentage. When this indication reads approximately 20%, it will display a warning message, at which point there is only 30 minutes of use left. The battery can be charged while the instrument is in use or overnight while the instrument is switched off. The instrument can be partially charged and then used.

2.5 Keypad

Programming is via the tactile membrane keypad with rim embossed keys. The keypad is rated at IP65.

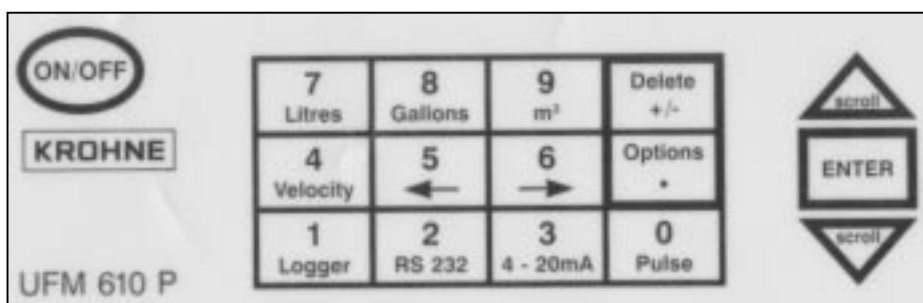

Figure 6

By selecting keys **4**, **7**, **8** and **9** it is possible to change the velocity and volumetric flow reading. Press the key more than once to change the display.

Press **4** > m/s, Press **4** > f/s
Press **7** > l/s, Press **7** > l/min
Press **8** > g/min, press **8** > kg/hr,
press **8** > usg/min, press **8** > uskg/min
Press **9** > m³/hr, press **9** > m³/min,
press **9** > m³/sec

There are some facilities that require you to move the cursor on the display left and right as well as up and down. This is done with keys **5** (left) and **6** (right).

The 4-20mA, Pulse, RS232 and logger keys can only be activated from flow mode (see page 33 - Keypad Options) but the RS232 and data logger are also on the MAIN MENU.

2.6 Temperature indication/range

The transducers work over two temperature ranges. The standard temperature range is from -20 °C to +100 °C and high temperature is from -20 °C to +200 °C. The application temperature is displayed when in flow mode only if the prop/temp sensor cable is connected. If the instrument is displaying the temperature produced from the sensor in the transducer, then this figure will vary if the temperature of the application varies, which could serve as an indication of change in the process. The instrument can only compensate for a temperature change of ±10°C when reading flow.

2.7 Transducers

The UFM 610 P uses three different transducer types to measure flow which we call “A”, “B” and “C”. These are selected by the instrument depending on the data entered, the pipe size and flow velocity. There are default settings that are programmed into the instrument and most of the time these will not need to be changed, although it is possible to use different transducer sets on different pipes outside their normal operating range. (see 3.4 Select sensor set).

2.7.1 Transducer set "A"

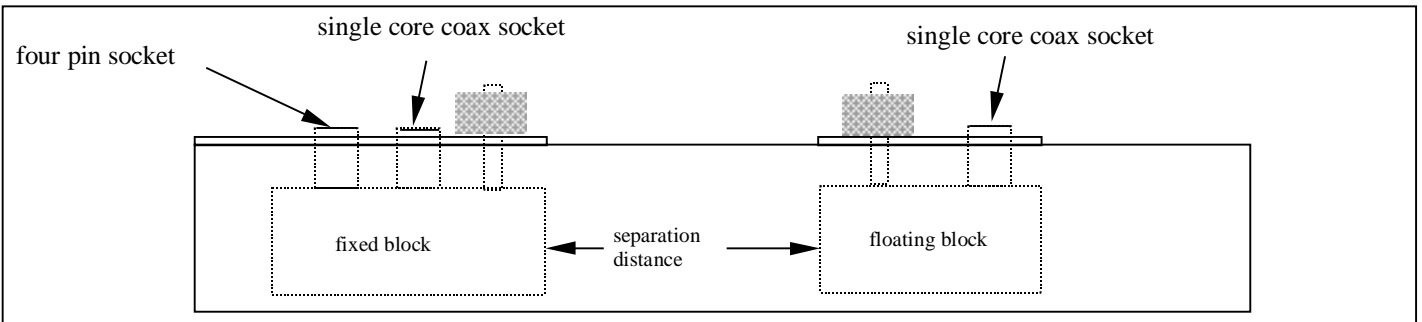
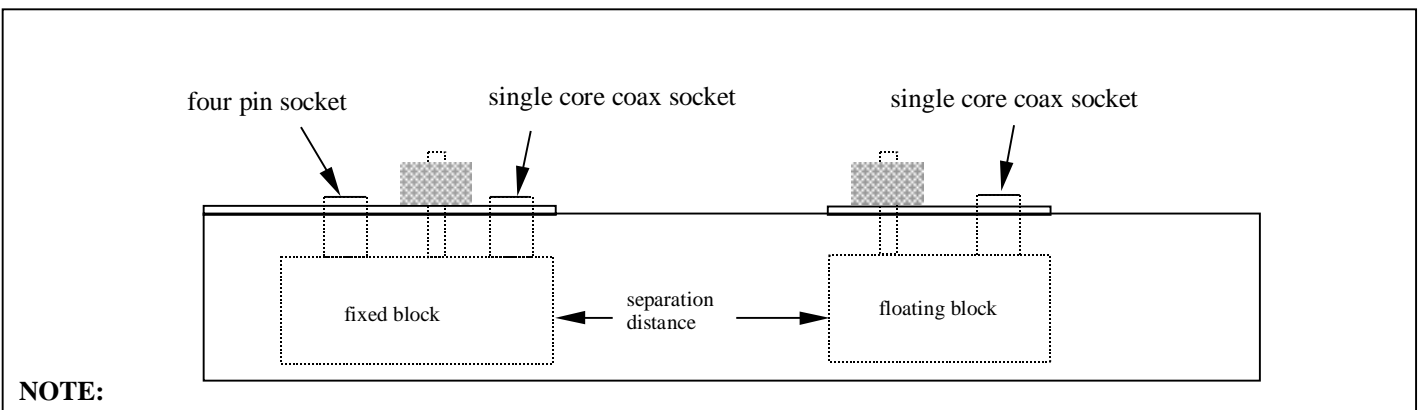

Figure 7

2.7.2 Transducer set "B" and "C"



NOTE:

The sensor blocks must always be placed in the guiderail as shown above. If for any reason they get taken out, it is possible to put them back in the opposite way. This will result in the instrument not working correctly.

Transducer set "A" and transducer set "B" are positioned in the guiderail, to help align the transducer blocks along the pipe axis correctly. Both the "A" and "B" guiderails have two sensor blocks. One of these is fixed, the other is moveable and can slide up & down the scale to enable you to set the separation distance required.

The separation distance is calculated by the instrument when the application information has been entered. The fixed sensor can be identified because it is slightly longer and has two connections as opposed to the floating block only having one connection. Each guiderail can be mounted to the surface of the pipe using the mounting hardware provided, which includes both velcro and webbing straps. Magnetic attachments are available as an option with guiderail "B" and the diagonal guiderail, "D" sensors are supplied with ratchet straps.

2.7.3 Transducer set "A"

These are supplied for pipes 13mm to 89mm inside diameter. They are only supplied with velcro straps, unless the high temperature version has been supplied. Magnets are not available for this transducer set.

2.7.4 Transducer set "B" and "C"

There are two types of transducer block available that both fit into guiderail "B". One pair for standard velocity on pipes 90mm to 1000mm, the second pair "C" are for higher velocity flow in pipes 300mm to 2000mm inside diameter. Magnetic attachments are available to fit onto these guiderails as a standard they are supplied with chains.

2.7.5 Transducer kit "D"

The "D" transducers are for use on pipes 1000 mm to 5000 mm inside diameter. The sensors are supplied with their own guide rails, ratchets and webbing straps. They may also be supplied with chains if required, if webbing straps have been supplied with the standard instrument they also can be used to attach to the "D" guide rail. The "D" sensors are aligned in the same way as other transducers i.e. in Reflex or Diagonal mode and the separation distance is taken from the front edge of the block as shown in figure 12. the transducers are made from a perspex material with an operating range up to +80°C. Please state when ordering "D" sensors whether you were supplied with webbing straps or chains with your original UFM 610 P.

2.8 Separation distance

The separation distance is calculated by the instrument when all the parameters have been entered in and the fixed transducer has been turned down onto the pipe surface. The next stage is to slide the moveable sensor to the separation distance required and screw down onto the pipe surface making sure not to overtighten as it may force the fixed sensor off the pipe wall - finger tight is sufficient! The separation distance is the distance between the front face of each sensor block. See Figures 9, 10, 11, 12 pages 12 & 13, for examples in both reflex and diagonal mode. Connections are made via the LEMO IP65 connectors between the sensor block and the electronics.

2.9 Attaching the transducer

The guiderails are attached to the pipe surface as shown in Figures 9, 10, 11 and 12 using velcro, webbing straps, chains or magnets.

2.9.1 Reflex mounting hardware - Transducer set "A"

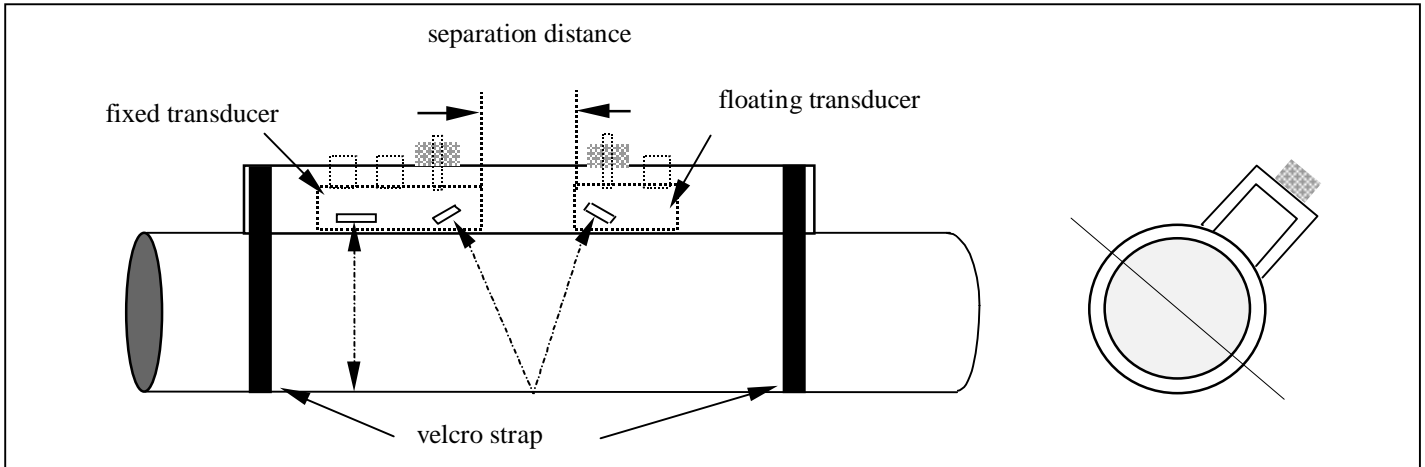

Figure 9

2.9.2 Reflex mounting assembly - Transducer sets "B" and "C"

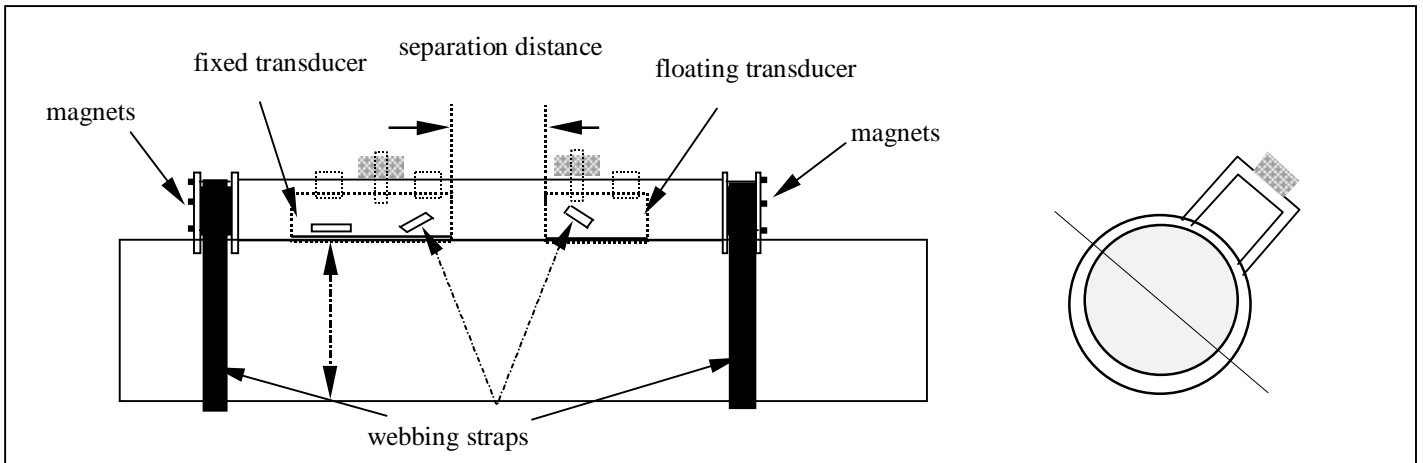

Figure 10

2.9.3 Diagonal beam mounting hardware for transducer sets "B" & "C"

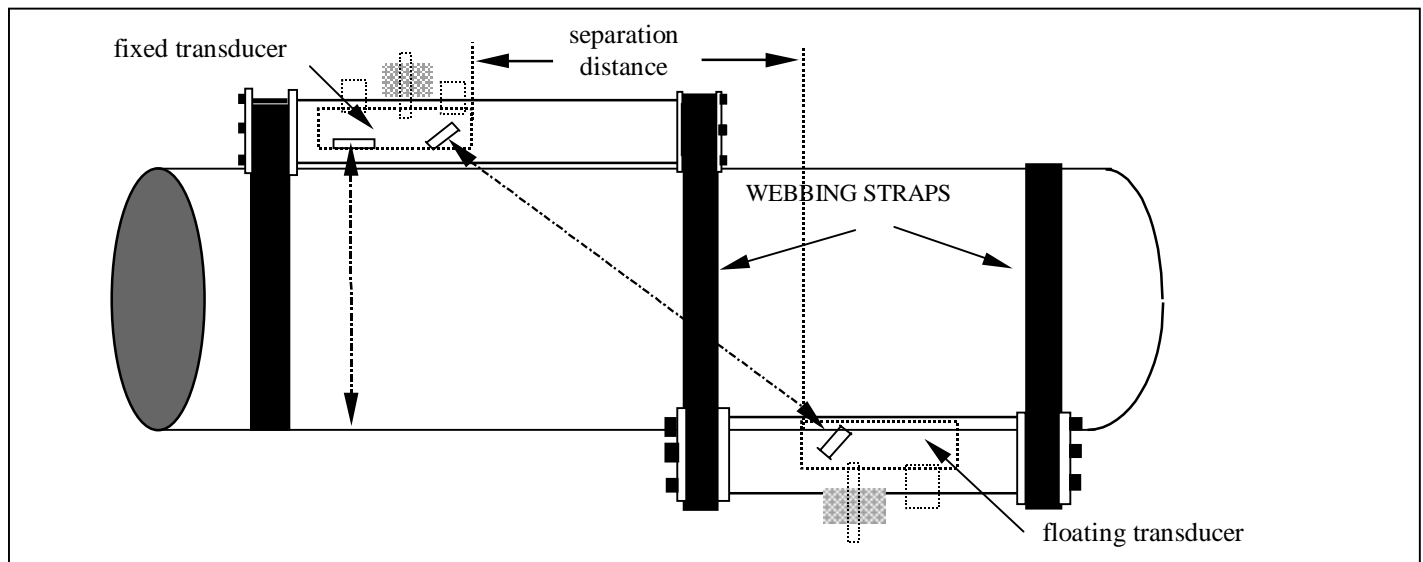
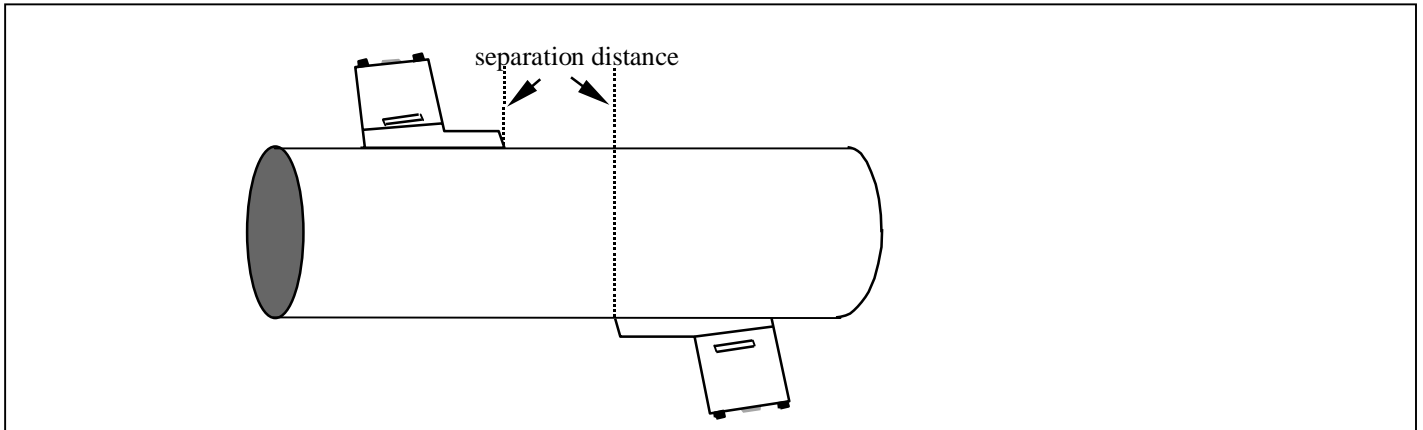

Figure 11

2.9.4 Diagonal beam mounting for transducer set "D"



2.10 Ultrasonic couplant

Figure 12

Ultrasonic couplant must be used on the sensor face to interface with the pipe wall. (See Figures 20, 21 & 22). On applications above 100°C high temperature couplant will be required, and is supplied as standard with high temperature sensors.

2.11 Fluid types

The type of fluids that can be measured with the UFM 610 P are clean liquids or oils etc. that have less than 3% by volume of particulate content. Liquids that are cloudy, like river water, effluent etc. can be measured and also liquids that are clean, like demineralised water. During the set up procedure the user is asked to select from a list of liquids (See **fluid type** 3.2) which includes water and oils. If the liquid to be measured is not listed it is possible for the instrument to measure the propagation rate automatically, but only when pipes sizes are greater than 40 mm internal diameter (See 6.5). Applications include :- River water, Seawater, Potable water, Demineralised water, Treated effluent, Water/Glycol systems, Hydraulic systems and Diesel oil.

3. PROGRAMMING/MAIN MENU

Switch on...

```
KROHNE

Press 0 for English
Press 1 for French
Press 2 for German
Press 3 for Spanish
Serial 0000 v 2.00
```

3.1 Main menu

Press SCROLL up or down to move cursor to required option, then press ENTER to select.

```
MAIN MENU yy-mm-dd hh:mm:ss
Quick start
View/Edit Site Data
Select sensor set
Data Logger
Set up RS232
Set up UFM 610 P
Read flow
```

3.2 Quick start

Selecting quick start offers the user the easiest option to achieve flow measurement. If the instrument has been used previously, it stores the last **QUICK START** application data, which can be accessed via the **MAIN MENU** option **Read flow**. This allows the user to measure the same application without spending time entering new data.

If **QUICK START** is selected, proceed with the following routine. Use the scroll keys to select, then press ENTER.

```
QUICK START yy-mm-dd hh:mm:ss

Select the dimension units:

Millimetres
Inches
```

The instrument now asks for the **Pipe outside diameter?** After entering the outside diameter press ENTER.

```
QUICK START yy-mm-dd hh:mm:ss

Dimension units MILLIMETRES

Pipe outside diameter? 58.0
```

Pipe wall thickness now appears on the display.
After entering the pipe wall thickness, press ENTER.

QUICK START	yy-mm-dd hh:mm:ss
Dimension units	MILLIMETRES
Pipe outside diameter?	58.0
Pipe wall thickness?	4.0

Pipe lining thickness now appears on the display. If the pipe you are measuring has a lining, you now enter the **Pipe lining thickness**. If nothing is entered the instrument automatically assumes there is no lining, press ENTER to move on. If the application has a pipe lining, enter the required thickness in the units selected. Press ENTER to continue.

QUICK START	yy-mm-dd hh:mm:ss
Dimension units	MILLIMETRES
Pipe outside diameter?	58.0
Pipe wall thickness?	4.0
Pipe lining thickness?	0.0

The instrument now displays **Select pipe wall material**. By using the scroll keys it is possible to scroll up or down the options available. Select the required material and press ENTER.

QUICK START	yy-mm-dd hh:mm:ss
Select pipe wall material:	
Mild Steel	
S' less Steel 316	
S' less Steel 303	
Plastic	
Cast Iron	
Ductile Iron	
Copper	
Brass	
Concrete	
Glass	
Other (m/s)	

The following will only be displayed at this stage if a lining thickness had been entered previously.
Use the scroll keys to select the required material then press ENTER. If **Other** is selected, enter the propagation rate of the lining in metres/sec. Contact KROHNE if this is not known.

QUICK START	yy-mm-dd hh:mm:ss
Select pipe lining material:	
Steel	
Rubber	
Glass	
Epoxy	
Concrete	
Other (m/s)	

Select fluid type now appears on the display.
Use the scroll keys to select the application liquid and press ENTER. If **Measure** is selected, the instrument automatically measures the propagation rate of the liquid, but only when the pipe size is greater than 40 mm internal diameter. If the liquid is not listed select **Other** and enter a propagation rate in metres/second. This may be found in the back of the manual under **Liquid Sound Speeds**.

QUICK START	yy-mm-dd hh:mm:ss
Select fluid type:	
Water	
Glycol/water 50/50	
Lubricating oil	
Diesel oil	
Freon	
Measure	
Other (m/sec)	

3.2.1 Attach sensors

The instrument will now provide the user with details on the type of sensor to be attached to the pipe and the mode of operation. It will also give the approximate maximum flow that can be achieved with the sensors that have been selected.

It is possible to change the flow units at this stage to display the maximum volumetric flow. Use the keypad to select a flow unit. Now connect the RED, BLUE and BLACK sensor cables, between the guide rail and the electronics.

```
ATTACH SENSORS      yy-mm-dd hh:mm:ss

  Attach sensor set A in REFLEX mode
                    (RED connector upstream)
  Approx. max. flow:      7.20 m/s

  press ENTER to continue
  or SCROLL to select another sensor
```

If the instrument cannot find a temperature signal because the black sensor cable is not connected, it asks the user to try again. Pressing ENTER will make the instrument try again or scroll will prompt the user to enter a value. When a value is entered press ENTER.

```
ATTACH SENSORS      yy-mm-dd hh:mm:ss

  No signal from temp sensor

  Press ENTER to try again or
  SCROLL to enter a value
```

Pressing ENTER at this point will give the user the separation distance or ask for a temperature to be entered.

```
ATTACH SENSORS      yy-mm-dd hh:mm:ss

  FLUID TEMPERATURE (°C)      20.0
  Set sensor separation to    34

  Press ENTER to continue
```

NOTE:

**The fluid temperature will only be displayed when entered manually.
The separation distance is displayed in mm.**

READ FLOW now appears on the display.

READ FLOW	yy-mm-dd hh:mm:ss
(ERROR MESSAGES APPEAR HERE)	
Battery	100%
Signal	83%
Temp	20°C
+ Total	1564 l
- Total	0 l
100.0 l/m	

The display will now read flow and will default to m/s, unless other units were selected when the instrument displayed the sensor mode and type. To select other units press the appropriate key and pressing more than once scrolls through other options. When reading volumetric flow the instrument will display a positive and negative total flow. These totals can be reset by selecting **OPTIONS** from the keypad. (See 4.6).

When in flow mode the instrument will continually display the battery and signal levels. Signal levels should be above 30%. If there is an error in the site data or the application the instrument will display an Error or warning message (See 5.3.2) which will appear above the flow reading.

To stop reading flow press ENTER **ONCE** in flow mode and the display will read the following.

Pressing ENTER a second time will stop all logging/outputs and return the instrument to **MAIN MENU**. Pressing the scroll key returns the instrument to **READ FLOW**.

EXIT FLOW	yy-mm-dd hh:mm:ss
This will stop all logging and outputs	
Press ENTER to EXIT or SCROLL to return to READ FLOW	

3.3 View/edit site data

The **VIEW/EDIT SITE DATA** mode can be accessed from the main menu and allows the user to enter application details of up to 20 different sites. A useful facility if a number of sites are being monitored on a regular basis and data needs to be stored at a later date and it may not be possible to get to a PC.

When scrolling up/down the menu press ENTER to select at each command.

VIEW/EDIT SITE DATA	yy-mm-dd hh:mm:ss
List sites	
Site number	0
Site name	QUICK START
Dimension units	MILLIMETRES
Pipe outside diameter	58.0
Pipe wall thickness	4.0
Pipe lining thickness	0.0
Pipe wall material	MILD STEEL
Lining material	-----
Fluid type	WATER
Read flow	
Exit	

NOTE:

Site Zero is always the QUICK START data, the name cannot be changed.

Changing the data in any site is automatically saved when leaving this menu. Data will have to be re-entered if the input is incorrect.

3.3.1 List sites

Selecting **LIST SITES** allows the user to view the names of up to 20 sites, numbers 1-10 appear first. Pressing ENTER at this point will display sites from 11- 20. Press again and the display returns to the **VIEW/EDIT SITE DATA** menu.

LIST SITES	yy-mm-dd hh:mm:ss
1 site not named	6 site not named
2 site not named	7 site not named
3 site not named	8 site not named
4 site not named	9 site not named
5 site not named	10 site not named

Press ENTER to continue

3.3.2 Site number

Site number allows the user to enter the number of the site data that you wish to be displayed. If the site has not been used then no data would have been stored. It is possible to add application data at this point.

3.3.3 Site name

Site name allows the user to edit the site name. Use the scroll keys to move the cursor to the letter/figure required and press ENTER to select. Press 0 to return the instrument back to **VIEW/EDIT SITE DATA**. The new site name will appear on the display.

VIEW/EDIT SITE DATA	yy-mm-dd hh:mm:ss
Use SCROLL to choose, ENTER to select, for space, DELETE to clear, 0 to end	
a bcdefghijklmnopqrstuvwxyz0123456789	
>.....<	

3.3.4 Dimension units

Dimension units allows the user to switch between millimetres and inches. By doing this all the data in that particular site number will also be converted. **Pipe wall/lining thickness** and **Pipe wall/lining material** can now be changed as required. Lining material is ignored if a lining thickness was not entered. A selection of pipe wall/lining materials will be displayed when these options are selected.

3.3.5 Fluid type

Fluid type allows the user to scroll through a selection of fluid types. Fluids not listed can be automatically measured by selecting the **Measure** option in the **QUICK START**, but only when the pipe internal diameter is greater than 40 mm, **Select fluid type**, menu. When **Other** is selected the user must enter the propagation rate in m/s, this can be supplied by KROHNE or found in the back of the manual under Liquid Sound Speeds on request.

3.3.6 Read flow

Selecting **Read flow** now informs the user which sensor set should be used, in which mode and the approximate maximum flow rate in the units selected. This can be changed by pressing the appropriate key.

```
ATTACH SENSORS      yy-mm-dd hh:mm:ss
                    Attach sensor set A in REFLEX mode
                    Approx. max. flow:      7.22 m/s
                    press ENTER to continue
                    or SCROLL to select another sensor
```

The instrument will now give a separation distance if the Prop/Temp cable is connected or ask for the temperature to be entered. Once this has been entered press ENTER to move on and read flow.

3.4 Select sensorset

When application information is programmed into the instrument it automatically selects the sensor set and the mode of operation, i.e. REFLEX or DIAGONAL. It is possible however to use different sensors in different modes.

```
SELECT SENSOR SET  yy-mm-dd hh:mm:ss
Sensor set      A
Sensor mode        REFLEX
Read flow
Exit and select default sensor
```

This option is available for two main reasons. Firstly, if from the data that has been entered the instruction comes back that the sensors should be mounted in DIAGONAL MODE, it may be that this is not possible in the case of a partially buried pipe. Under these circumstances, provided that the velocity is low enough it may be possible to select another sensor set that will allow the sensors to work in REFLEX mode (See figures 9 & 10). It may be that the transducers do not need to be changed, but by changing the Sensor mode from Diagonal to Reflex it may now be possible to measure the flow on this particular application. If there is a need to change transducers, always select the sensor set that will measure the range of larger pipes and higher flows.

The second reason for this option is that in the case of applications where the signal is not strong enough to get through a corroded pipe for example, the instrument may have selected sensors to be used in REFLEX mode. If this is the case then the user can select diagonal mode instead, which would have the effect of increasing the signal strength and maximum flow rate.

When the instrument selects REFLEX it is possible to change the sensor mode to DIAGONAL, by selecting **Sensor mode** then **Diagonal** in the **Select sensor set** menu. This would have the effect of doubling the signal strength and the default flow range.

3.4.1 Sensor set

Selecting **Sensor set** gives the choice of using different sensors. The choices that are listed are A,B,C and D.

TRANSDUCERS	SENSOR FREQUENCY	VELOCITY RANGE
Set "A" 13mm pipe	2 MHz sensors	0.2 m/sec to 7 m/sec
Set "A" 89mm pipe	2 MHz sensors	0.03 m/sec to 3,75 m/sec
Set "B" 90mm pipe	1 MHz sensors	0.06 m/sec to 6,75 m/sec
Set "B" 1000mm pipe	1 MHz sensors	0.02 m/sec to 1.25 m/sec
Set "C" 300mm pipe	1 MHz high velocity	0.06 m/sec to 6 m/sec
Set "C" 2000mm pipe	1 MHz high velocity	0.02 m/sec to 1,7 m/sec
Set "D" 1000mm pipe	0.5 MHz sensors	0.04 m/sec to 3,45 m/sec
Set "D" 5000mm pipe	0.5 MHz sensors	0.014 m/sec to 1,36 m/sec

There are limits to the range of flow that any transducer set can measure (See 6.8 - Flow Range) and if a sensor set has been selected that is out of the instruments sensor range and capabilities, an error message will be displayed.

EXAMPLE

The display may also read, Sensor mode is invalid for this pipe size.

SITE SENSOR ERROR yy-mm-dd hh:mm:ss

Cannot READ FLOW because
pipe is too large/small for sensor set

Press ENTER to continue

3.4.2 Sensor mode

Selecting **Sensor mode** allows the user to choose which method of clamping the sensors to the pipe is required. The default would have been displayed on the previous screen, but **Sensor mode** can be selected to give the user a choice between Reflex and Diagonal. **Double reflex** can only be used on pipes between 20mm and 30mm.

Triple reflex mode can only be used on pipes less than 20mm. Both of these modes of operation are designed to increase the low flow performance of the instrument. Triple and double reflex are selectable in the software but the set up of the transducers will not be any different to normal reflex mode.

3.4.3 Read flow

Moving the cursor to **Read flow** and pressing ENTER, takes the instrument to the display which informs the user of the sensor set that has been selected, in which mode of operation the sensors have to be attached to the pipe and also the maximum flow capable.

If at this point the maximum flow is too low or high in relation to the application, then another sensor set may be selected by pressing scroll and getting back to the main menu.

3.4.4 Exit and select default sensor

Selecting EXIT will take you back to **MAIN MENU**.

3.5 Data logger (see also **KEYPAD OPTIONS-data logger**)

The data logger can be accessed when in flow mode via the keypad or from the main menu. Accessing the logger via the keypad when in flow mode allows the user to set up the logger. e.g. start time, interval time etc. and view the stored data.

Accessing the logger from the main menu only allows the user to view the data that has already been stored. If there is no data stored in the memory the instrument will display the following.

```
MAIN MENU                yy-mm-dd hh:mm:ss
                        No logged data in memory
                        Press ENTER to continue
```

Data is stored in 224 blocks, each block having 240 data points. Every time the logger is started a new block of memory is used. If one application was to take up all the memory it would use all 224 blocks.

Use scroll to move the cursor to the required option then press ENTER to select.

```
MAIN MENU-DATA LOGGER yy-mm-dd hh:mm:ss
Units                l/s
List block names
Next block to view      7
View log as text
View log as graph
Graph Y-axis max.      7.3
Download log
Clear log
Memory free            53760
Exit
```

3.5.1 Units

Selecting units only informs the user of the flow units that the logger is measuring.

3.5.2 List block names /list block to view

The blocks of data will now appear in groups of 10. Press the SCROLL key to find the block of data required. When the block number is found, press enter to return to the DATA LOGGER menu. Scroll down to **Next block to view** and enter the number selected from the **List block names** option. When viewing data, the instrument will go directly to the block of data selected, either when viewing as text or graph.

LIST BLOCKS	yy-mm-dd hh:mm:ss
1.Pump room	6.xxxxxxxxxxxxxxx
2.Boiler House	7.xxxxxxxxxxxxxxx
3.xxxxxxxxxxxxxxx	8.xxxxxxxxxxxxxxx
4.xxxxxxxxxxxxxxx	9.xxxxxxxxxxxxxxx
5.xxxxxxxxxxxxxxx	10.xxxxxxxxxxxxxxx

SCROLL to continue, ENTER to exit

3.5.3 View log as text

Text can be viewed in blocks, each having 240 data points. The display will list the text that has been logged from 0-240. It is possible to scroll up and down the list using the scroll keys or by using keys **5** and **6**, when the data will move in blocks of 60. Each point is equivalent to the time the user has programmed into the instrument. i.e. if the instrument has been programmed to read every 10 minutes, every data point will be equivalent to whatever the reading was at that time.

The message **Error occurred** appears on the display when there is a signal loss or unstable flow conditions while logging. The instrument cannot record what the error was under these conditions.

MAIN MENU-LOG TEXT	yy-mm-dd hh:mm:ss
Block: 1/ 1	(log name)
0	yy-mm-dd hh:mm:ss 100 l/m
1	yy-mm-dd hh:mm:ss 100 l/m
2	yy-mm-dd hh:mm:ss Error occurred
3	yy-mm-dd hh:mm:ss Error occurred

3.5.4 View log as graph

The logged data can also be viewed as a graph, in blocks or sections of data points. It is possible to view the flow rate and time at any point on the graph, by moving the cursor along to that particular point. This can be done by pressing the scroll keys in the direction you want the cursor to move. Keep the scroll key pressed for the cursor to move automatically. The flow rate and time that appears in the bottom left hand corner of the display, relates directly to the position of the cursor.

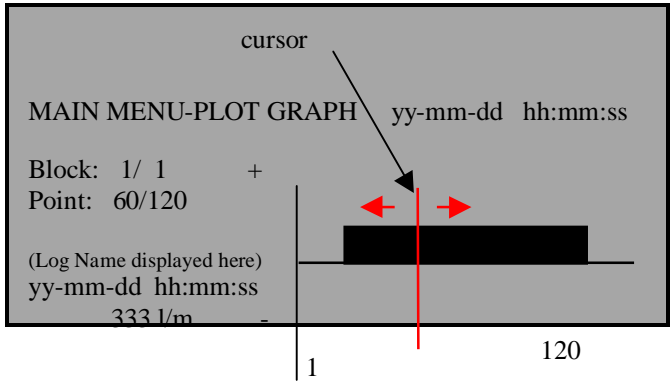

3.5.5 Graph as axis maximum

The Y axis defaults to the maximum flow achievable with the sensors that have been selected from the data entered, but can be adjusted to increase the resolution of the graph.

This example shows the flow is constantly at maximum flow rate.

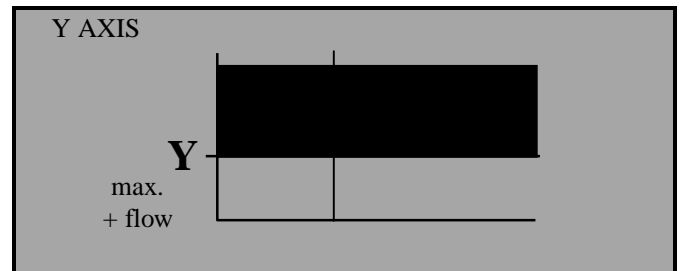

The following example shows the same flow rate but with the Y-axis value having been doubled.

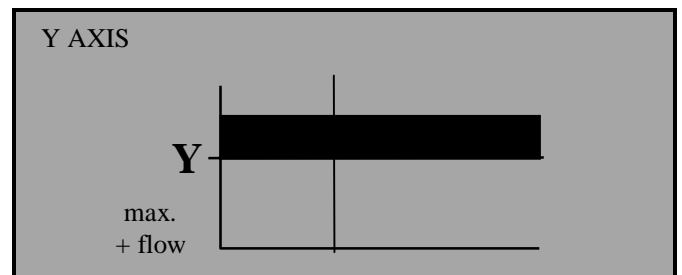

3.5.6 Download log

If the data is being downloaded to Windows 95 and Windows 3.1, then this has to be set up before the user selects the range of data to download, then go to the logger menu, move cursor to **Download log** and press ENTER.

If only certain blocks need to be downloaded, then this can be achieved by using the scroll keys.

Scroll down to **First block to Download**, press ENTER then select the block you wish to start from. The same procedure should be followed to select the **Last block to download**. When both of these are selected scroll back up to **Download range to RS232** and press ENTER.

3.5.7 Example

It may be that data has been recorded in blocks 1 to 7 but only information in blocks 1 to 3 are required. This is done by selecting 1 as the **first block to download** and 3 as the **last block to download**, scrolling back up to **download range to RS232** and pressing ENTER, will download the data required. Should a block number which, is out of range be entered, an error message **Block number out of range** will appear.

```
DOWNLOAD LOG                yy-mm-dd hh:mm:ss
Download range to RS232
First block to Download      1
Last block to Download      3
Exit
```

Press ENTER the instrument will display.

```
DOWNLOAD LOG                yy-mm-dd hh:mm:ss

      Currently Downloading
Block 3/ 3                   Point 113/240

Printer status: UNKNOWN/READY

      Press ENTER to cancel
```

Printer status: UNKNOWN means that when setting up the RS232, **Handshaking = None** was selected.

Printer status: Ready means the unit is ready to send data.

Printer status: Busy means the unit is off line or the buffer is full to the printer.

The UFM 610 P will continue to download the data until complete. Press SCROLL to exit and return to the **MAIN MENU**. Press ENTER on the UFM 610 P to stop downloading at any time.

3.5.8 Clear log

By selecting clear log and pressing ENTER, the display will read the following.

```
CLEAR LOG                   yy-mm-dd hh:mm:ss

      Press ENTER to clear the log
      Or press SCROLL to return
```

Pressing ENTER will display the following.

```
MAIN MENU                   yy-mm-dd hh:mm:ss
      No logged data in memory

      Press ENTER to continue
```

If **Clear log** is selected while the data logger is recording the following message will appear.

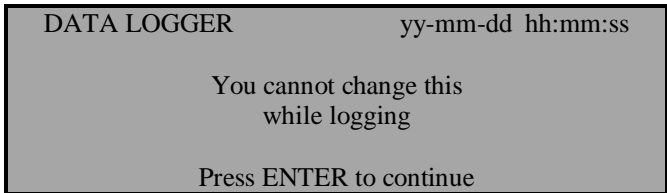

3.5.9 Memory free

Gives the number of free data points for a maximum of 53760 (224 x 240).

3.6 Download data to Windows '95

KROHNE suggests when downloading to a P.C. that **Handshaking = None** is selected (See 3.8 - **SET UP RS232**) when setting up the RS232 for maximum data transfer speed. Check there is data to download by selecting view text in the **DATA LOGGER** menu.

Connect the RS232 cable between the UFM 610 P and COM1 or COM2 on your PC. When in Windows 95 select, **Start >Programs >Accessories >Hyper Terminal**, then select the **Hypertrm** icon.

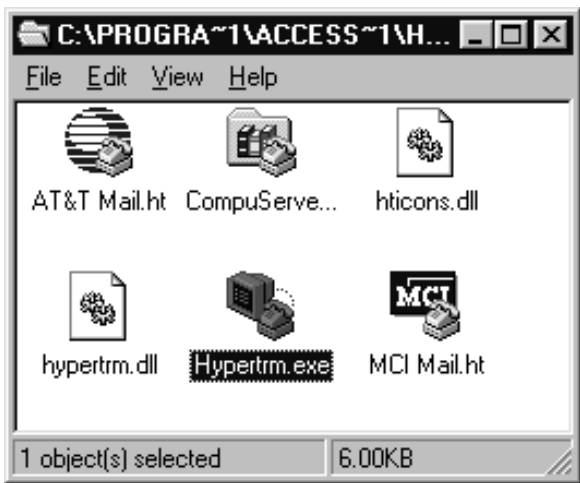

The heading **Connection Description** will appear after **Hypertrm** has been selected. Enter the name of your choice. Select OK when complete.

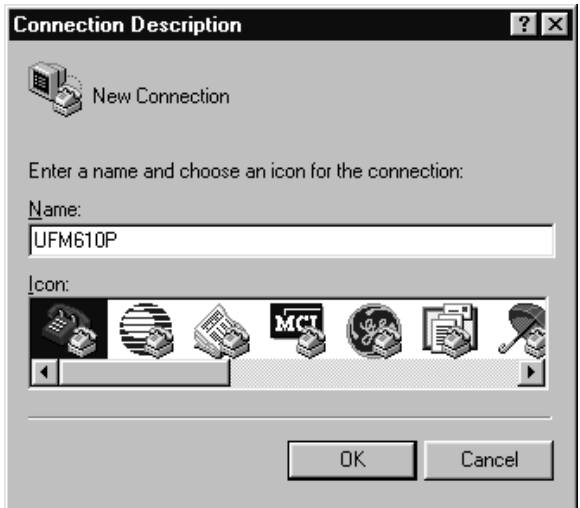

The heading **Phone Number** will appear.
 Select **Connect using:**, then **Direct to Com 2**. When this has been selected the heading **Com 2 Properties** will appear, select OK.

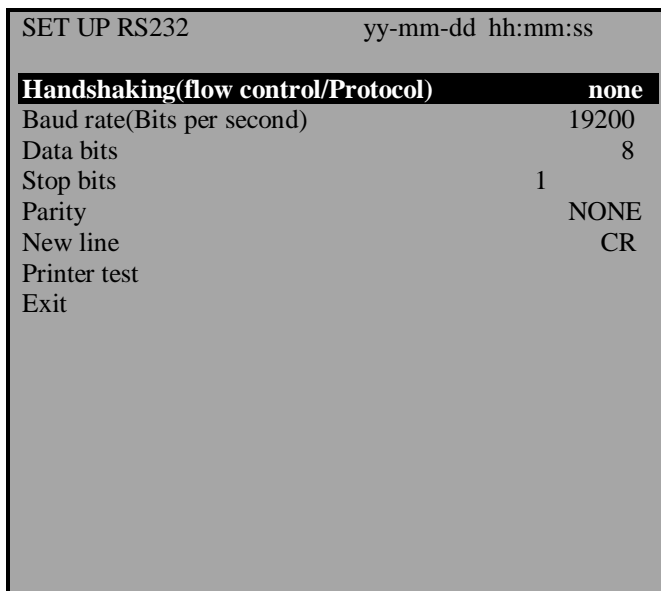

The UFM 610 P can now be configured to the PC. Select **Set-up RS232** on the **MAIN MENU** of the UFM 610 P and press ENTER. Change the settings on the computer to match those on the UFM 610 P then exit the menu.

3.6.1 Downloading data to a spreadsheet in Windows '95

Before downloading data onto a spreadsheet and **Download range to RS232** is selected on the UFM 610 P, the data has to be stored to a file. Data cannot be entered onto a spreadsheet after **Download to RS232** has been selected.

Select **Transfer** then **Capture Text** from the **Hyper Terminal** Window. The following will be displayed.



The data can be saved in any file or directory as a TEXT file. CAPTURE.TXT is a default name that can be changed. Make sure a new file name is given every time data is downloaded, otherwise data is just added to the file of the same name. Press start. When entering a file name make sure **.TXT** is entered directly after the name given. Once the data is in the file you can leave the Hyper Terminal without having to save the data.

Now go to Excel and find the file name and enter it on a spreadsheet. The following will be displayed.

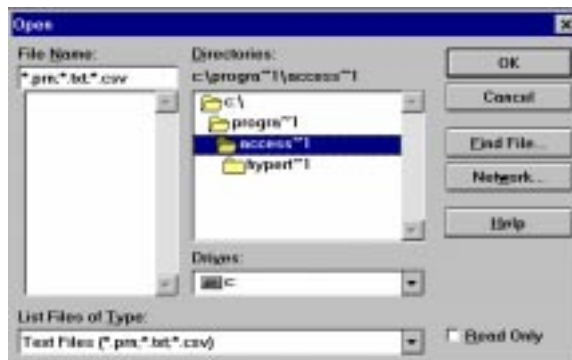

The following will be displayed, allowing the data to be set in a format for Excel.

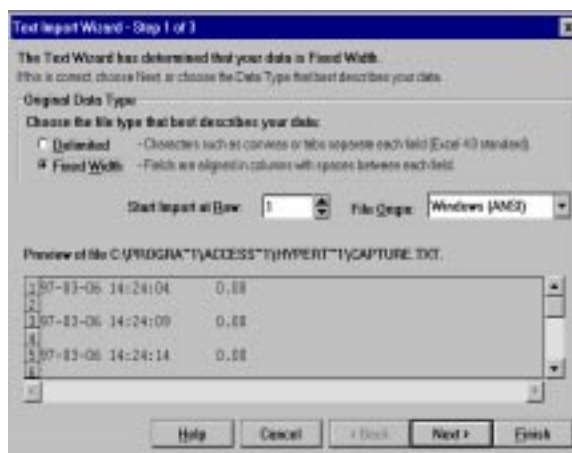

Complete the following 3 Steps in Text import wizard, then select **Printer test** on the UFM 610 P. The following will be displayed.



On the UFM 610 P now select **Main menu**, ENTER > **Data logger** ENTER > **Download log** ENTER. Select a range to download as described on 3.5.7 and press ENTER to download the data.

3.7 Download data to Windows 3.1

Before downloading data onto a spreadsheet and **Download range to RS232** is selected on the UFM 610 P, the data has to be stored to a file. Data cannot be entered onto a spreadsheet unless it has been stored to a file. KROHNE suggests when downloading to a P.C. **Handshaking = None** is selected (See 3.8 - Set Up RS232) when setting up the RS232.

Select **Program Manager** then **Accessories**.



Now select **Settings** and **Communications** from the **Terminal Window**.



The following will be displayed.

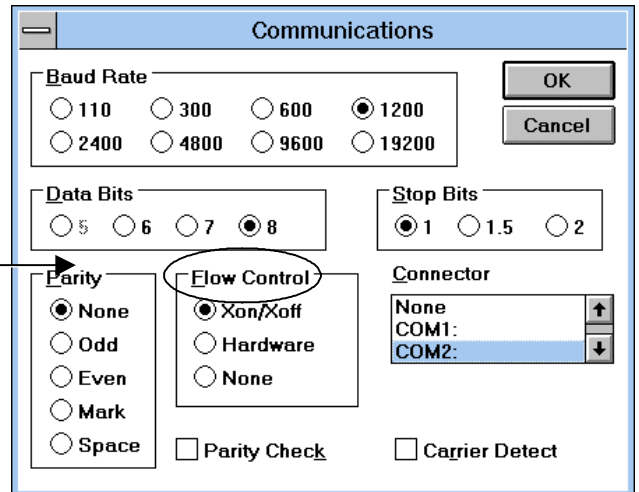

also known as Handshaking or Protocol

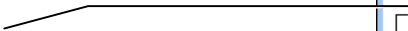

Check now that the above settings are the same as the settings on the UFM 610 P. This can be done from **Read flow** mode using the **RS232** key or from the **MAIN MENU** and **Set up RS232**. If they are not set up correctly an error message will occur in Windows.

3.7.1 Downloading data to a spreadsheet in Windows 3.1

Select **Transfer** from the Terminal Window then **Receive text file**.

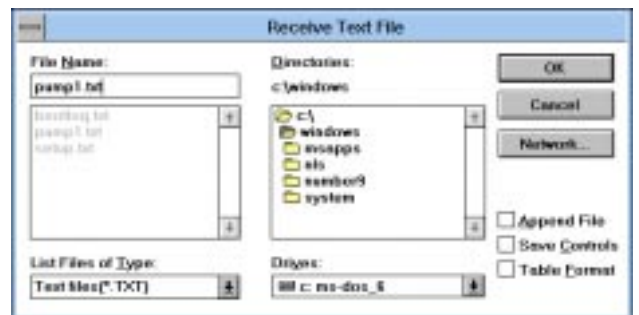

Select a name making sure **.txt** is entered immediately after it and select OK. Make a note of the file name for when you go into the spreadsheet. Select a range to download on the UFM 610 P as described on 3.5.6 and press ENTER to download the data.

Pressing **Download Range to RS232** on the UFM 610 P will now display the following in the Terminal window. Press STOP when complete and escape.

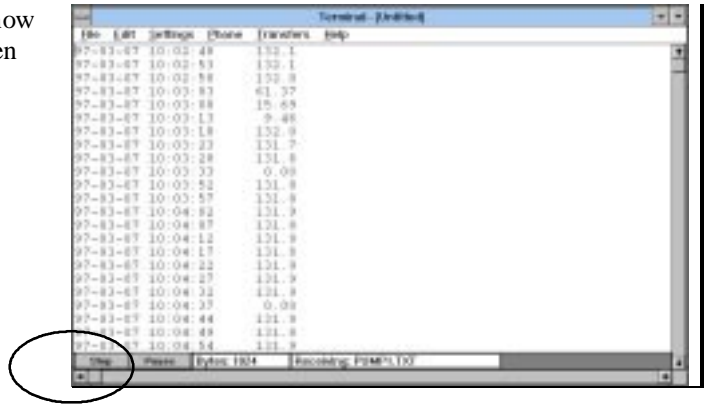

At this point you can go into the spreadsheet to find the file under a text format.

3.7.2 Example from Excel

By selecting OK at this point it is possible to follow the instructions in the Excel handbook.

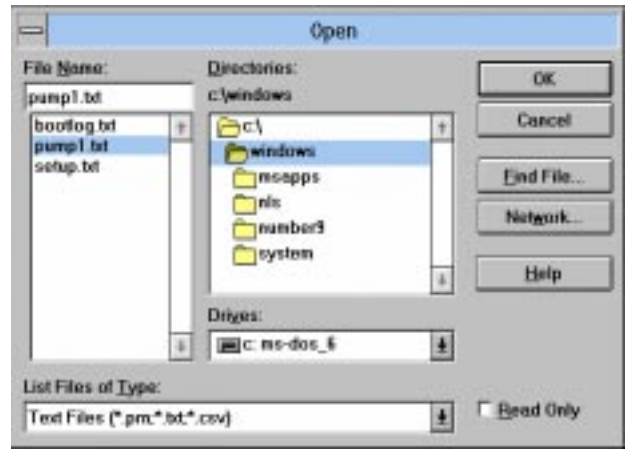

3.8 Main menu set up RS232

The RS232 must be configured to work with exactly the same parameters as the printer or computer that you connect it to. All options on this menu are stored when the instrument is switched off.

Selecting **HANDSHAKING** (also known as flow control or protocol) shows the following display.

Select using the scroll keys then press ENTER to confirm.

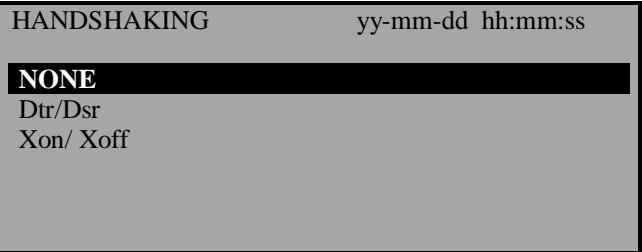

Select using the scroll key then press ENTER to confirm.

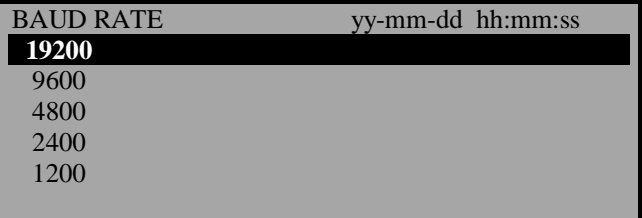

For **Data bits**, **Stop bits**, **Parity** and **New line**, scroll down these options in the **SET UP RS232** and press ENTER to bring up selection. Scroll down the options and press ENTER to select.

Printer test confirms the settings which will be displayed or printed and that there is a connection to the UFM 610 P.

Exit from RS232 returns user to **MAIN MENU**.



3.9 Set up UFM 610 P

3.9.1 Set date & time

When the cursor bar is on **Set date and time** press ENTER, the display will show.

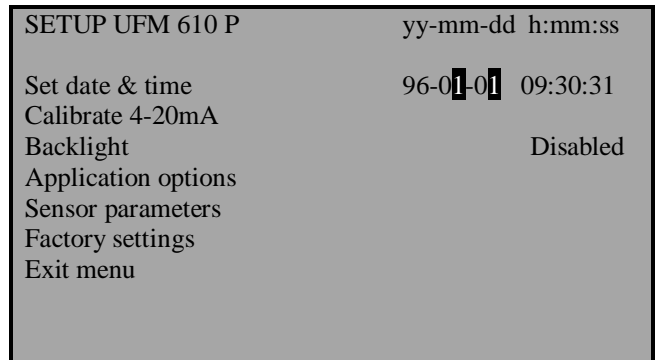

A cursor will be positioned on the month and start flashing. By using the scroll keys you can select the month and by taking the month forward or back past month 12 every time, increases or decreases the year. When the month and year have been selected press ENTER and follow the same procedure for the day. The same procedure is used in setting the time. When everything is set press ENTER and the instrument returns to the **SETUP UFM 610 P** menu.

Calibrate 4-20mA (Note: A meter is required to measure the output.)

The 4-20mA output is calibrated before it leaves the factory, but this option allows the user to adjust it if necessary to match a specific display. The DAC value is a number between 0 and 40,000 which is a number internal to the UFM 610 P that will change when calibrating the 4-20mA.

The first stage is to adjust the output current to 4mA. When connected to any device that accepts 4-20mA, it may require adjustment to exactly 4mA or 20mA and this is possible by using the scroll keys or keys 5 and 6. The scroll keys move the DAC value in larger steps of 25 and keys 5 & 6 move the value one at a time.

The DAC value should be approximately 8000 for 4mA and 40000 for 20mA. By watching the actual current value displayed on the meter, it is possible to scroll up and down or use keys 5 and 6 to calibrate the 4-20mA to the exact value.

When the 4mA is adjusted press ENTER. If the 4-20mA is **not** connected then the instrument will still display the DAC number but display **Error** instead of **OK**.

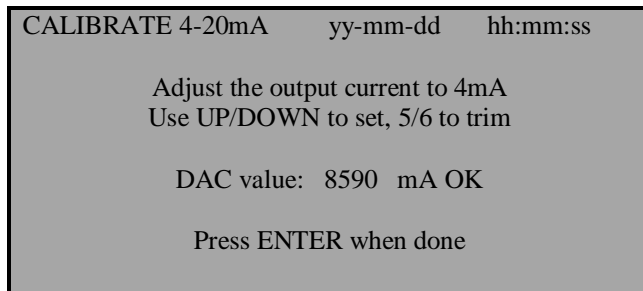

Now adjust the 20mA, press ENTER when complete and the display will return to the **SETUP UFM 610 P** menu.

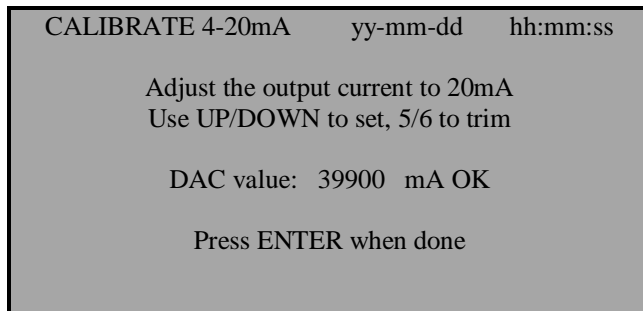

If the load is not connected or too high ERROR will be displayed next to mA, as shown below.

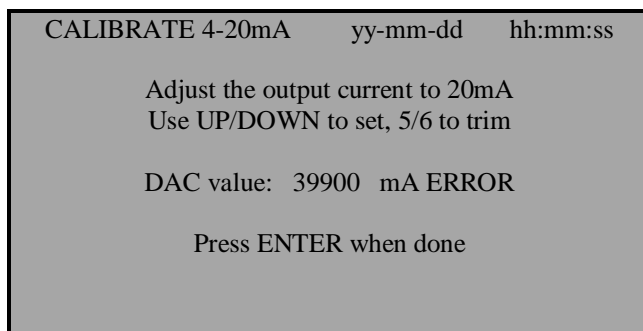

3.9.2 Backlight

Use the scroll key to select backlight and press ENTER.

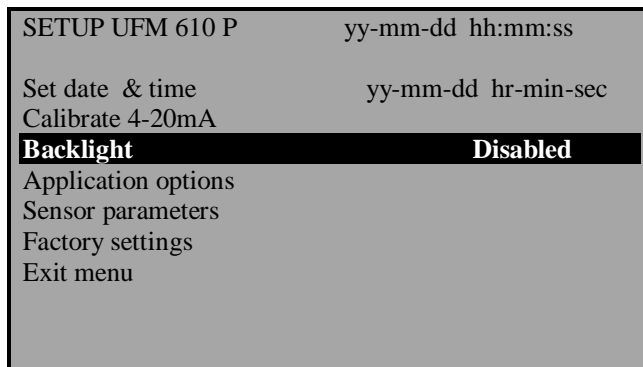

This allows the user to enable or disable the backlight. Use the scroll key to select and press ENTER.

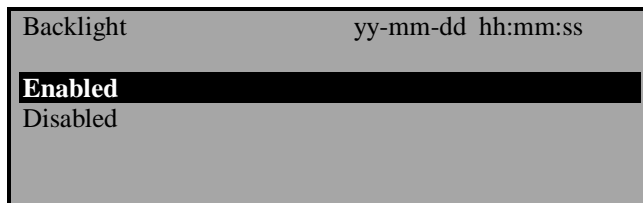

3.9.3 Applications options

Use the scroll key to select Application Options and press ENTER.

```
SETUP UFM 610 P      yy-mm-dd hh:mm:ss
Set date & time      yy-mm-dd hr-min-sec
Calibrate 4-20mA
Backlight           Disabled
Application options
Sensor parameters
Factory settings
Exit menu
```

This option is password protected, contact KROHNE for more information. It is a facility that could enhance signals levels on difficult applications, primarily very small or very large pipes.

3.9.4 Sensor parameters

This facility allows KROHNE or the user to program the instrument to accept different sensor sets in the future, if and when they become available. Instructions for this are included for each new sensor.

The instrument is already programmed to use sensor set supplied.

```
SENSOR PARAMETERS   yy-mm-dd hh:mm:ss

WARNING! Sensor should only be edited
following instructions from the factory
Enter password or press ENTER to quit
```

3.9.5 Factory settings

This is not an option for the user but a facility for KROHNE engineers to calibrate each instrument at the factory. Pressing ENTER in this mode takes the user back to the **MAIN MENU**.

3.10 Main menu read flow

When choosing the **Read flow** option from the **MAIN MENU** the instrument reverts directly back to the data that was last entered. Therefore the instrument will have to be reprogrammed if it is to be used on a new application.

```
ATTACH SENSORS      yy-mm-dd hh:mm:ss

Attach sensor set A in REFLEX mode

Approx. max. flow:   7.20 m/s

Press ENTER to continue
or SCROLL to select another sensor
```

Pressing ENTER now will make the instrument search for a temperature signal. If this is not found then the display will read the following.

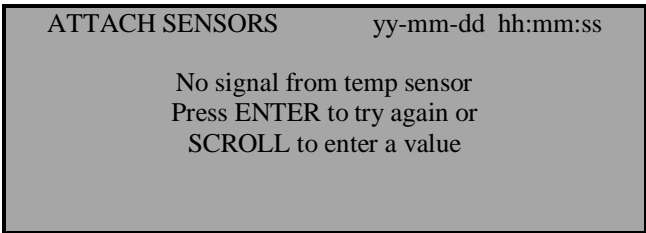

The user can now enter a temperature value between -20°C and +220°C, press ENTER for the separation distance.

The display will now read the following. The temperature will only be shown on this display if entered manually.

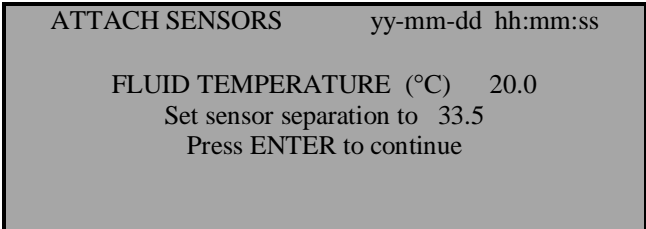

Now set the transducers to the required separation distance. Pressing ENTER will take the instrument into flow mode.

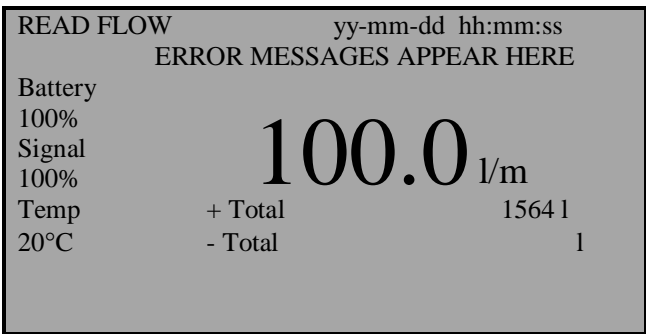

4. KEY PAD OPTIONS

The output options can only be adjusted/operated in flow mode.

4.1 Logger

The data logger can only be set up from flow mode and is accessed via the keypad. Once the logger is recording only some parameters can be changed.

By pressing the logger key the display will read the following

DATA LOGGER	yy-mm-dd	hh:mm:ss
Log name	QUICK START	
Log data to	MEMORY	
Logging interval	5 seconds	
START NOW		
Start time	97-01-22	00:00:00
Stop time	97-01-25	00:00:00
Memory free	53760	
List block names		
Next block to view		
View log as text		
View log as graph		
Units	l/m	
Graph Y-axis max.	3450	
Clear log		
Exit		

4.1.1 Log name

This allows the user to give the data that is going to be logged, a name. The name will be displayed at the start of each block of memory until the instrument has stopped logging.

EDIT LOG NAME	yy-mm-dd	hh:mm:ss
Use SCROLL to choose, ENTER to select, • for SPACE, DELETE to clear, 0 to end		
abcdefghijklmnopqrstuvwxyz0123456789		
>.....<		

4.1.2 Log data to

Selecting this option gives the user the choice of logging to the memory, RS232 or both. Select the option required by using the scroll keys and press ENTER (See also Downloading to Windows 3.6 and 3.7).

4.1.3 Logging interval

This option displays a range of times that allow the user to decide how often the readings need to be logged. The times range from 5 seconds to 1 hour. Use the scroll keys to select then press ENTER.

4.1.4 Start/stop now

This starts and stops the logger immediately. When Start now is displayed press ENTER to start, the display will change to Stop now. When Stop now is displayed press ENTER to stop, the display will change to Start now. This function defaults the logger to 1 hour of logging. If a longer period of logging is required then the **Start/Stop time** will have to be set up.

4.1.5 Start/stop time

This allows the user to program a time for the logger to start and stop logging in advance of going on site. Press ENTER to select and program as per the instructions for setting time and date on 3.9 - Set-up UFM 610 P.

NOTE:

Memory free, List block names, Next block to view, View log as text, View log as graph, Units, Graph Y axis max, Clear log and Exit are the same as described on 3.5 - Main Menu - Data Logger.

4.2 4-20 mA Key

The 4-20mA output can be scaled to whatever the maximum flow rate is. It is also possible to enter a negative figure for the minimum output, which would enable a reverse flow to be monitored. The 4mA would then be the maximum reverse flow (e.g.- 100 lpm) and the 20mA would be maximum positive flow (e.g.100 lpm).

4.2.1 mA Out

This displays what the current output is giving at any particular time.

4 - 20MA	yy-mm-dd hh:mm:ss
mA out	0.00
Output	OFF
Units	m/s
Flow at max. output	3171
Flow at min. output	0.00
Output mA for error	22
Exit	

4.2.2 Output

This option allows the user to select between three different outputs or switching the output off. The display will read as follows.

Scroll down the options to select required output, and press ENTER. The display will then revert back to the **4-20mA** menu and **Flow at max. output**.

OUTPUT	yy-mm-dd hh:mm:ss
OFF	
4 - 20mA	
0 - 20mA	
0 - 16mA	

4.2.3 Units

The flow units can be changed at this stage by selecting them from the keypad. When selected, scroll down to move onto the next option.

4.2.4 Flow at max. output

This sets the output at the top end of the scale so that the maximum flow gives 20mA (or 16mA). The instrument automatically defaults to the maximum flow rate, but by pressing ENTER the user can scale the output to any level required. When selected press ENTER to continue. If the flow was to go over the maximum range set, the instrument will go to a maximum of 24.4 mA and stay there until either the flow reduces or the output is re-scaled. The instrument will also display a warning message that says the **mA out over range** if the output is greater than 20mA or 16mA, whichever has been set.

4.2.5 Flow at min. output

This sets the output at the bottom end of the scale so that the minimum flow gives 4mA or 0mA. The instrument automatically defaults to zero, but the user is able to enter any figure they wish including a minus figure for reverse flow conditions.

4.2.6 Output at mA for error

This gives an error output, which would inform the user of loss of signal. This can be set to any figure between zero and 24mA, but defaults to 22mA.

4.2.7 Exit

4.3 RS232 output key

This is set up in exactly the same way as when the RS232 is set up from the **MAIN MENU** (See 3.8).

4.4 Delete key

If anything is entered in error, press the DELETE key and re-enter the information required.

4.5 Pulse output key

This can only be operated in flow mode. Use the scroll key to move the cursor up or down the display. To change the flow units press the key required. This will also change the flow units when returning to the flow mode. Changing the flow units will also re-scale the litres per pulse.

PULSE OUTPUT	yy-mm-dd hh:mm:ss
Flow units	l/s
OutputOFF	
Max. pulse rate	1 per sec
Litres per pulse	12.76
Exit	

Outputs allows the user to select from the following. Selecting **Off** switches the pulse off and returns to the **PULSE OUTPUT** display. Selecting **Forward total** counts the pulses of the forward flow only. Selecting **Net total** counts the pulses of the sum of the forward total less the reverse total.

OUTPUT	yy-mm-dd hh:mm:ss
Off	
Forward total	
Net total	

4.5.1 Max. pulse rate

This option allows the user to select between fast/slow pulses or large/small pulse width. Select 1 per second for slow pulses and 100 for a fast pulse. The pulse width for 1 per second is 100ms and 5ms for 100 per second.

4.5.2 Litres per pulse

This will change when the flow units are changed above. When the correct flow units are selected this allows the user to scale the pulses to their own requirements or it can be left in the default setting.

4.6 Options key

This can only be used in flow mode. Scroll down the options then press ENTER to select.

OPTIONS	yy-mm-dd hh:mm:ss
Zero cut off (m/s)	0.01
Set zero flow	
Total	RUN
Reset + total	
Reset - total	
Damping (sec)	5
Calibration factor	1.000
Correction factor	1.000
Diagnostics	
Exit	

4.6.1 Zero cut off (m/s)

The instrument has an automatic ZERO CUTOFF that is calculated to 0.05 m/s. The maximum flow is calculated when the instrument is programmed and is displayed when sensor set and mode of operation are displayed (See 3.10 - Read Flow - Attach sensors).

KROHNE cannot guarantee measuring flows below this range because of instabilities in measuring, but it is possible for the user to cancel any cut-off altogether.

This also allows the user to not see or record any flow that they may not want to. For example it may be that the user may not want to measure flows below 50 LPM in a 50mm pipe which is equivalent to 0.42 m/sec, in which case 0.42 m/sec would be entered into the instrument and nothing would be recorded below that level. The maximum **cut off** 1 m/sec.

4.6.2 Set zero flow

On some applications and in some conditions it may be that although there is no flow the instrument may show a small offset due to picking up noise. This is an offset that can be cancelled out and will increase the accuracy of the instrument. By selecting this option and pressing ENTER the display will show the following.

SET ZERO FLOW yy-mm-dd hh:mm:ss

Stop the flow COMPLETELY and then
press ENTER

Press SCROLL to cancel

Pressing ENTER before the flow has stopped will result in an error message which asks **are you sure the flow has stopped**. This occurs when the flow is still above 0.25m/sec. When this option has already been selected, press ENTER to cancel the previous instruction, then it is possible to re-set the Zero balance. This option is not available when error messages E1 and E2 (See 5.2) are being displayed.

4.6.3 Total

This option allows the user to disable both the positive and negative totalisers. As soon as either of these options are selected the totaliser will start or stop functioning. It does not zero the total, this is a separate function described below.

4.6.4 Reset + total/total

The UFM 610 P has forward and reverse totalisers, which can be reset when this option is selected. Use the scroll keys to select then press ENTER to reset. The Total is stored when unit is switched off or battery goes flat, therefore may need to be reset before each use.

4.6.5 Damping (Sec)

This option is used when the flow readings are unstable due to turbulence caused by obstructions or bends etc. Damping or averaging can be used to make the readings more stable. It can be set to up-date the display, anything between 3 and 100 seconds.

4.6.6 Calibration factor

This facility should not need to be used in general use. One reason could be that a guide rail was being used that had not been calibrated with the instrument and had been supplied as a spare. This could cause the instrument to be out of calibration.

If for any reason the instrument goes out of calibration and the readings may be higher or lower than normal then this facility enables the user to correct the reading.

If for example the reading is 4% higher than normal then entering 0.96 will reduce the reading by 4%. If the reading was 4% lower than normal then entering 1.04 would increase the reading by 4%. When the instrument is supplied it will always default to 1.00 and when this is changed it will stay in the memory to whatever it has been changed to, until such time as it needs to be changed again.

4.6.7 Correction factor

This is a facility that can be used when errors occur due to lack of straight pipe or the sensors have been placed too close to a bend, this could give an incorrect reading to what is expected. The user can set this as a % in the same way as the calibration factor, but it will not be stored in the memory.

4.6.8 Diagnostics

4.6.8.1 Calculated μs

This is a value the instrument predicts will be the time in μs that it should take for the transmitted signal to go across a particular pipe size. This value is ascertained from the data entered by the user. i.e. pipe size, material, sensor set etc.

4.6.8.2 Up μs , DN μs

This is the actual transit time measured by the instrument and will be slightly (5-10 μs depending on the pipe size and signal condition) less than the calculated value above.

4.6.8.3 Measurement μs

This is a point in the signal transmitted, where the flow measurement is taken from. It is used to see if the signal is being taken from the burst, at the correct time to get the strongest signal. This is normally used on smaller pipes when the instrument is being used in double or triple bounce where signals can sometimes interfere with each other. This value is normally a few μs below the **Up μs** , **Dn μs** value.

4.6.8.4 Phase up/DN μs

This is only valid if **calculated μs** and **up μs** , **Dn μs** are correct. If the reading is zero then there is no signal, which could mean the pipe is empty, or the liquid is contaminated with particles or air.

4.6.8.5 Phase offset

This value will be between 0 and 15. The exact value is not important and will vary between applications. It should, however, be stable in the short term, but could change with time and temperature over the longer term. As the flow rate reaches its maximum this figure will continuously scroll between 0 and 15 which means it has reached its maximum flow rate capabilities and the display will read unstable flow.

4.6.8.6 Flow m/s

This displays flow velocity in m/sec to 3 decimal places

4.6.8.7 Signal

This is the averaged value of **Signal up/dn** below, and is a value between 800 and 2400 which calculates the signal strength as a percentage (800=0%, 2400=100%).

4.6.8.8 Signal up/DN

This value is in mV the maximum value being limited by the electronics to 2200, but must be greater than 800. There is an option in the SET UP UFM 610 P menu to allow this value to be taken down to 400 in extreme circumstances. This is useful on some applications when the signal levels are poor.

4.6.8.9 Prop μ s

This is the actual time for the signal to traverse the block, pipe wall, fluid and back again. It is proportional to the pipe size and temperature of the liquid.

4.6.8.10 Prop signal

This will be a value between 800 and 2200 as in **Signal up/dn**, above but not the same value.

4.6.8.11 Fluid prop rate

This is the sound speed of the fluid calculated using the data entered by the user and the prop measurement. This value may be subject to errors due to small pipe dimension errors especially on smaller pipes. KROHNE recommend the use of tabulated values (See 6.9).

4.6.8.12 Sensor separation

A reminder for the user and a check for correct use of sensor mode and type.

5. STATUS/ERROR/WARNING MESSAGES

There are three types of message that will appear and they are **Status, Error and Warning**. These messages appear under the time and date on the display when in flow mode.

5.1 Status messages

5.1.1 S1: Initialising

Appears when first entering flow mode to show instrument is starting up.

5.1.2 S2: Logging to memory

This informs the user that the instrument is logging to the internal memory.

5.1.3 S3: Logging to RS232

This informs the user that the instrument is logging to an external device i.e. a printer.

5.2 Error messages

5.2.1 E1: Unstable or high flow

This error message occurs when either the sensors have been positioned too near to an obstruction or bend causing turbulence, or the instrument is being used outside its normal flow range. When the instrument is programmed the user is informed of the maximum flow rate that is possible to measure and if this is exceeded then the high flow message occurs. It may be possible to get round these problems by moving the sensors to a straighter length of pipe or in the case of high flows another set of transducers may be used.

5.2.2 E2: No flow signal

This message appears when the two transducers cannot send or receive signals, which could happen for various reasons. Firstly check that all cables are connected, transducers are on the pipe correctly with grease on the face. These reasons could be when trying to measure a partially empty pipe, aerated liquid or when the particulate content of that liquid is too high. It could also happen if couplant has not been applied to the transducers or the condition of the pipe being measured is poor.

5.3 Warning messages

5.3.1 W1: Check site data

This message occurs when the application information has been entered incorrectly and the wrong sensors have been attached to the wrong pipe size causing the timing to be in error. The site data needs to be checked and the instrument reprogrammed.

5.3.2 W2: Signal timing poor

Unstable signal timing or differing up/down stream times indicate that the liquid is aerated or pipe surface is of poor quality.

5.3.3 W3: No prop signal

This occurs when the fixed transducer is unable to transmit and receive a signal across the pipe, for the same reasons as explained in E2. The instrument is capable of measuring the sound propagation rate of the liquid (See 4.6.8.11). The message will only appear when the user has asked the instrument to make this measurement and not when a fluid type has been selected from the list or the black sensor cable is not connected.

5.3.4 W4: RS232 not ready

This occurs when the equipment that is connected to the UFM 610 P via the RS232 is off line. Check the connections and that ancillary equipment has been switched on.

5.3.5 W5: Log memory full

This occurs when all memory blocks in the 112K built data logger have been used up. (To clear the memory see 3.5.8).

5.3.6 W6: Flow signals poor

This warning appears when there is a signal lower than 25%. This could be due to the application, a poor quality pipe, amongst others.

5.3.7 W7: mA out average

The mA output is overrange when the flow is higher than the maximum mA range. Once the 4-20mA range is set up and the flow goes above the range set then this message will appear. It is possible to re-scale the 4-20mA to be able to cope with the higher flow.

5.3.8 W8: Pulses at maximum

This message occurs when the pulses have been set up and the flow is higher than the maximum that has been set. It is possible to be able to re-scale the pulse output to cope with the higher flow.

5.3.9 W9: Battery low

The battery low warning occurs when battery indication is on 20%. This leaves the instrument with approximately 30 minutes usage before it needs recharging.

5.3.10 W10: No temp signal

Inside the transducer block is a temperature sensor that monitors the application temperature. When it is not connected between the electronics and the sensor, then the above error message is displayed.

5.3.11 W11: mA load to high

The 4-20mA output is designed to work with a load up to 750Ω. When the load is too high or not connected, the above warning message will be displayed.

5.4 Other messages

The messages below appear mainly when data has been incorrectly entered or the UFM 610 P is trying to be used on an application that it is not capable of working on.

5.4.1 Pipe OD out of range

The outside diameter of the pipe has been entered and is out of range of the instrument.

5.4.2 Wall thickness out of range

The wall thickness that has been entered is out of range of the instrument.

5.4.3 No data exists for this sensor

A sensor has been selected that is not available for use.

5.4.4 Lining thickness out of range

The pipe lining thickness has been incorrectly entered.

5.4.5 Site range is 1-20

There are only 20 storage sites available with 0 being the QUICK START site.

5.4.6 Cannot read flow because

- **CANNOT READ FLOW BECAUSE**
Pipe dimensions are invalid
- **CANNOT READ FLOW BECAUSE**
Materials are invalid
- **CANNOT READ FLOW BECAUSE**
Pipe is too large for sensor set
- **CANNOT READ FLOW BECAUSE**
Pipe is too small for sensor set
- **CANNOT READ FLOW BECAUSE**
Sensor mode is invalid for this pipe size

5.4.7 Temperature range -20 °C to +200 °C

The temperature range of the transducers is -20 °C to +200 °C.

5.4.8 Logging has started

This will only appear if the instrument has been supplied with a logger.

5.4.9 Enter a lining thickness first

This message appears when in VIEW/EDIT SITE DATA the user has tried to enter a pipe lining material before entering a thickness.

6. APPLICATION INFORMATION

The UFM 610 P is a Transit Time ultrasonic flowmeter that has been designed to work with Clamp On transducers, thus enabling liquid flowing within a closed pipe to be measured accurately without the need for any mechanical parts to be inserted either through the pipe wall or protrude into the flow system. The meter is controlled by a micro-processor containing a wide range of data which enables the instrument to measure flow in any pipe diameter from 13mm bore up to 5000mm, made of any material and over a wide range of operating temperatures.

The system operates as follows:

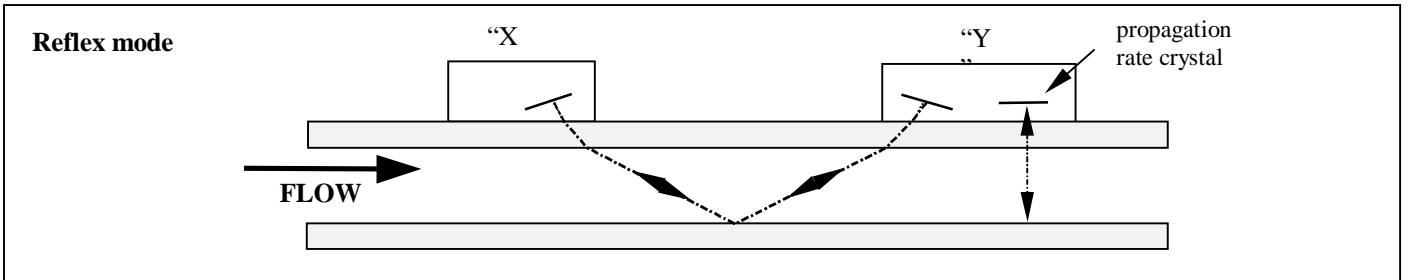

Figure 13

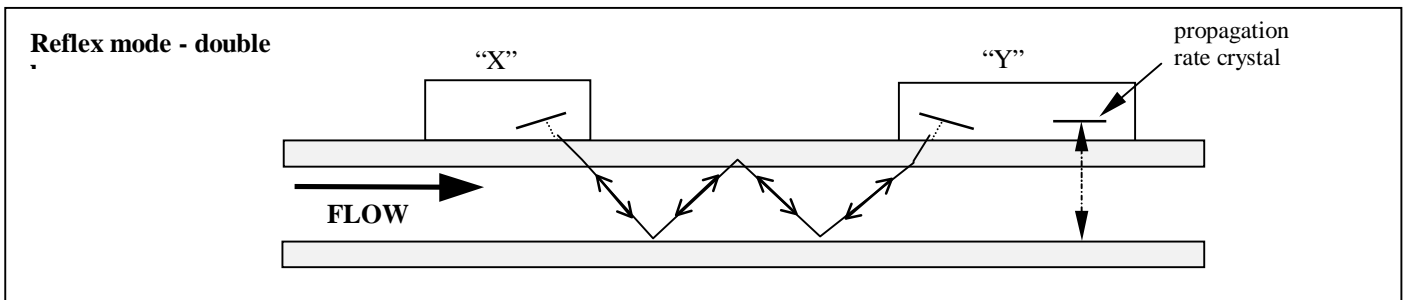

Figure 14

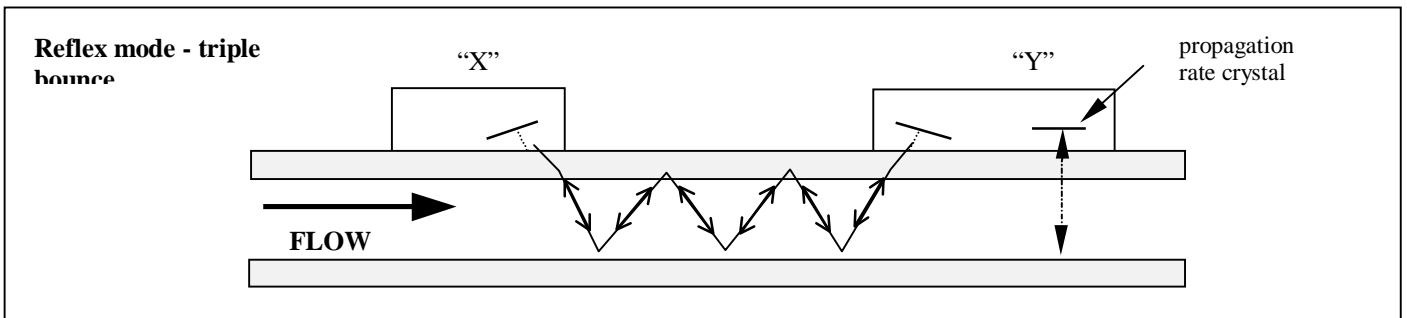

Figure 15

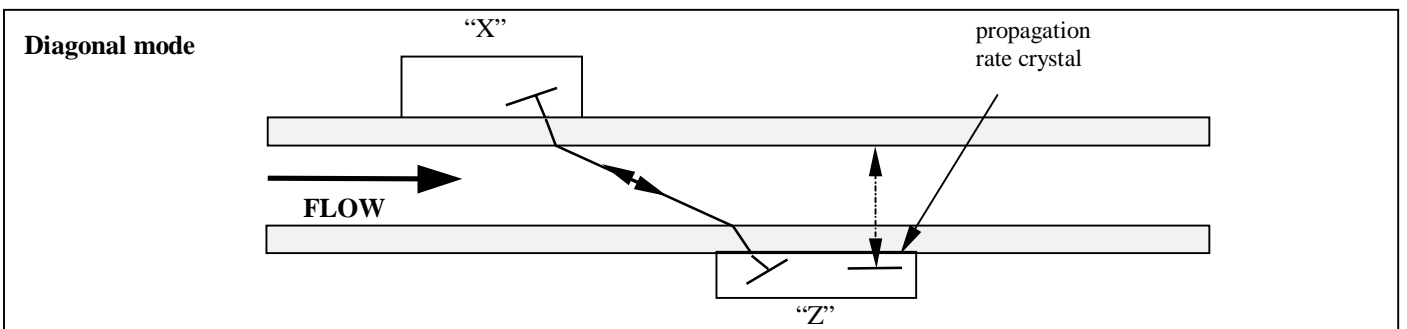

Figure 16

When ultrasound is transmitted from Transducer “X” to Transducer “Y” (REFLEX MODE) or Transducer “X” to “Z” (DIAGONAL MODE) the speed at which the sound travels through the liquid is accelerated slightly by the velocity of the liquid. If sound is transmitted in the opposite direction from “Y” to “X” or “Z” to “X”, it is decelerated because it is travelling against the flow of the liquid. The difference in time taken to travel the same distance but in opposite directions is directly proportional to the flow velocity of the liquid.

Having measured the flow velocity and knowing the pipe cross-sectional area, the volumetric flow can be easily calculated. All of the calculations required to first determine the correct alignment of the transducers and subsequently compute the actual flow are carried out by the microprocessor. To measure flow, it is first necessary to obtain detailed information about each application, which is then programmed into the processor via the Key Pad. This information must be accurate otherwise flow measurement errors will occur.

Further, having calculated the precise position at which the transducers must be clamped onto the pipe wall, it is equally important to align and separate the transducers accurately with respect to one another, as failing to do so will again cause errors in measurement.

Finally to ensure accurate flow measurement it is imperative that the liquid is flowing uniformly within the pipe and that the flow profile has not been distorted by any upstream or downstream obstructions. To obtain the best results from the UFM 610 P it is absolutely necessary that the following rules for positioning the transducers are adhered to and that the condition of the liquid and the pipe wall are suitable to allow transmission of the sound along its predetermined path.

6.1 Transducer

As the transducers for the UFM 610 P are clamped to the outside surface of the pipe, the meter has no way of determining exactly what is happening to the liquid. The assumption therefore has to be made that the liquid is flowing uniformly along the pipe either under fully turbulent conditions or under laminar flow conditions. Further it is assumed that the flow velocity profile is uniform for 360 ° around the pipe axis.

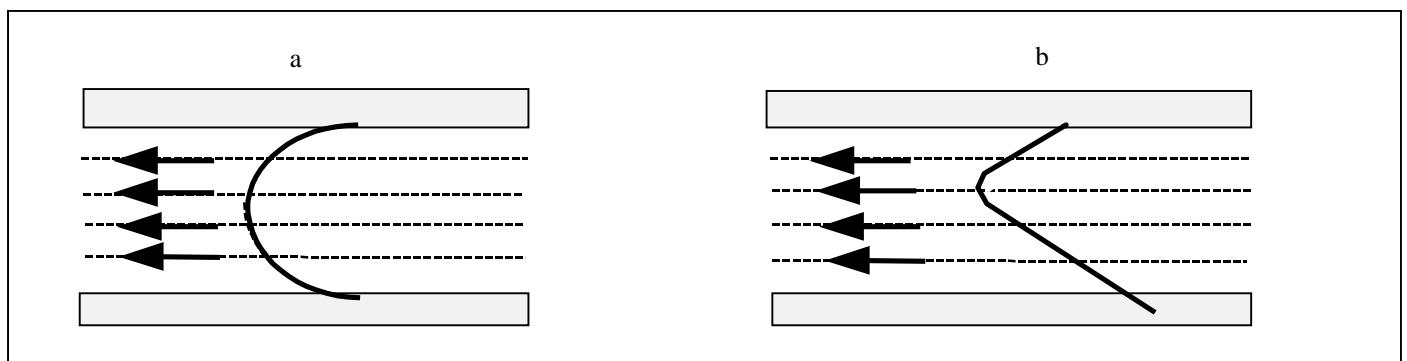

Figure 17 - shows an uniform profile as compared to a distorted profile.

The difference between (a) and (b) is that the Mean Velocity of the flow across the pipe is different and because the UFM 610 P expects a uniform flow as in (a), the distorted flow as in (b) will give measurement errors which cannot be predicted or compensated for. Flow profile distortions result from upstream disturbances such as bends, tees, valves, pumps and other similar obstructions. To ensure a uniform profile the transducers must be mounted far enough away from any cause of distortion such that it no longer has an effect.

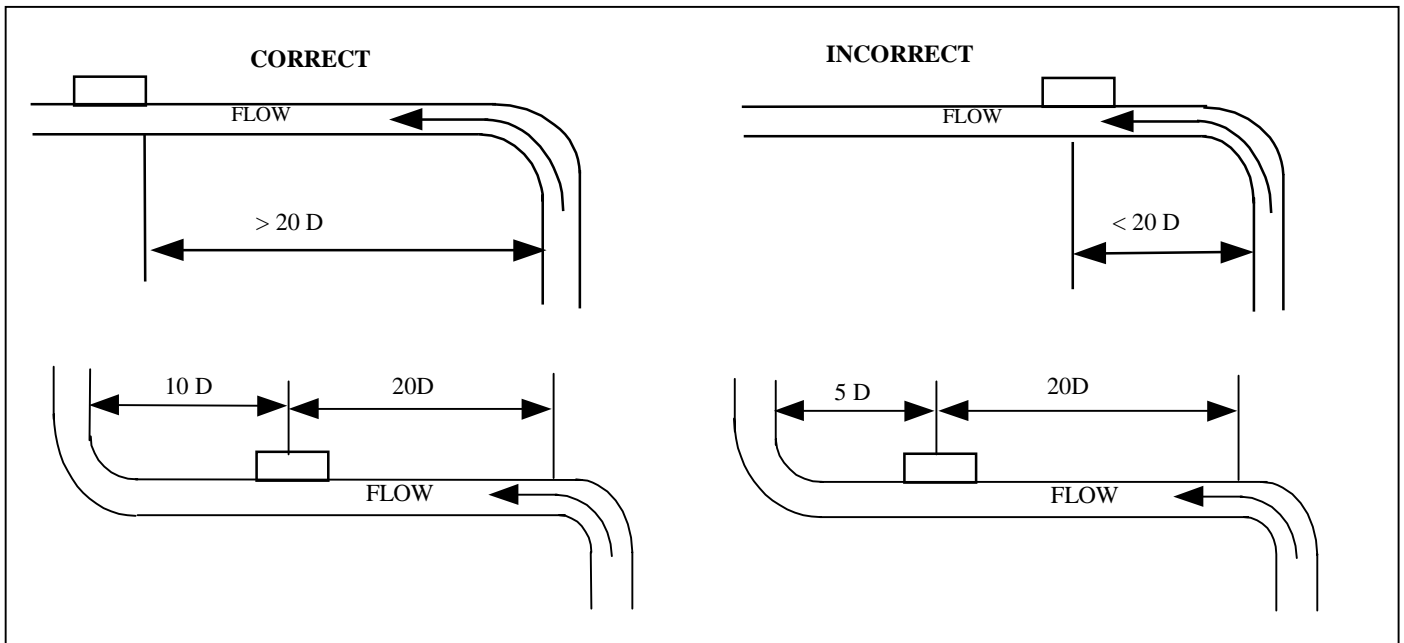

Figure 18 The minimum length of upstream straight pipe is 20 Diameters and 10 Diameters downstream which ensures that accurate results will be achieved. Flow measurements can be made on shorter lengths of straight pipe down to 10 Diameters upstream and 5 Diameters downstream, but when the transducers are sighted this close to any obstruction errors can be considerable.

It is not possible to predict the amount of error as this depends entirely upon the type of obstruction and the configuration of the pipework. The message therefore is clear: Do not expect to obtain accurate results if the transducers are positioned closer than allowed to any obstruction that distorts the uniformity of the flow profile.

6.2 Mounting the transducers

It will be impossible to achieve the accuracy of measurement specified for the UFM 610 P if the transducers are not clamped to the pipe correctly and if the data - O.D., Wall Thickness, Pipe Material and Product - are not accurate.

Apart from the correct positioning and alignment of the transducers, of equal importance is the condition of the pipe surface in the area under each of the transducers.

An uneven surface that prevents the transducers from sitting flat on the surface of the pipe can cause Signal Level and Zero Offset problems. The following procedure is offered as a guide to good practice with respect to positioning and mounting the transducers.

1. Select the site following the rules laid down as above - Transducer Positioning.
2. Inspect the surface of the pipe to ensure it is free from rust or is not uneven for any reason. Transducers can be mounted directly on painted surfaces as long as the surface is smooth and that the underlying metal surface is free from rust bubbles. On bitumen or rubber coated pipes the coating must be removed in the area under the transducers, as it is preferable that the transducers are mounted directly on to the base metal.
3. Transducers can be mounted on both Vertical and Horizontal Pipe Runs.

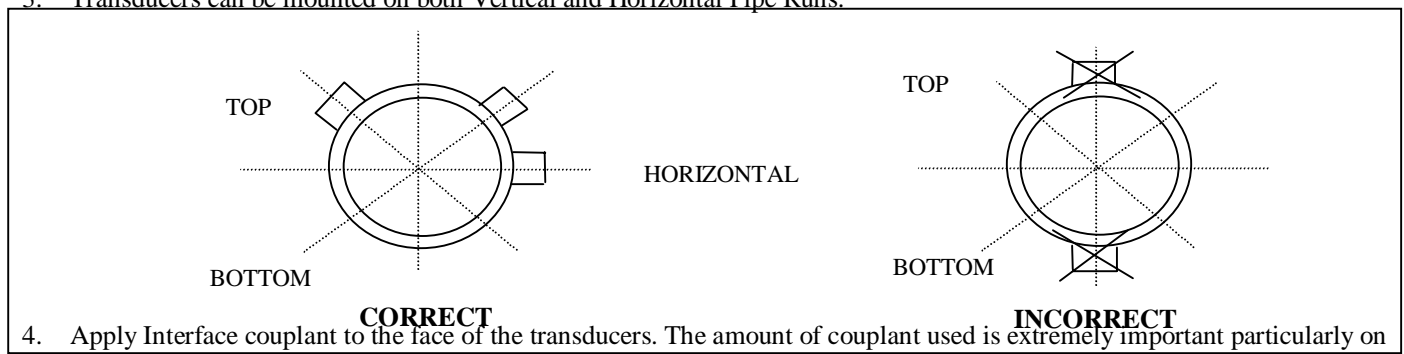

4. Apply Interface couplant to the face of the transducers. The amount of couplant used is extremely important particularly on pipes of less than 89mm bore.

6.2.1 Transducer set "A"

fixed sensor block

moveable sensor block

For all small pipes below 89mm, using 2MHz transducers, the bead of couplant used must be approximately 20mm long and 2mm maximum diameter for the moveable sensor and 30 long and 2mm diameter for the fixed sensor. Using more couplant could cause wall signals to be generated which cause errors in measurement. On Stainless Steel Pipes the amount of couplant applied should never exceed the amount indicated in the Examples above. For large Plastic and Steel Pipes the amount of couplant applied is less critical, however do not use more than is absolutely necessary.

6.2.2 Transducer set "B" and "C"

The main difference between transducer set "B" and "C" is the angle that the crystal has been inserted in the sensor block itself.

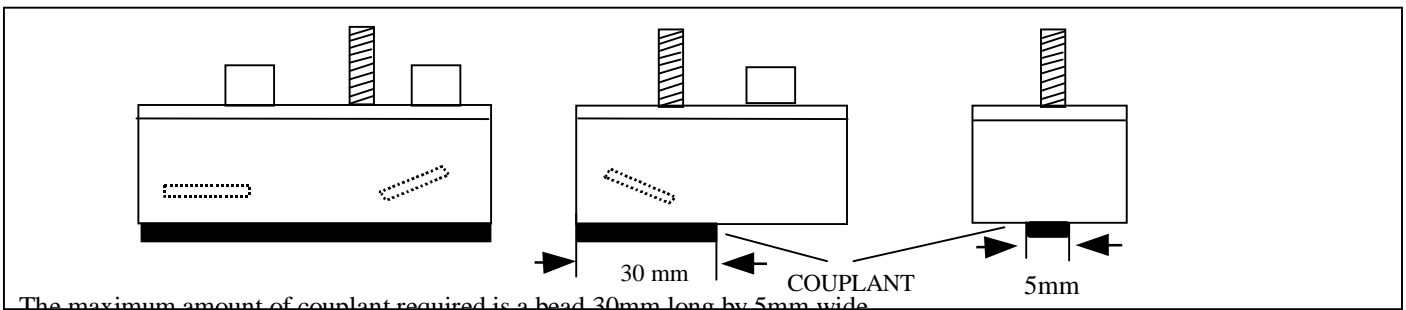

The maximum amount of couplant required is a bead 30mm long by 5mm wide.

Figure 21

6.2.3 Transducer set "D"

The two 0.5 MHz transducer blocks are the same, there is no propagation rate measurement required when using transducer set "D".

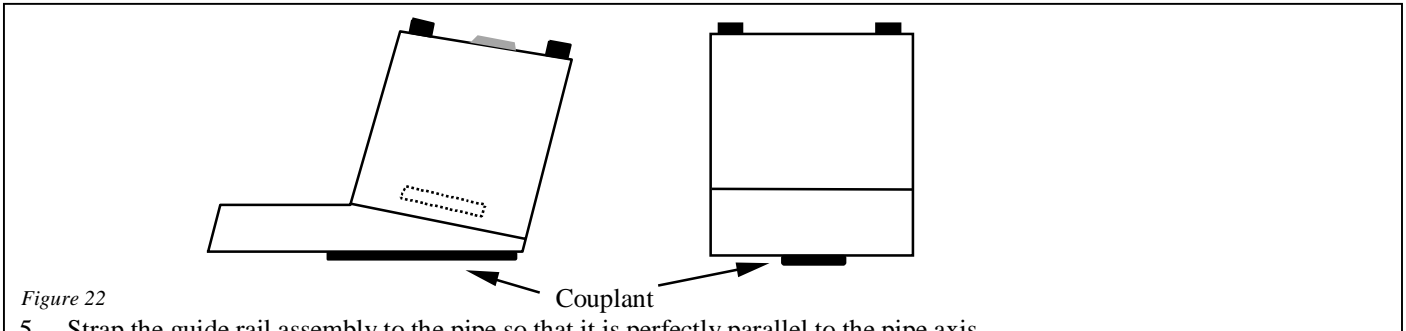

Figure 22

5. Strap the guide rail assembly to the pipe so that it is perfectly parallel to the pipe axis.

6. When screwing the transducers on to the pipe surface use only enough force to ensure that the Transducer is flat against the pipe surface and then lock in position.
7. Clamping the transducers in exactly the correct position is extremely important. The Separation Distance is calculated by the UFM 610 P and the transducers must be positioned and clamped exactly at the distance specified.
8. Always use the couplant provided.

6.3 Liquid conditions

Transit time ultrasonic meters perform best on liquids that are totally free from entrained air and solids. With sufficient air in the system the ultrasound beam can be attenuated totally and therefore prevent the instrument from working. Often it is possible to tell whether there is air in the system or not. If a flow signal cannot be obtained a simple test to determine whether the flow is aerated involves stopping the flow for a period of 10 - 15 minutes. During this time the air bubbles will rise to the top of the pipe and the flow signal should return. If the flow signal does return switch on the flow and if sufficient entrained air is locked in the system it will very quickly disperse and kill the signal.

6.4 Reynolds number

The UFM 610 P has been calibrated to operate on Turbulent flows with Reynolds No. of approximately 100,000. When the Reynolds No. decreases to approximately 4000-5000 the instrument calibration is no longer valid. If the UFM 610 P is to be used on laminar flow applications it will be necessary to calculate the Reynolds No. for each application. To calculate the Reynolds No. it is necessary to know the Kinematic viscosity in Centistokes; the flow velocity and the pipe inside diameter.

To calculate R_e use the following formula: $R_e = \frac{dv}{\nu^1} (7730)$ or $R_e = \frac{d^1 v^1}{\nu^1} (1000)$

Where d = inside pipe diameter in inches

ν^1 = velocity in metres/second

d^1 = inside pipe diameter in millimetres

ν^1 = Kinematic viscosity in centistokes

v = velocity in feet/second

To correct the UFM 610 P for operation in the laminar flow region, calculate the Reynolds No. and adjust the correction factor as described on 4.6.7 - Options.

6.5 Propagation velocity

To make a flow measurement using the UFM 610 P on any liquid, it is necessary to know the propagation velocity in metres/second. There is a short list of fluids that appear on the display when programming (See page 16), showing water and various other liquids. However if the liquid you wish to measure is not on this list, by selecting **measure**, the instrument measures the propagation rate itself but only for pipe internal diameter greater 40 mm, by selecting **Other** it is possible to enter the propagation rate in m/sec, if known.

6.6 Maximum flow

The maximum flow is dependent on the velocity and pipe size.

6.7 Application temperature

On any application whose operating temperature is either above or below ambient temperature ensure that the transducers reach and are maintained at the application temperature before undertaking a measurement. Transducer sets "A", "B" and "C" have a temperature sensor inside the block that needs to reach the application temperature before making a measurement. If the block is not up to application temperature it could effect the separation distance and therefore the accuracy. When applying the transducers to low temperature applications do not allow the pipe surface to ice up between the transducer and the pipe wall. The ice will force the block away from the pipe wall and consequently you will lose the signal.

6.8 Flow range

6.8.1 Transducer set "A"

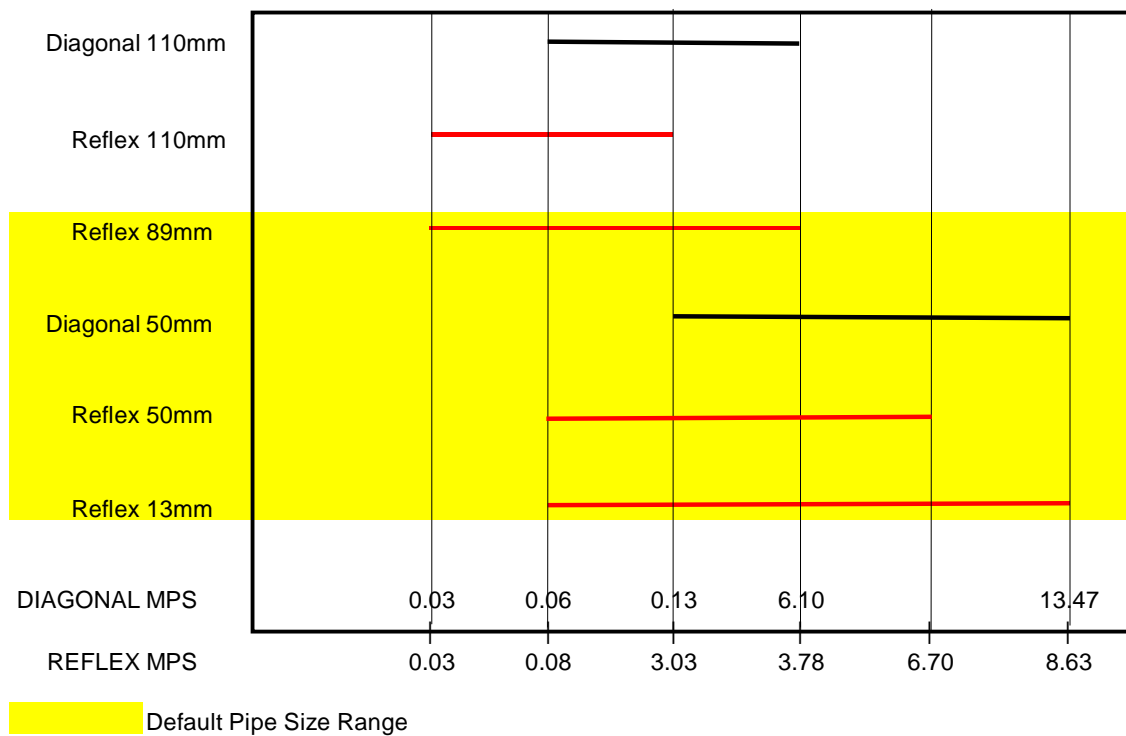

Figure 23

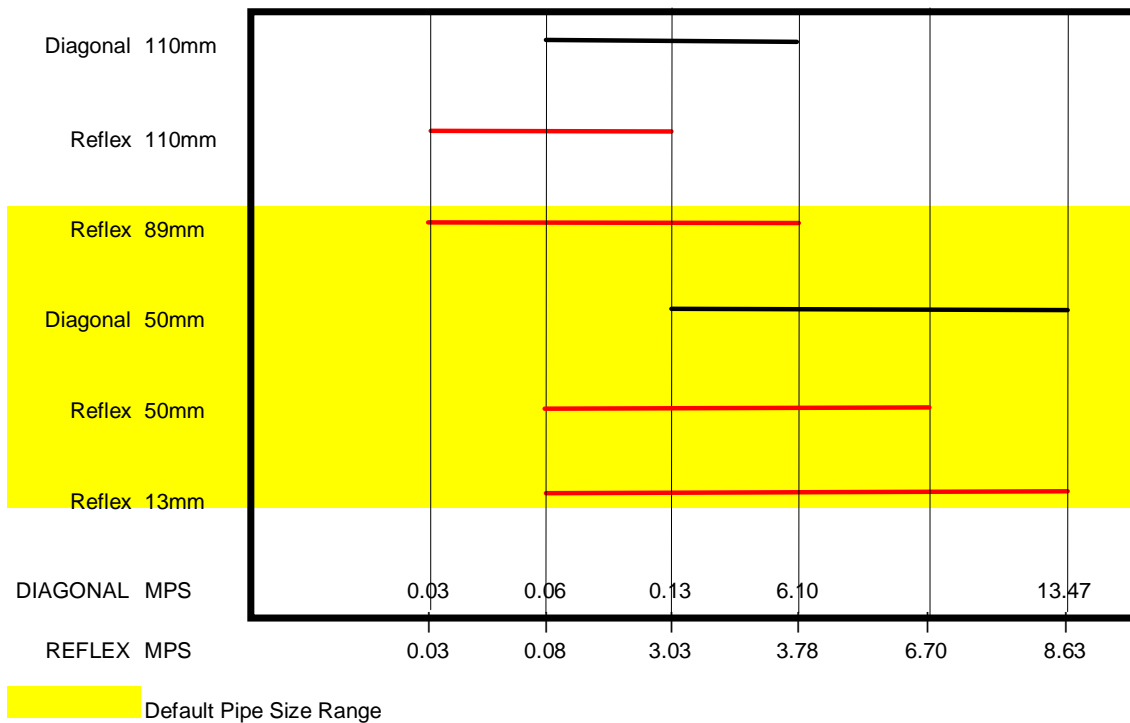

Figure 24

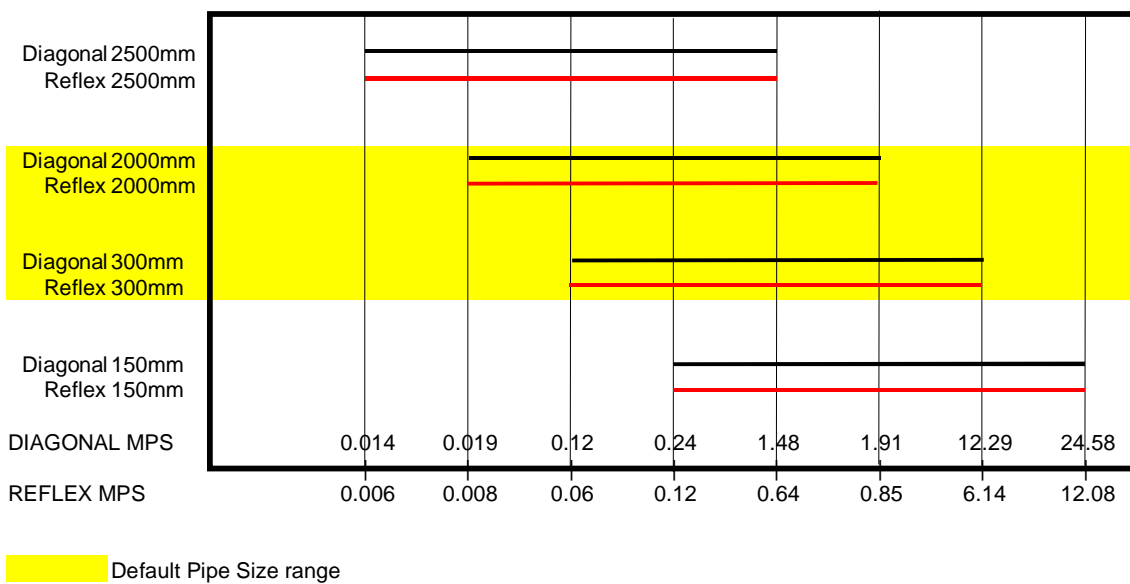

Figure 25

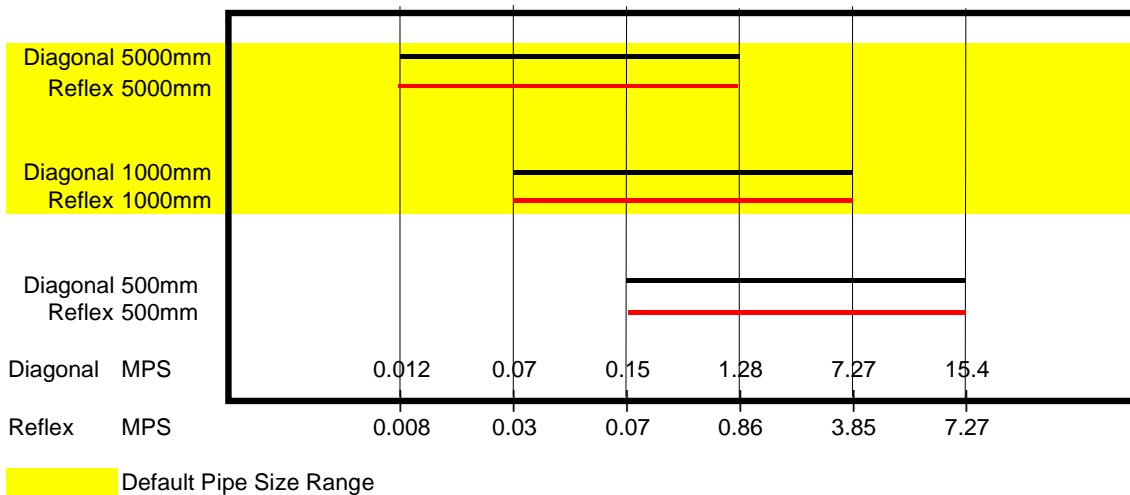

Figure 26

6.9 Liquid sound speed

Liquid Sound Speeds at 25°C				
Substance	Form Index	Specific Gravity	Sound Speed	$\Delta v/^\circ\text{C}$ -m/s/°C
Acetic anhydride	(CH ₃ CO) ₂ O	1.082 (20°C)	1180	2.5
Acetic acid, anhydride	(CH ₃ CO) ₂ O	1.082 (20°C)	1180	2.5
Acetic acid, nitrile	C ₂ H ₃ N	0.783	1290	4.1
Acetic acid, ethyl ester	C ₄ H ₈ O ₂	0.901	1085	4.4
Acetic acid, methyl ester	C ₃ H ₆ O ₂	0.934	1211	
Acetone	C ₃ H ₆ O	0.791	1174	4.5
Acetonitrile	C ₂ H ₃ N	0.783	1290	4.1
Acetylacetone	C ₆ H ₁₀ O ₂	0.729	1399	3.6
Acetylene dichloride	C ₂ H ₂ Cl ₂	1.26	1015	3.8
Acetylene tetrabromide	C ₂ H ₂ Br ₄	2.966	1027	
Acetylene tetrachloride	C ₂ H ₂ Cl ₄	1.595	1147	
Alcohol	C ₂ H ₆ O	0.789	1207	4.0
Alkazene-13	C ₁₅ H ₂₄	0.86	1317	3.9
Alkazene-25	C ₁₀ H ₁₂ Cl ₂	1.20	1307	3.4
2-Amino-ethanol	C ₂ H ₇ NO	1.018	1724	3.4
2-Aminotolidine	C ₇ H ₆ N	0.999 (20°C)	1618	
4-Aminotolidine	C ₇ H ₆ N	0.966 (45°C)	1480	
Ammonia	NH ₃	0.771	1729	6.68
Amorphous Polyolefin		0.98	962.6	
t-Amyl alcohol	C ₅ H ₁₂ O	0.81	1204	
Aminobenzene	C ₆ H ₅ NO ₂	1.022	1639	4.0
Aniline	C ₆ H ₅ NO ₂	1.022	1639	4.0
Argon	Ar	1.400 (-188°C)	853	
Azine	C ₆ H ₅ N	0.982	1415	4.1
Benzene	C ₆ H ₆	0.879	1306	4.65
Benzol	C ₆ H ₆	0.879	1306	4.65
Bromine	Br ₂	2.928	889	3.0
Bromo-benzene	C ₆ H ₅ Br	1.522	1170	
1-Bromo-butane	C ₄ H ₉ Br	1.276 (20°C)	1019	
Bromo-ethane	C ₂ H ₅ Br	1.460 (20°C)	900	
Bromofom	CHBr ₃	2.89 (20°C)	918	3.1
n-Butane	C ₄ H ₁₀	0.601 (0°C)	1085	5.8
2-Butanol	C ₄ H ₁₀ O	0.81	1240	3.3
sec-Butylalcohol	C ₄ H ₁₀ O	0.81	1240	3.3
n-Butyl bromide	C ₄ H ₉ Br	1.276 (20°C)	1019	
n-Butyl chloride	C ₄ H ₉ Cl	0.887	1140	4.57
tert Butyl chloride	C ₄ H ₉ Cl	0.84	984	4.2
Butyl oleate	C ₂₂ H ₄₂ O ₂		1404	3.0
2,3 Butylene glycol	C ₄ H ₁₀ O ₂	1.019	1484	1.51
Cadmium	Cd		2237.7	
Carbinol	CH ₄ O	0.791 (20°C)	1076	2.92
Carbitol	C ₆ H ₁₄ O ₃	0.988	1458	
Carbon dioxide	CO ₂	1.101 (-37°C)	839	7.71
Carbon disulphide	CS ₂	1.261 (22°C)	1149	
Carbon tetrachloride	CCl ₄	1.595 (20°C)	926	2.48
Carbon tetrafluoride	CF ₄	1.75 (-150°C)	875.2	6.61
Cetane	C ₁₆ H ₃₄	0.773 (20°C)	1338	3.71
Chloro-benezene	C ₆ H ₅ Cl	1.106	1273	3.6
1-Chloro-butane	C ₄ H ₉ Cl	0.887	1140	4.57
Chloro-diFluoromethane (Freon 22)	CHClF ₂	1.491 (-69°C)	893.9	4.79
Chloroform	CHCl ₃	1.489	979	3.4
1-Chloro-propane	C ₃ H ₇ Cl	0.892	1058	
Chlorotrifluoromethane	CClF ₃		724	5.26
Cinnamaldehyde	C ₉ H ₈ O	1.112	1554	3.2
Cinnamic aldehyde	C ₉ H ₈ O	1.112	1554	3.2
Colamine	C ₂ H ₇ NO	1.018	1724	3.4
o-Cresol	C ₇ H ₈ O	1.047 (20°C)	1541	
m-Cresol	C ₇ H ₈ O	1.034 (20°C)	1500	
Cyanomethane	C ₂ H ₃ N	0.783	1290	4.1
Cyclohexane	C ₆ H ₁₂	0.779 (20°C)	1248	5.41
Cyclohexanol	C ₆ H ₁₂ O	0.962	1454	3.6
Cyclohexanone	C ₆ H ₁₀ O	0.948	1423	4.0

Decane	C ₁₀ H ₂₂	0.730	1252	
1-Decene	C ₁₀ H ₂₀	0.746	1235	4.0
n-Decylene	C ₁₀ H ₂₀	0.746	1235	4.0
Diacetyl	C ₄ H ₆ O ₂	0.99	1236	4.6
Diamylamine	C ₁₀ H ₂₃ N		1256	3.9
1,2 Dibromo-ethane	C ₂ H ₄ Br ₂	2.18	995	
trans-1,2-Dibromoethene	C ₂ H ₂ Br ₂	2.231	935	
Dibutyl phthalate	C ₈ H ₂₂ O ₄		1408	
Dichloro-t-butyl alcohol	C ₄ H ₈ Cl ₂ O		1304	3.8
2,3 Dichlorodioxane	C ₂ H ₆ Cl ₂ O ₂		1391	3.7
Dichlorodifluoromethane (Freon 12)	CCl ₂ F ₂	1.516 (-40°C)	774.1	4.24
1,2 Dichloro ethane	C ₂ H ₄ Cl ₂	1.253	1193	
cis 1,2-Dichloro-Ethene	C ₂ H ₂ Cl ₂	1.284	1061	
trans 1,2-Dichloro-ethene	C ₂ H ₂ Cl ₂	1.257	1010	
Dichloro-fluoromethane (Freon 21)	CHCl ₂ F	1.426 (0°C)	891	3.97
1-2-Dichlorohexafluoro cyclobutane	C ₄ Cl ₂ F ₆	1.654	669	
1-3-Dichloro-isobutane	C ₄ H ₈ Cl ₂	1.14	1220	3.4

Dichloro methane	CH ₂ Cl ₂	1.327	1070	3.94
1,1-Dichloro-1,2,2,2 tetra fluoroethane	CClF ₂ -CClF ₂	1.455	665.3	3.73
Diethyl ether	C ₄ H ₁₀ O	0.713	985	4.87
Diethylene glycol, monoethyl ether	C ₆ H ₁₄ O ₃	0.988	1458	
Diethylenimide oxide	C ₄ H ₉ NO	1.00	1442	3.8
1,2-bis(DiFluoramino) butane	C ₄ H ₈ (NF ₂) ₂	1.216	1000	
1,2bis(DiFluoramino)- 2-methylpropane	C ₄ H ₉ (NF ₂) ₂	1.213	900	
1,2bis(DiFluoramino) propane	C ₃ H ₆ (NF ₂) ₂	1.265	960	
2,2bis(DiFluoramino) propane	C ₃ H ₆ (NF ₂) ₂	1.254	890	
2,2-Dihydroxydiethyl ether	C ₄ H ₁₀ O ₃	1.116	1586	2.4
Dihydroxyethane	C ₂ H ₆ O ₂	1.113	1658	2.1
1,3-Dimethyl-benzene	C ₈ H ₁₀	0.868 (15°C)	1343	
1,2-Dimethyl-benzene	C ₈ H ₁₀	0.897 (20°C)	1331.5	4.1
1,4-Dimethyl-benzene	C ₈ H ₁₀		1334	
2,2-Dimethyl-butane	C ₆ H ₁₄	0.649 (20°C)	1079	
Dimethyl ketone	C ₃ H ₆ O	0.791	1174	4.5
Dimethyl pentane	C ₇ H ₁₆	0.674	1063	
Dimethyl phthalate	C ₈ H ₁₀ O ₄	1.2	1463	
Diiodo-methane	CH ₂ I ₂	3.235	980	
Dioxane	C ₄ H ₈ O ₂	1.033	1376	
Dodecane	C ₁₂ H ₂₆	0.749	1279	3.85
1,2-Ethanediol	C ₂ H ₆ O ₂	1.113	1658	2.1
Ethanenitrile	C ₂ H ₃ N	0.783	1290	
Ethanoic anhydride	(CH ₃ CO) ₂ O	1.082	1180	
Ethanol	C ₂ H ₆ O	0.789	1207	4.0
Ethanol amide	C ₂ H ₇ NO	1.018	1724	3.4
Ethoxyethane	C ₄ H ₁₀ O	0.713	985	4.87
Ethyl acetate	C ₄ H ₈ O ₂	0.901	1085	4.4
Ethyl alcohol	C ₂ H ₆ O	0.789	1207	4.0
Ethyl benzene	C ₈ H ₁₀	0.867(20°C)	1338	
Ethyl bromide	C ₂ H ₅ Br	1.461 (20°C)	900	
Ethyl iodide	C ₂ H ₅ I	1.950 (20°C)	876	
Ether	C ₄ H ₁₀ O	0.713	985	4.87
Ethyl ether	C ₄ H ₁₀ O	0.713	985	4.87
Ethylene bromide	C ₂ H ₄ Br ₂	2.18	995	
Ethylene chloride	C ₂ H ₄ Cl ₂	1.253	1193	
Ethylene glycol	C ₂ H ₆ O ₂	1.113	1658	2.1
50% Glycol/ 50% H ₂ O			1578	
d-Fenochone	C ₁₀ H ₁₆ O	0.947	1320	
d-2-Fenochanone	C ₁₀ H ₁₆ O	0.947	1320	
Fluorine	F	0.545 (-143°C)	403	11.31
Fluoro-benzene	C ₆ H ₅ F	1.024 (20°C)	1189	
Formaldehyde, methyl ester	C ₂ H ₄ O ₂	0.974	1127	4.02
Formamide	CH ₃ NO	1.134 (20°C)	1622	2.2
Formic acid, amide	CH ₃ NO	1.134 (20°C)	1622	
Freon R12			774	
Furfural	C ₅ H ₄ O ₂	1.157	1444	
Furfuryl alcohol	C ₅ H ₆ O ₂	1.135	1450	3.4
Fural	C ₅ H ₄ O ₂	1.157	1444	3.7

2-Furaldehyde	C ₅ H ₄ O ₂	1.157	1444	3.7
2-Furancarboxaldehyde	C ₅ H ₄ O ₂	1.157	1444	3.7
2-Furyl-Methanol	C ₅ H ₆ O ₂	1.135	1450	3.4
Gallium	Ga	6.095	2870 (@30°C)	
Glycerin	C ₃ H ₈ O ₃	1.26	1904	2.2
Glycerol	C ₃ H ₈ O ₃	1.26	1904	2.2
Glycol	C ₂ H ₆ O ₂	1.113	1658	2.1
Helium	He ₄	0.125(-268.8°C)	183	
Heptane	C ₇ H ₁₆	0.684 (20°C)	1131	4.25
n-Heptane	C ₇ H ₁₆	0.684 (20°C)	1180	4.0
Hexachloro-Cyclopentadiene	C ₅ Cl ₆	1.7180	1150	
Hexadecane	C ₁₆ H ₃₄	0.773 (20°C)	1338	3.71
Hexalin	C ₆ H ₁₂ O	0.962	1454	3.6
Hexane	C ₆ H ₁₄	0.659	1112	2.71
n-Hexane	C ₆ H ₁₄	0.649 (20°C)	1079	4.53
2,5-Hexanedione	C ₆ H ₁₀ O ₂	0.729	1399	3.6
n-Hexanol	C ₆ H ₁₄ O	0.819	1300	3.8
Hexahydrobenzene	C ₆ H ₁₂	0.779	1248	5.41
Hexahydrophenol	C ₆ H ₁₂ O	0.962	1454	3.6
Hexamethylene	C ₆ H ₁₂	0.779	1248	5.41
Hydrogen	H ₂	0.071 (-256°C)	1187	
2-Hydroxy-toluene	C ₇ H ₈ O	1.047 (20°C)	1541	
3-Hydroxy-toluene	C ₇ H ₈ O	1.034 (20°C)	1500	
Iodo-benzene	C ₆ H ₅ I	1.823	1114	
Iodo-ethane	C ₂ H ₅ I	1.950 (20°C)	876	
Iodo-methane	CH ₃ I	2.28 (20°C)	978	
Isobutyl acetate	C ₆ H ₁₂ O		1180	4.85
Isobutanol	C ₄ H ₁₀ O	0.81 (20°C)	1212	
Iso-Butane			1219.8	
Isopentane	C ₅ H ₁₂	0.62 (20°C)	980	4.8
Isopropanol	C ₃ H ₈ O	0.785 (20°C)	1170	
Isopropyl alcohol	C ₃ H ₈ O	0.785 (20°C)	1170	
Kerosene		0.81	1324	3.6
Ketohexamethylene	C ₆ H ₁₀ O	0.948	1423	4.0
Lithium fluoride	LiF		2485	1.29
Mercury	Hg	13.594	1449	

Mesityloxide	C ₆ H ₁₆ O	0.85	1310	
Methane	CH ₄	0.162	405(-89.15°C)	17.5
Methanol	CH ₄ O	0.791 (20°C)	1076	2.92
Methyl acetate	C ₃ H ₆ O ₂	0.934	1211	
o-Methylaniline	C ₇ H ₉ N	0.999 (20°C)	1618	
4-Methylaniline	C ₇ H ₉ N	0.966 (45°C)	1480	
Methyl alcohol	CH ₄ O	0.791 (20°C)	1076	2.92
Methyl benzene	C ₇ H ₈	0.867	1328	4.27
2-Methyl-butane	C ₅ H ₁₂	0.62 (20°C)	980	
Methyl carbinol	C ₂ H ₆ O	0.789	1207	4.0
Methyl-chloroform	C ₂ H ₃ Cl ₃	1.33	985	
Methyl-cyanide	C ₂ H ₃ N	0.783	1290	
3-Methyl cyclohexanol	C ₇ H ₁₄ O	0.92	1400	
Methylene chloride	CH ₂ Cl ₂	1.327	1070	3.94
Methylene iodide	CH ₂ I ₂	3.235	980	
Methyl formate	C ₂ H ₄ O ₂	0.974 (20°C)	1127	4.02
Methyl iodide	CH ₃ I	2.28 (20°C)	978	
α-Methyl naphthalene	C ₁₁ H ₁₀	1.090	1510	3.7
2-Methylphenol	C ₇ H ₈ O	1.047 (20°C)	1541	
3-Methylphenol	C ₇ H ₈ O	1.034 (20°C)	1500	
Milk, homogenized			1548	
Morpholine	C ₄ H ₉ NO	1.00	1442	3.8
Naphtha		0.76	1225	
Natural Gas		0.316 (-103°C)	753	
Neon	Ne	1.207 (-246°C)	595	
Nitrobenzene	C ₆ H ₅ NO ₂	1.204 (20°C)	1415	
Nitrogen	N ₂	0.808 (-199°C)	962	
Nitromethane	CH ₃ NO ₂	1.135	1300	4.0
Nonane	C ₉ H ₂ O	0.718 (20°C)	1207	4.04
1-Nonene	C ₉ H ₁₈	0.736 (20°C)	1207	4.0

Octane	C ₈ H ₁₈	0.703	1172	4.14
n-Octane	C ₈ H ₁₈	0.704 (20°C)	1212.5	3.50
1-Octene	C ₈ H ₁₆	0.723 (20°C)	1175.5	4.10
Oil of Camphor Sassafrassy			1390	3.8
Oil, Car (SAE 20a.30)	1.74		870	
Oil, Castor	C ₁₁ H ₁₀ O ₁₀	0.969	1477	3.6
Oil, Diesel		0.80	1250	
Oil, Fuel AA gravity		0.99	1485	3.7
Oil (Lubricating X200)			1530	5019.9
Oil (Olive)		0.912	1431	2.75
Oil (Peanut)		0.936	1458	
Oil (Sperm)		0.88	1440	
Oil, 6			1509	
2,2-Oxydiethanol	C ₄ H ₁₀ O ₃	1.116	1586	2.4
Oxygen	O ₂	1.155 (-186°C)	952	
Pentachloro-ethane	C ₂ HCl ₅	1.687	1082	
Pentalin	C ₂ HCl ₅	1.687	1082	
Pentane	C ₅ H ₁₂	0.626 (20°C)	1020	
n-Pentane	C ₅ H ₁₂	0.557	1006	
Perchlorocyclopentadiene	C ₅ Cl ₆	1.718	1150	
Perchloro-ethylene	C ₂ Cl ₄	1.632	1036	
Perfluoro-1-Hepten	C ₇ F ₁₄	1.67	583	
Perfluoro-n-Hexane	C ₆ F ₁₄	1.672	508	
Phene	C ₆ H ₆	0.879	1306	4.65
β-Phenyl acrolein	C ₉ H ₈ O	1.112	1554	3.2
Phenylamine	C ₆ H ₅ NO ₂	1.022	1639	4.0
Phenyl bromide	C ₆ H ₅ Br	1.522	1170	
Phenyl chloride	C ₆ H ₅ Cl	1.106	1273	3.6
Phenyl iodide	C ₆ H ₅ I	1.823	1114	
Phenyl methane	C ₇ H ₈	0.867 (20°C)	1328	4.27
3-Phenyl propenal	C ₉ H ₈ O	1.112	1554	3.2
Phthalardione	C ₈ H ₄ O ₃		1125	
Phthalic acid, anhydride	C ₈ H ₄ O ₃		1125	
Phthalic anhydride	C ₈ H ₄ O ₃		1125	
Pimelic ketone	C ₆ H ₁₀ O	0.948	1423	4.0
Plexiglas, Lucite, Acrylic			2651	
Polyterpene Resin		0.77	1099.8	
Potassium bromide	Kbr		1169	0.71
Potassium fluoride	KF		1792	1.03
Potassium iodide	KI		985	0.64
Potassium nitrate	KNO ₃	1.859 (352°C)	1740.1	1.1
Propane (-45 to -130°C)	C ₃ H ₈	0.585 (-45°C)	1003	5.7
1,2,3-Propanetriol	C ₃ H ₈ O ₃	1.26	1904	2.2
1-Propanol	C ₃ H ₈ O	0.78 (20°C)	1222	
2-Propanol	C ₃ H ₈ O	0.785 (20°C)	1170	
2-Propanone	C ₃ H ₆ O	0.791	1174	4.5
Propene	C ₃ H ₆	0.563 (-13°C)	963	6.32
n-Propyl acetate	C ₅ H ₁₀ O ₂	1.280 (2°C)	4.63	
n-Propyl alcohol	C ₃ H ₈ O	0.78 (20°C)	1222	
Propylchloride	C ₃ H ₇ Cl	0.892	1058	
Propylene	C ₃ H ₆	0.563 (-13°C)	963	6.32
Pyridine	C ₆ H ₅ N	0.982	1415	4.1
Refrigerant 11	CCl ₃ F	1.49	828.3	3.56
Refrigerant 12	CCl ₂ F ₂	1.516 (-40°C)	774.1	4.24
Refrigerant 14	CF ₄	1.75 (-150°C)	875.24	6.61

Refrigerant 21	CHCl ₂ F	1.426 (0°C)	891	3.97
Refrigerant 22	CHClF ₂	1.491 (-69°C)	893.9	4.79
Refrigerant 113	CCl ₂ F-CClF ₂	1.563	783.7	3.44
Refrigerant 114	CClF ₂ -CClF ₂	1.455	665.3	3.73
Refrigerant 115	C ₂ ClF ₅		656.4	4.42
Refrigerant C318	C ₄ F ₈	1.62 (-20°C)	574	3.88
Selenium	Se		1072	0.68
Silicone (30 cp)		0.993	990	
Sodium fluoride	NaF	0.877	2082	1.32
Sodium nitrate	NaNO ₃	1.884 (336°C)	1763.3	0.74
Sodium nitrite	NaNO ₂	1.805 (292°C)	1876.8	

Solvesso 3		0.877	1370	3.7
Spirit of wine	C ₂ H ₆ O	0.789	1207	4.0
Sulphur	S		1177	-1.13
Sulphuric acid	H ₂ SO ₄	1.841	1257.6	1.43
Tellurium	Te		991	0.73
1,1,2,2-Tetrabromo-ethane	C ₂ H ₂ Br ₄	2.966	1027	
1,1,2,2-Tetrachloro-ethane	C ₂ H ₂ Cl ₄	1.595	1147	
Tetrachloroethane	C ₂ H ₂ Cl ₄	1.553 (20°C)	1170	
Tetrachloro-ethene	C ₂ Cl ₄	1.632	1036	
Tetrachloro-methane	CCl ₄	1.595 (20°C)	926	
Tetradecane	C ₁₄ H ₃₀	0.763 (20°C)	1331	
Tetraethylene glycol	C ₈ H ₁₈ O ₅	1.123	1586/5203.4	3.0
Tetrafluoro-methane (Freon 14)	CF ₄	1.75 (-150°C)	875.24	6.61
Tetrahydro-1,4-isoxazine	C ₄ H ₆ NO		1442	3.8
Toluene	C ₇ H ₈	0.867 (20°C)	1328	4.27
o-Toluidine	C ₇ H ₉ N	0.999 (20°C)	1618	
p-Toluidine	C ₇ H ₉ N	0.966 (45°C)	1480	
Toluol	C ₇ H ₈	0.866	1308	4.2
Tribromo-methane	CHBr ₃	2.89 (20°C)	918	
1,1,1-Trichloro-ethane	C ₂ H ₃ Cl ₃	1.33	985	
Trichloro-ethene	C ₂ HCl ₃	1.464	1028	
Trichloro-fluoromethane (Freon 11)	CCl ₃ F	1.49	828.3	3.56
Trichloro-methane	CHCl ₃	1.489	979	3.4
1,1,2-Trichloro-1,2,2-Trifluoro-Ethane	CCl ₂ F-CClF ₂	1.563	783.7	
Triethyl-amine	C ₆ H ₁₅ N	0.726	1123	4.47
Triethylene glycol	C ₆ H ₁₄ O ₄	1.123	1608	3.8
1,1,1-Trifluoro-2-Chloro-2-Bromo-Ethane	C ₂ HClBrF ₃	1.869	693	
1,2,2-Trifluorotrichloro- ethane (Freon 113)	CCl ₂ F-CClF ₂	1.563	783.7	3.44
d-1,3,3-Trimethylnor- camphor	C ₁₀ H ₁₆ O	0.947	1320	
Trinitrotoluene	C ₇ H ₅ (NO ₂) ₃	1.64	1610	
Turpentine		0.88	1255	
Unisis 800		0.87	1346	
Water, distilled	H ₂ O	0.996	1498	-2.4
Water, heavy	D ₂ O		1400	
Water, sea		1.025	1531	-2.4
Wood Alcohol	CH ₄ O	0.791 (20°C)	1076	2.92
Xenon	Xe		630	
m-Xylene	C ₈ H ₁₀	0.868 (15°C)	1343	
o-Xylene	C ₈ H ₁₀	0.897 (20°C)	1331.5	4.1
p-Xylene	C ₈ H ₁₀		1334	
Xylene hexafluoride	C ₈ H ₄ F ₆	1.37	879	
Zinc	Zn		3298	

6.10 Solid sound speeds

1. Use Shear Wave for “A” & “B” Transducers

2. Use Long Wave for “C” & “D” Transducers

Material	Shear Wave m/s	Long Wave m/s
Steel 1% Carbon (hardened)	3150	5880
Carbon Steel	3230	5890
Mild Steel	3235	5890
Steel 1% Carbon	3220	
302 - Stainless Steel	3120	5660
303 - Stainless Steel	3120	5660
304 - Stainless Steel	3075	
316 - Stainless Steel	3175	5310
347 - Stainless Steel	3100	5740
410 - Stainless Steel	2990	5390
430 - Stainless Steel	3360	
Aluminium	3100	6320
Aluminium (rolled)	3040	
Copper	2260	4660
Copper (annealed)	2325	
Copper (rolled)	2270	
CuNi (70%Cu, 30%Ni)	2540	5030
CuNi (90%Cu, 10%Ni)	2060	4010
Brass (Naval)	2120	4430
Gold (hard-drawn)	1200	3240
Inconel	3020	5820
Iron (electrolytic)	3240	5900
Iron (Armco)	3240	5900
Ductile Iron	3000	4550
Cast Iron	2500	
Monel	2720	5350
Nickel	2960	5630
Tin (rolled)	1670	3320
Titanium	3125	6100
Tungsten (annealed)	2890	5180
Tungsten (drawn)	2640	
Tungsten (carbide)	3980	
Zinc (rolled)	2440	4170
Glass (Pyrex)	3280	5610
Glass (heavy silicate flint)	2380	
Glass (light borate crown)	2840	5260
Nylon	1150	2400
Nylon (6-6)	1070	
Polyethylene (HD)		2310
Polyethylene (LD)	540	1940
PVC, cPVC		2400
Acrylic	1430	2730
Asbestos Cement		2200
Tar Epoxy		2000
Rubber		1900

7. TECHNICAL DATA

ENCLOSURE:

IP65 Protection Class Material	High Density P.U. Foam
Weight	< 1.5 Kg
Dimensions	275 x 150 x 55 mm
Connections	IP65 Protection Class

SUPPLY VOLTAGE:

	90 – 257 V AC, 50/60 Hz
Max. power consumption	9 Watts

BATTERY PACK:

Rechargeable	15 hrs Charge Time 24 hrs Operating Time Low Battery Indication on Display
--------------	--

KEYPAD:

Screened 16 Key Tactile Membrane Type

DISPLAY:

Graphic Display with Back Lighting	
Temperature Range	Operating -0°C to +60°C Storage -25°C to +60°C
	Max. Humidity at 40°C 85%

OUTPUTS:

Display	Volumetric Flow Flow Velocity Flow Rate (4 Significant Figures) Total Flow (12 Digits) Continuous Battery Level Indication Continuous Signal Level Indication ERROR messages	m ³ , Liters, Gallons, US Gallons Metres/sec, feet/sec, m ³ /hr, m ³ /s, m ³ /hr, m ³ /min, m ³ /s, liter/min, gallons/min, kgallon/min, Usgallon/hr Forward and Reverse
Analogue	0 - 20mA / 4 – 20 mA / 0 – 16 mA into 750 Ω	User Definable Scaling
Serial	Resolution RS232-C	0.1% of full scale inc. Handshaking User Definable Scaling
Pulse	5 Volts 1 or 100 Pulse(s) per second	User Definable scaling

DATA LOGGER:

Output Logs	Memory Capacity Via RS232 or displayed Graphically Application Details Flow Details	112K Bytes (53000 readings) and 20 different site set-up's
-------------	--	--

TRANSDUCERS

	Frequency	Velocity Range
“A” 13 mm pipe	2 MHz sensors	0.2 m/sec to 7 m/sec
“A” 89 mm pipe	2 MHz sensors	0.03 m/sec to 3,75 m/sec
“B” 90 mm pipe	1 MHz sensors	0.06 m/sec to 6,75 m/sec
“B” 1000 mm pipe	1 MHz sensors	0.02 m/sec to 1.25 m/sec
“C” 300 mm pipe	1 MHz High velocity sensors	0.06 m/sec to 6 m/sec
“C” 2000 mm pipe	1 MHz High velocity sensors	0.02 m/sec to 1,7 m/sec
“D” 1000 mm pipe	0.5 MHz sensors	0.04 m/sec to 3,45 m/sec
“D” 5000 mm pipe	0.5 MHz sensors	0.014 m/sec to 1,36 m/sec

Note: On some applications transducers can be used outside their normal pipe range.

- : Transducer sets “A” and “B” are standard.
- : Transducer sets “C” and “D” are optional.
- : A magnetic assembly is available for the Diagonal and “B” guide rail.

Standard (A,B and C)	Temperature range	-20°C to +100°C
Option (A,B and C)	Temperature range	-20°C to +200°C

ACCURACY:

+/- 2% for velocity ≥ 1 m/sec
0.02 m/sec for velocity < 1 m/sec

8. CE MARKING

The UFM 610 P has been tested and found to conform to EN50081 - 1 Emission Standards and EN50082 - 1 Immunity Standards. The tests were conducted by AQL - EMC Ltd, of 16 Cobham Road, Ferndown Industrial Estate, Wimborne, U.K. BH21 7PG. The unit was tested with all cables as supplied of a maximum length of 3m. While the operation of the unit may not be affected by the use of longer cables, KROHNE can make no statement about conformance to the above standards when these cables are in use.

The UFM 610 P is supplied with an external battery-charging unit. This unit is manufactured by Friemann & Wolf, Geratebau GmbH. P.O. Box 1164 D-48342 Ostbevern, Germany who have CE marked the equipment. KROHNE have purchased this equipment on the understanding that the manufacturers have tested the unit to the relevant standards prior to CE marking the product. KROHNE have not tested the charger unit and cannot accept responsibility for any non-conformance from the relevant standards.

9. WARRANTY

The ultrasonic flowmeter UFM 610 P is designed solely for measuring the volumetric flowrate of process products.

This flowmeter is not certified for use in hazardous areas.

Responsibility as to suitability and intended use of this flowmeter rests solely with the operator.

Improper installation and operation of the flowmeters (systems) may lead to loss of warranty.

In addition, the "General conditions of sale" forming the basis of the purchase contract are applicable.

If flowmeters need to be returned to KROHNE, please note the information given on the last-but-one page of these instructions. KROHNE regrets that it cannot repair or check your flowmeter(s) unless accompanied by the completed form sheet.

Document Number: 7.30854.32.00

Updated: January 1999

Software Version: v2.00

