

Technical Information

Dosimag

Electromagnetic flowmeter

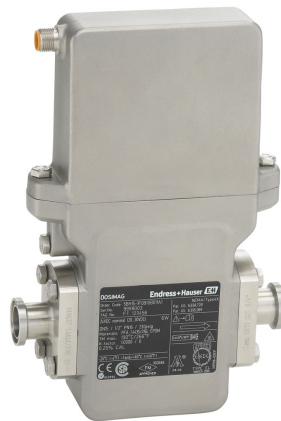

Flowmeter with maximum repeatability and ultra-compact sensor with hygienic design

Application

- The measuring principle is practically independent of pressure, density, temperature and viscosity
- For demanding batching and dosing applications

Device properties

- Wetted materials suitable for CIP/SIP cleaning
- Nominal diameter: DN 4 to 25 ($\frac{1}{8}$ to 1")
- FDA-compliant measuring device
- Pulse/frequency/switch output, Modbus RS485
- ATEX, cCSAus
- Excellent and easy-to-clean transmitter

Your benefits

- High process safety – high measuring accuracy and repeatability in shortest filling time
- Energy-saving flow measurement – no pressure loss due to cross-section constriction
- Maintenance-free – no moving parts
- Versatile and time-saving wiring – plug connector
- Industry-optimized – ultra-compact design
- For hygiene requirements – stainless steel housing







Table of contents

Document information	3	Process	25
Symbols used	3	Medium temperature range	25
Function and system design	4	Conductivity	26
Measuring principle	4	Pressure-temperature ratings	26
Measuring system	4	Pressure tightness	26
Equipment architecture	4	Flow limit	26
Safety	6	Pressure loss	26
Input	6	System pressure	26
Measured variable	6	Vibrations	27
Measuring range	6	Mechanical construction	27
Operable flow range	7	Dimensions in SI units	27
Input signal	7	Dimensions in US units	33
Output	7	Weight	38
Output signal	7	Materials	38
Signal on alarm	8	Fitted electrodes	39
Low flow cut off	9	Process connections	39
Galvanic isolation	9	Surface roughness	39
Protocol-specific data	9	Operability	39
Power supply	10	Local operation	39
Terminal assignment	10	Remote operation	39
Pin assignment, device plug	11	Certificates and approvals	40
Supply voltage	15	CE mark	40
Power consumption	16	C-Tick symbol	40
Current consumption	16	Ex approval	40
Power supply failure	16	Sanitary compatibility	40
Electrical connection	16	Pressure Equipment Directive	41
Potential equalization	17	Measuring instrument approval	41
Cable specification	17	Other standards and guidelines	41
Performance characteristics	18	Ordering information	41
Reference operating conditions	18	Accessories	41
Maximum measured error	19	Device-specific accessories	42
Repeatability	19	Communication-specific accessories	42
Influence of ambient temperature	19	Service-specific accessories	42
Installation	19	Supplementary documentation	43
Mounting location	20	Standard documentation	43
Orientation	20	Supplementary device-dependent documentation	43
Inlet and outlet runs	22	Registered trademarks	44
Adapters	22		
Special mounting instructions	23		
Environment	24		
Ambient temperature range	24		
Storage temperature	24		
Degree of protection	25		
Shock resistance	25		
Vibration resistance	25		
Interior cleaning	25		
Electromagnetic compatibility (EMC)	25		









Document information

Symbols used





Electrical symbols

Symbol	Meaning
	Direct current
	Alternating current
	Direct current and alternating current
	Ground connection A grounded terminal which, as far as the operator is concerned, is grounded via a grounding system.
	Protective ground connection A terminal which must be connected to ground prior to establishing any other connections.
	Equipotential connection A connection that has to be connected to the plant grounding system: This may be a potential equalization line or a star grounding system depending on national or company codes of practice.

Symbols for certain types of information

Symbol	Meaning
	Permitted Procedures, processes or actions that are permitted.
	Preferred Procedures, processes or actions that are preferred.
	Forbidden Procedures, processes or actions that are forbidden.
	Tip Indicates additional information.
	Reference to documentation
	Reference to page
	Reference to graphic
	Visual inspection

Symbols in graphics

Symbol	Meaning
1, 2, 3,...	Item numbers
	Series of steps
A, B, C, ...	Views
A-A, B-B, C-C, ...	Sections
	Hazardous area
	Safe area (non-hazardous area)
	Flow direction

Function and system design

Measuring principle

Following *Faraday's law of magnetic induction*, a voltage is induced in a conductor moving through a magnetic field.

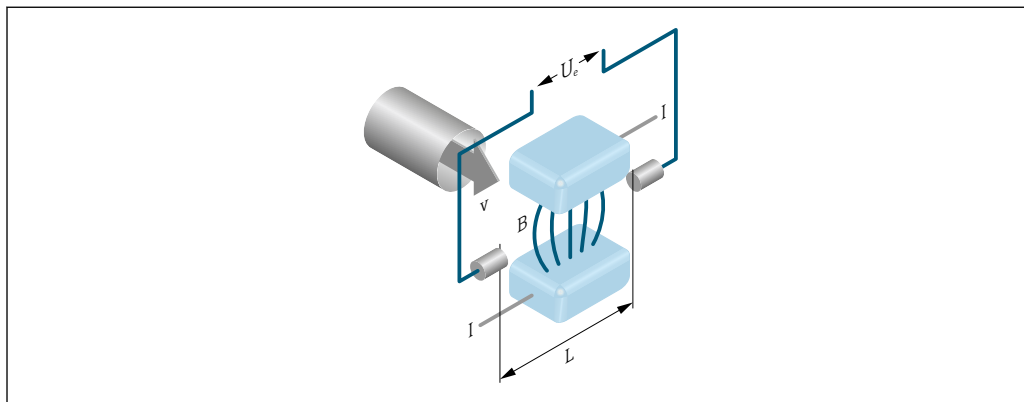

A0028962

- U_e Induced voltage
- B Magnetic induction (magnetic field)
- L Electrode spacing
- I Current
- v Flow velocity

In the electromagnetic measuring principle, the flowing medium is the moving conductor. The voltage induced (U_e) is proportional to the flow velocity (v) and is supplied to the amplifier by means of two measuring electrodes. The flow volume (Q) is calculated via the pipe cross-section (A). The DC magnetic field is created through a switched direct current of alternating polarity.

Formulae for calculation

- Induced voltage $U_e = B \cdot L \cdot v$
- Volume flow $Q = A \cdot v$

Measuring system

The device consists of a transmitter and a sensor.

The device is available as a compact version:

The transmitter and sensor form a mechanical unit.

<p>Dosimag</p> <p style="text-align: right; font-size: small;">A0023381</p>	<p>Transmitter</p> <ul style="list-style-type: none"> ■ Materials: <ul style="list-style-type: none"> - Transmitter housing: stainless steel 1.4308 (304) - Housing seal: EPDM ■ Configuration: <ul style="list-style-type: none"> Via operating tools (e.g. FieldCare) <p>Sensor</p> <ul style="list-style-type: none"> ■ Range of nominal diameter: DN 4 ($\frac{5}{32}$"), DN 8 ($\frac{3}{8}$"), 15 ($\frac{1}{2}$"), 25 (1") ■ Materials: <ul style="list-style-type: none"> - Sensor housing: stainless steel 1.4308 (304) - Measuring tube: stainless steel 1.4301 (304) - Liner: PFA - Process connection seals: EPDM, silicone, Viton - Electrodes: 1.4435 (316L); option Alloy C22, 2.4602 (UNS N06022), tantalum, platinum
--	---

Equipment architecture

Device version: Two pulse/frequency/switch outputs

The device version has two pulse/frequency/switch outputs → 10.

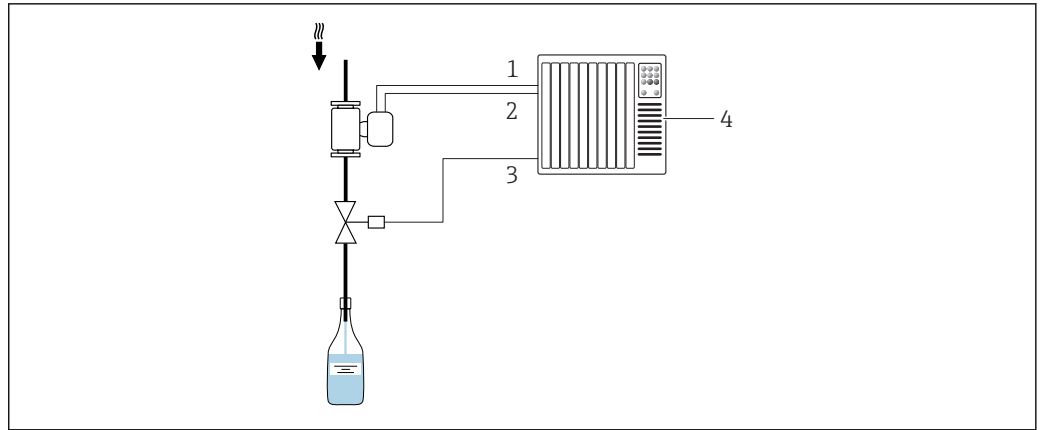

A0027057

1 Options for integration into a system for batching processes

- 1 Pulse/frequency/current output 1
- 2 Pulse/frequency/current output 2
- 3 Control of valve (by automation system)
- 4 Control system (e.g. PLC)

Device version: Modbus RS485, one or two switch outputs (Batch) and one status input

i Device versions with MODBUS RS485 have one or two switch outputs for valve control for the regulation of batching processes → **10**.

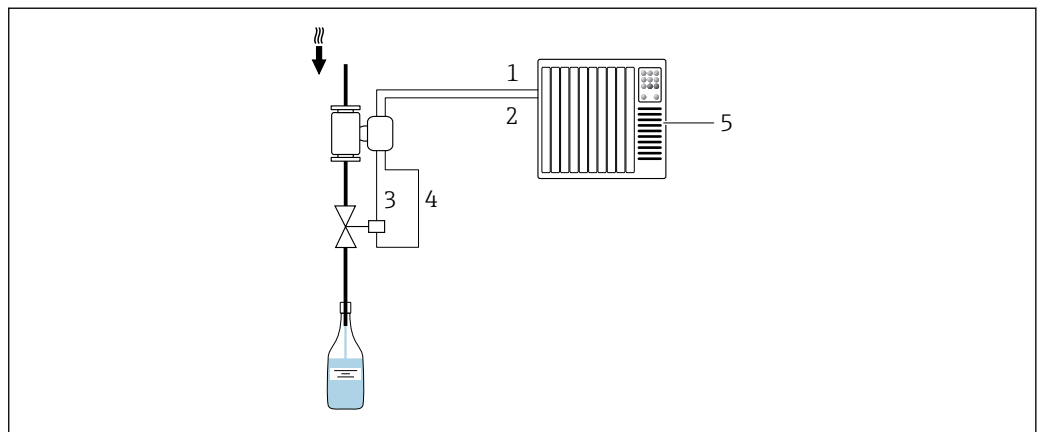

A0026621

2 Options for integration into a system for batching processes

- 1 MODBUS RS485: Measured value (to the automation system)
- 2 Status input: Control of batching process (by the automation system)
- 3 Switch output 1 (batch): valve control, level 1
- 4 Switch output 2 (batch): valve control, level 2
- 5 Control system (e.g. PLC)

Integrated batching functions

The following parameters can be used to configure and monitor batching processes.

Configuration

- Measured variable: volume flow
- Unit
- Batch quantity
- Fixed compensation quantity
- Select batch profile
- Drip correction mode: Off, low flow cut off or fixed time
- Measuring time drip quantity
- Filter depth drip median (3, 5 or 7)
- Average drip correction quantity
- Batch levels: One-level, two-level or one-level and blow out

- Start and stop level 2
- Blow out delay and duration
- Maximum batch time
- Maximum flow
- Disable time pressure shock suppression

Display

- Total amount measured from last batching process (incl. drip quantity)
- Duration of last batching process (incl. measurement of drip quantity)
- Switch-off time: From time of switch-off to when measurement of the drip quantity is complete
- Current drip correction quantity (drip correction quantity for next batching process)
- Sum of all batching processes measured
- Number of batching processes

 The batching process (start batch, stop batch etc.) is controlled by the automation system via the status input or the Modbus RS485 .

Safety

IT security

We only provide a warranty if the device is installed and used as described in the Operating Instructions. The device is equipped with security mechanisms to protect it against any inadvertent changes to the device settings.

IT security measures in line with operators' security standards and designed to provide additional protection for the device and device data transfer must be implemented by the operators themselves.

Input

Measured variable

Direct measured variables

Volume flow (proportional to induced voltage)

Measuring range

Typically $v = 0.01$ to 10 m/s (0.03 to 33 ft/s) with specified accuracy

Flow characteristic values in SI units

Nominal diameter	Recommended flow	Factory settings	
		Pulse value	Low flow cut off ($v \sim 0.04$ m/s)
[mm]	Max. full scale value [l/s]	[ml]	[ml/s]
4	0.14	0.005	0.5
8	0.5	0.02	2
15K ¹⁾	1.2	0.1	7
15	1.66	0.1	7
25	5	0.2	16



1) Conical version (corresponds to DN 12)

Flow characteristic values in US units

Nominal diameter	Recommended flow	Factory settings	
		Pulse value	Low flow cut off ($v \sim 0.13$ ft/s)
[in]	Max. full scale value [gal/s]	[oz fl]	[oz fl/s]
$\frac{5}{32}$	0.035	0.0002	0.02
$\frac{5}{16}$	0.13	0.001	0.08

Nominal diameter [in]	Recommended flow Max. full scale value [gal/s]	Factory settings	
		Pulse value [oz fl]	Low flow cut off (v ~ 0.13 ft/s) [oz fl/s]
½K ¹⁾	0.32	0.004	0.25
½	0.44	0.004	0.25
1	1.33	0.007	0.53

1) Conical version (corresponds to DN 12)

 To calculate the measuring range, use the *Applicator* sizing tool →  42

Recommended measuring range

"Flow limit" section →  26

Operable flow range Over 1000 : 1

Input signal  Available only for device versions using the Modbus RS485 communication method →  10.

Status input

The batching process is controlled by the automation system via the device's status input.

Maximum input values	<ul style="list-style-type: none"> ▪ DC 30 V ▪ 6 mA
Response time	Adjustable: 10 to 200 ms
Input signal level	<ul style="list-style-type: none"> ▪ Low level: 0 to 1.5 V ▪ High level: 3 to 30 V
Assignable functions	<ul style="list-style-type: none"> ▪ Off ▪ Start batching process ▪ Start and stop batching process ▪ Reset totalizers 1-3 separately ▪ Reset all totalizers ▪ Flow override

Output

Output signal Pulse/frequency/switch output



Function	Can be set to: <ul style="list-style-type: none"> ▪ Pulse Quantity-proportional pulse with pulse width to be configured. ▪ Automatic pulse Quantity-proportional pulse with on/off ratio of 1:1 ▪ Frequency Flow-proportional frequency output with on/off ratio of 1:1 ▪ Switch Contact for displaying a status
Channel 2	Redundant output of pulse output: 0°, 90° or 180°
Version	Passive, open emitter
Maximum input values	<ul style="list-style-type: none"> ▪ DC 30 V ▪ 25 mA

Voltage drop	At 25 mA: ≤ DC 2 V
Pulse output	
Pulse width	Adjustable: 0.05 to 3.75 ms
Maximum pulse rate	10 000 Impulse/s
Pulse value	Adjustable
Assignable measured variables	Volume flow
Frequency output	
Output frequency	Adjustable: 0 to 10 000 Hz
Damping	Adjustable: 0 to 999.9 s
Pulse/pause ratio	1:1
Assignable measured variables	Volume flow
Switch output	
Switching behavior	Binary, conductive or non-conductive
Number of switching cycles	Unlimited
Assignable functions	<ul style="list-style-type: none"> ▪ Off ▪ On ▪ Diagnostic behavior <ul style="list-style-type: none"> - Alarm - Alarm and warning - Warning ▪ Limit value: <ul style="list-style-type: none"> - Off - Volume flow - Flow velocity ▪ Status <ul style="list-style-type: none"> Low flow cut off

Modbus RS485

Physical interface	In accordance with EIA/TIA-485-A standard
--------------------	---

Switch output (batch: valve control)

-  Only available for device version with Modbus RS485 →  10.
- Depending on the device version, the device has one or two switch outputs.

Switch output	
Version	Active, open emitter
Maximum input values	<ul style="list-style-type: none"> ▪ DC 30 V ▪ 500 mA
Switching behavior	Binary, conductive or non-conductive
Number of switching cycles	Unlimited
Assignable functions	<ul style="list-style-type: none"> ▪ Open ▪ Closed ▪ Batching

Signal on alarm

Depending on the interface, failure information is displayed as follows:

Pulse/frequency/switch output

Pulse output

Failure mode	Choose from: <ul style="list-style-type: none"> ▪ Actual value ▪ No pulses
---------------------	--

Frequency output

Failure mode	Choose from: <ul style="list-style-type: none"> ▪ Actual value ▪ 0 Hz ▪ Defined value: 0 to 10 000 Hz
---------------------	--

Switch output

Failure mode	Choose from: <ul style="list-style-type: none"> ▪ Current status ▪ Open ▪ Closed
---------------------	---

Modbus RS485

Failure mode	Choose from: <ul style="list-style-type: none"> ▪ NaN value instead of current value ▪ Last valid value
---------------------	---

Low flow cut off

The switch points for low flow cut off are user-selectable.



Galvanic isolation

- Device version: 2 pulse/frequency/switch outputs
Order code for "Output, input", option 3:
 - Pulse/frequency/switch outputs galvanically isolated from supply potential.
 - Pulse/frequency/switch outputs not galvanically isolated from each other.
- Device version: Modbus RS485, 1 switch output (batch), 1 status input
(Order code for "Output, input": option 4)
Switch outputs (batch) and status input on supply potential
- Device version: Modbus RS485, 2 switch outputs (batch), 1 status input
(Order code for "Output, input", option 5:)
– Switch outputs (batch) on supply potential.
– Status input, galvanically isolated.

Protocol-specific data

Modbus RS485

Protocol	Modbus Applications Protocol Specification V1.1
Device type	Slave
Slave address range	1 to 247
Broadcast address range	0
Function codes	<ul style="list-style-type: none"> ▪ 03: Read holding register ▪ 04: Read input register ▪ 06: Write single registers ▪ 08: Diagnostics ▪ 16: Write multiple registers ▪ 23: Read/write multiple registers ▪ 43: Read device identification
Broadcast messages	Supported by the following function codes: <ul style="list-style-type: none"> ▪ 06: Write single registers ▪ 16: Write multiple registers ▪ 23: Read/write multiple registers





Supported baud rate	<ul style="list-style-type: none"> ▪ 1 200 BAUD ▪ 2 400 BAUD ▪ 4 800 BAUD ▪ 9 600 BAUD ▪ 19 200 BAUD ▪ 38 400 BAUD ▪ 57 600 BAUD ▪ 115 200 BAUD
Data transfer mode	<ul style="list-style-type: none"> ▪ ASCII ▪ RTU
Data access	<p>Each device parameter can be accessed via Modbus RS485.</p> <p> For Modbus register information →  43</p>

Power supply

Terminal assignment

Connection is solely by means of device plug:

There are different device versions available:

Order code for "Output, input":	Device plug
Option 3: 2 pulse/frequency/switch outputs ¹⁾	→  11
Option 4: Modbus RS485, 1 switch output (batch), 1 status input	→  12
Option 5: Modbus RS485, 2 switch outputs (batch), 1 status input	→  13
Option 6: Modbus RS485 (custody transfer mode)	→  15

1) Can also be used for custody transfer mode.

Pin assignment, device plug

Device version: 2 pulse/frequency/switch outputs

Order code for "Output, input", option 3:
 2 Pulse/frequency/switch output

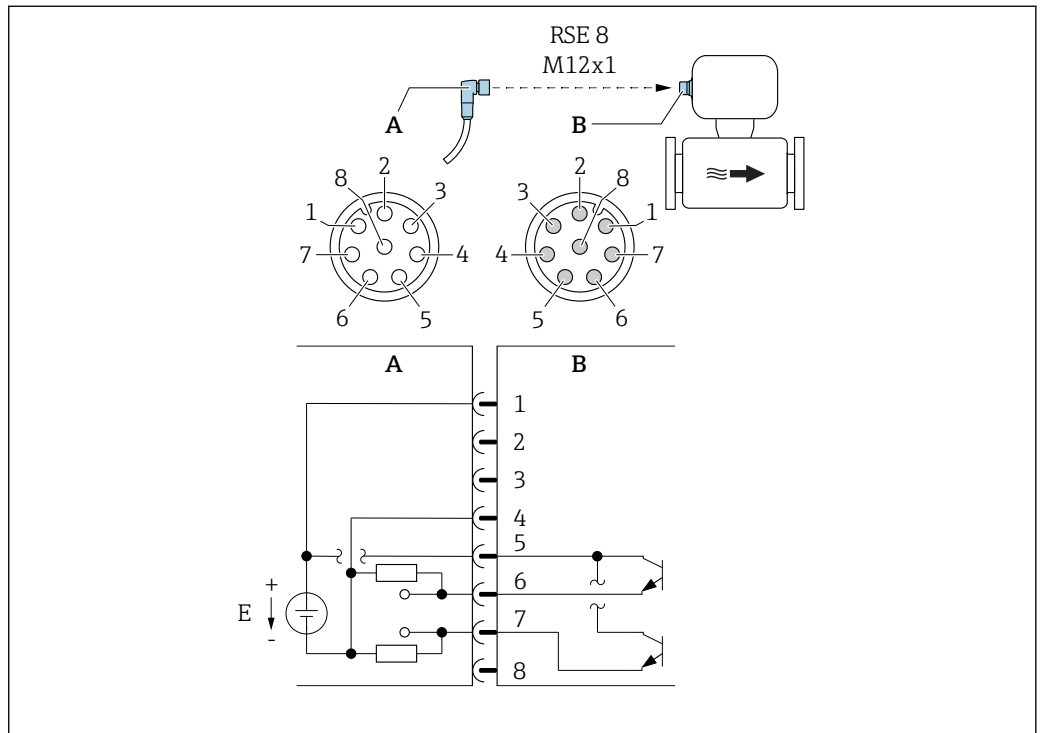

A0032569

3 Connection to device

- A Coupling: Supply voltage, pulse/freq./switch output
- B Connector: Supply voltage, pulse/freq./switch output
- E PELV or SELV power supply
- 1 to Pin assignment
- 8

Pin assignment

Connection: Coupling (A) – Connector (B)		
Pin	Assignment	
1	L+	Supply voltage
2	+	Service interface RX
3	+	Service interface TX
4	L-	Supply voltage
5	+	Pulse/frequency/switch output
6	-	Pulse/frequency/switch output 1
7	-	Pulse/frequency/switch output 2
8	-	Service interface GND

i Observe cable specifications → 17.

Device version: Modbus RS485, status output and status input

Order code for "Output, input", option 4:

- Modbus RS485
- 1 switch output (batch)
- 1 status input

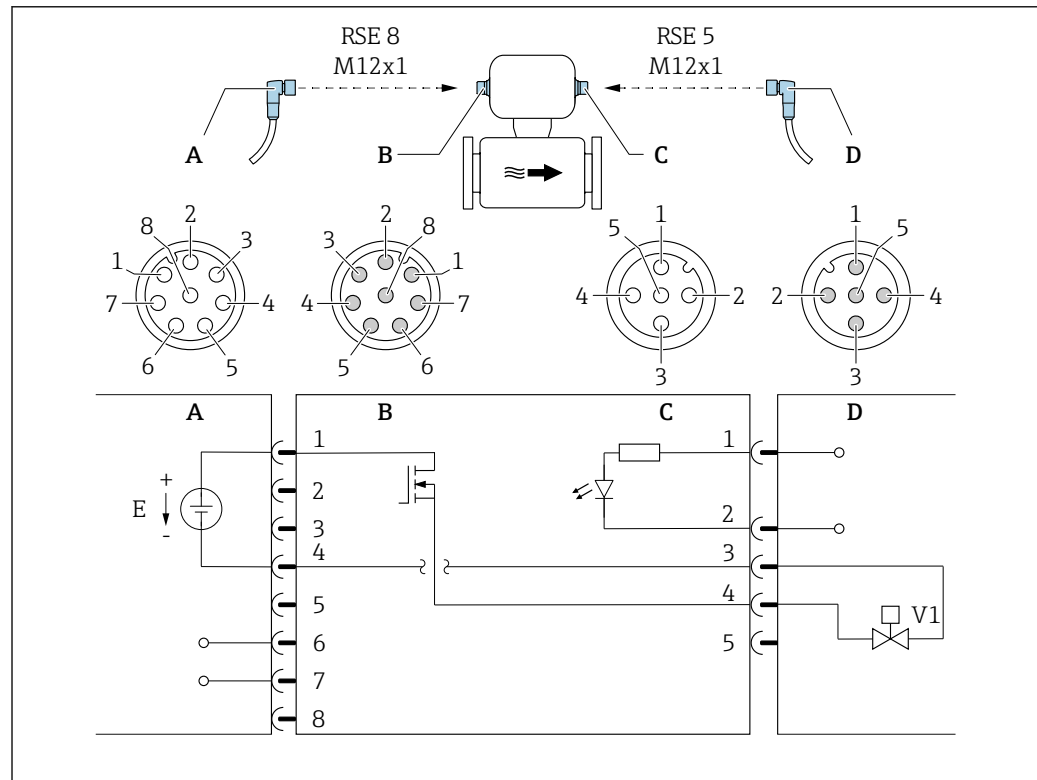

A0032570

4 Connection to device

- A Coupling: Supply voltage, Modbus RS485
- B Connector: Supply voltage, Modbus RS485
- C Coupling: Switch output (batch), status input
- D Connector: Switch output (batch), status input
- E PELV or SELV power supply
- V1 Valve 1 (batch)
- 1 to Pin assignment
- 8

Pin assignment

Connection: Coupling (A) – Connector (B)			Connection: Coupling (C) – Connector (D)		
Pin	Assignment		Pin	Assignment	
1	L+	Supply voltage	1	+	Status input
2	+	Service interface RX	2	-	Status input
3	+	Service interface TX	3	-	Switch output (batch)
4	L-	Supply voltage	4	+	Switch output (batch)
5	Not assigned		5	Not assigned	
6	A	Modbus RS485			
7	B	Modbus RS485			
8	-	Service interface GND			

Observe cable specifications → 17.

Device version: Modbus RS485 , 2 status outputs and status input

Order code for "Output, input", option 5:

- Modbus RS485
- 2 switch outputs (batch)
- 1 status input

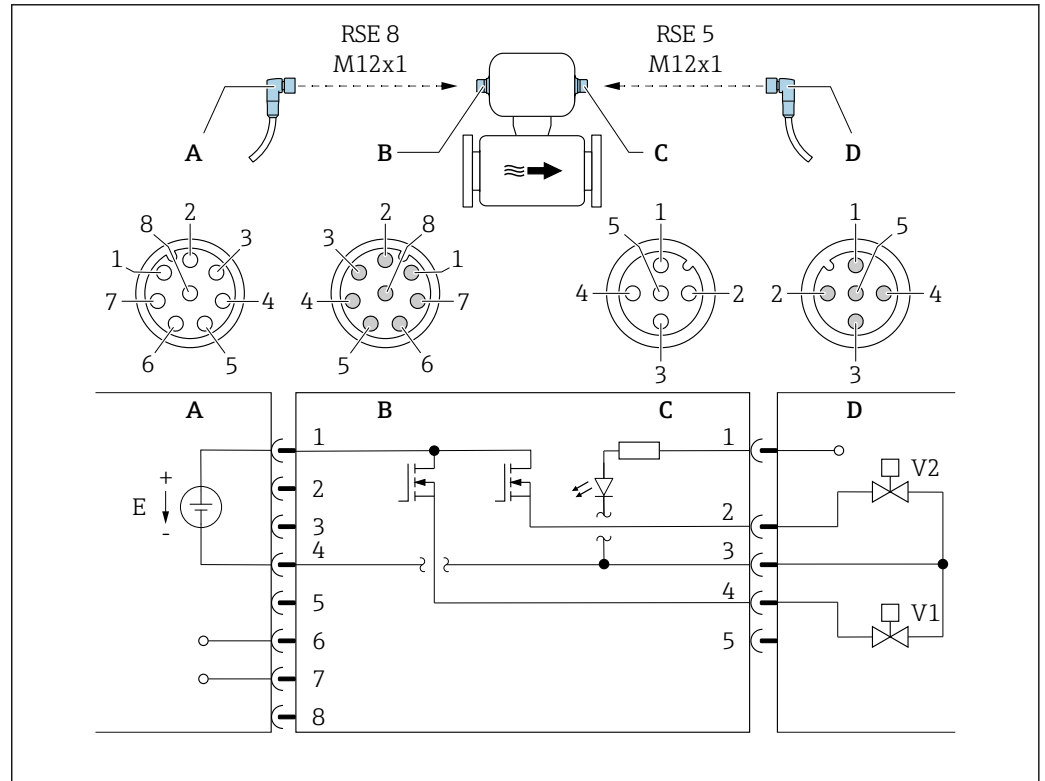

A0032571



5 Connection to device

- A Coupling: Supply voltage, Modbus RS485
- B Connector: Supply voltage, Modbus RS485
- C Coupling: Switch outputs (batch), status input
- D Connector: Switch outputs (batch), status input
- E PELV or SELV power supply
- V1 Valve (batch), level 1
- V2 Valve (batch), level 2
- 1 to Pin assignment
- 8

Pin assignment

Connection: Coupling (A) – Connector (B)			Connection: Coupling (C) – Connector (D)		
Pin	Assignment		Pin	Assignment	
1	L+	Supply voltage	1	+	Status input
2	+	Service interface RX	2	+	Switch output (batch) 2
3	+	Service interface TX	3	-	Switch outputs, status input
4	L-	Supply voltage	4	+	Switch output (batch) 1
5	Not assigned		5	Not assigned	
6	A	Modbus RS485			

Connection: Coupling (A) – Connector (B)			Connection: Coupling (C) – Connector (D)	
Pin	Assignment		Pin	Assignment
7	B	Modbus RS485		
8	–	Service interface GND		

 Observe cable specifications →  17.

Device version: Modbus RS485 (custody transfer mode)

Order code for "Output, input", option 6 (device version for custody transfer mode):
Modbus RS485

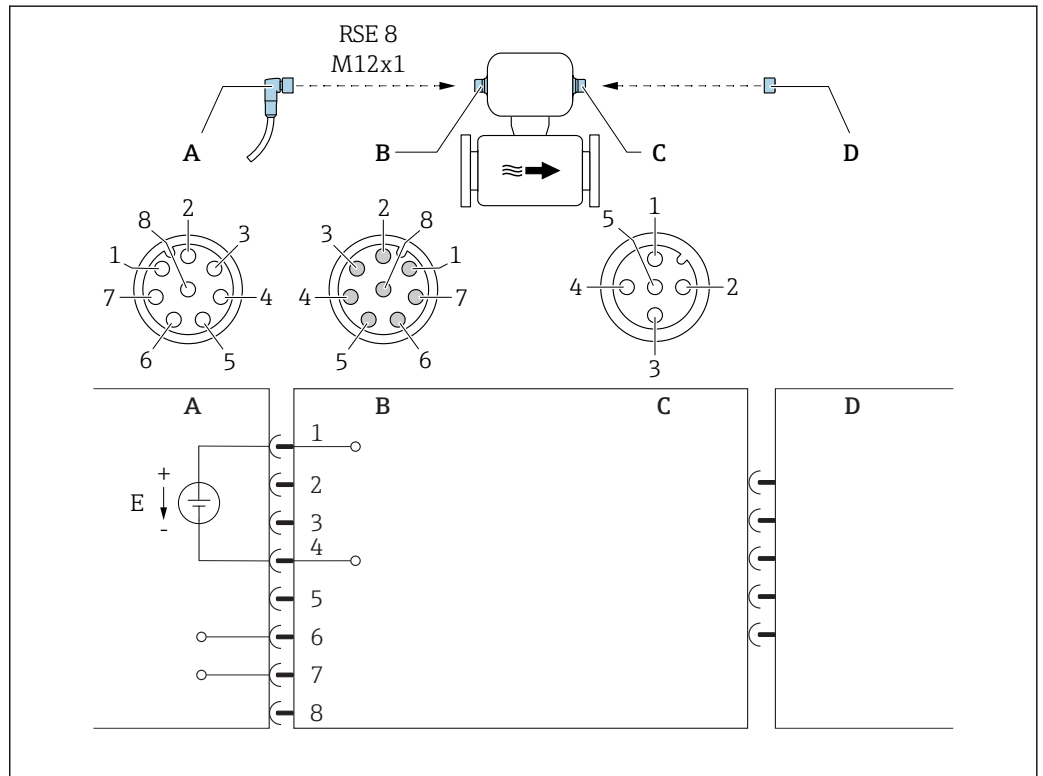

A0032572

6 Connection to device

- A Coupling: Supply voltage, Modbus RS485
- B Connector: Supply voltage, Modbus RS485
- C Coupling at device
- D Connector: Dongle (hardware write protection for custody transfer mode)
- E PELV or SELV power supply

Pin assignment

Connection: Coupling (A) – Connector (B)			Connection: Coupling (C) – Connector (D)	
Pin	Assignment		Pin	Assignment
1	L+	Supply voltage	1	NC
2	+	Service interface RX	2	NC
3	+	Service interface TX	3	NC
4	L-	Supply voltage	4	+
5	Not assigned		5	-
6	A	Modbus RS485		
7	B	Modbus RS485		
8	-	Service interface GND		

Observe cable specifications → 17.

Supply voltage

DC 24 V (nominal voltage: DC 20 to 30 V)

- The power unit must be tested to ensure that it meets safety requirements (e.g. PELV, SELV).
- The supply voltage must not exceed a maximum short-circuit current of 50 A.

Power consumption 4.5 W

Current consumption

Order code for "Output, input":	Maximum Power consumption
Option 3: 2 pulse/frequency/switch outputs	225 mA
Option 4: Modbus RS485, 1 switch output (batch), 1 status input	225 mA + 500 mA ¹⁾
Option 5: Modbus RS485, 2 switch outputs (batch), 1 status input	225 mA + 1000 mA ¹⁾
Option 6: Modbus RS485 (custody transfer mode)	225 mA

1) Additional 500 mA per switch output (batch) used.

 Switch-on current: max. 1 A (< 8 ms)

Power supply failure

- Totalizers stop at the last value measured.
- Error messages (incl. total operated hours) are stored.

Electrical connection



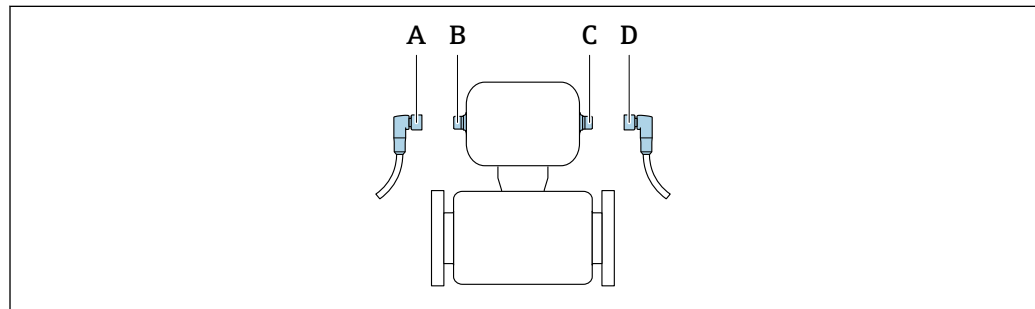

Connection is solely by means of device plug:



A0032534

A, C Coupling
B, D Plug

There are different device versions available:

Order code for "Output, input":	Device plug
Option 3: 2 pulse/frequency/switch outputs	→  11
Option 4: Modbus RS485, 1 switch output (batch), 1 status input	→  12
Option 5: Modbus RS485, 2 switch outputs (batch), 1 status input	→  13
Option 6: Modbus RS485 (custody transfer mode)	→  15

Grounding

Grounding is by means of a cable socket.

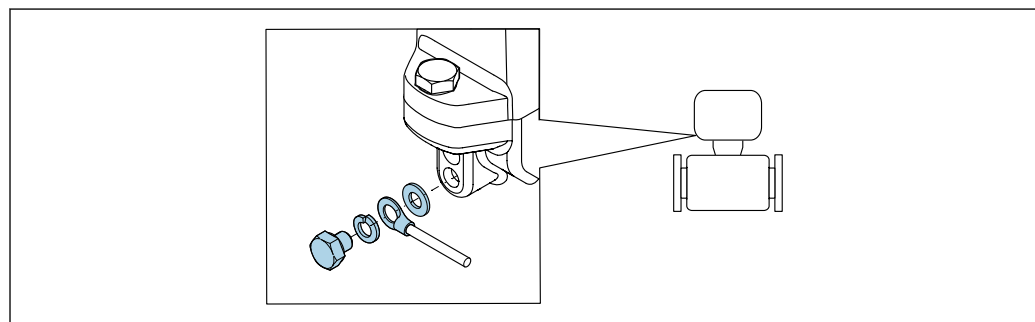

A0003838

Potential equalization

Requirements

No potential matching is needed for grounded steel lines.



For devices intended for use in hazardous locations, please observe the guidelines in the Ex documentation (XA).

Cable specification

Permitted temperature range

- -40 °C (-40 °F) to +80 °C (+176 °F)
- Minimum requirement: cable temperature range \geq ambient temperature +20 K

Signal cable



Cables are not included in the scope of delivery; they can be ordered as an accessory → 41.

Pulse/frequency/switch output

Standard installation cable is sufficient.

Status input and switch output (batch)

Standard installation cable is sufficient.

Modbus RS485



- The electrical connection of the shield to the device housing must be properly implemented (e.g. using a knurled nut).
- Please note the following with regard to cable loading:
 - Voltage drop due to the cable length and cable type.
 - Valve performance.

Total length of cable in the Modbus network \leq 50 m

Use a shielded cable.

Example:

Terminated device connector with cable: Lumberg RKWTH 8-299/10

Total length of cable in the Modbus network $>$ 50 m

Use shielded twisted pair cable for RS485 applications.

Example:

- Cable: Belden item no. 9842 (for 4-wire version, the same cable can be used for the power supply)
- Terminated device plug: Lumberg RKCS 8/9 (shieldable version)

RSE8 to RSE5 adapter



This adapter is not included in the scope of delivery. It is essential for custody transfer mode.

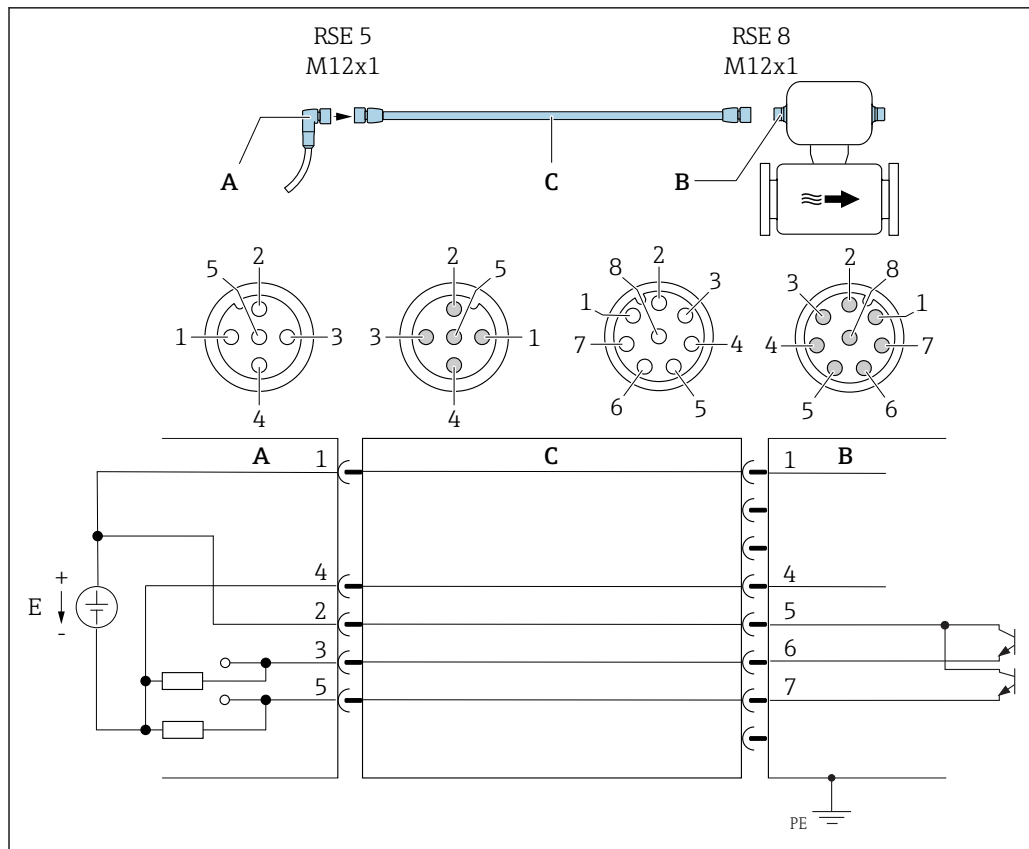

A0032840

7 Connection to device

- A Coupling
- B Plug
- C RSE8 to RSE5 adapter cable
- E PELV or SELV power supply

Pin assignment

Pin	Assignment	
1	+	Supply voltage
2	+	Pulse/frequency/switch output
3	-	Pulse/frequency/switch output
4	-	Supply voltage
5	-	Pulse/frequency/switch output

Performance characteristics



Reference operating conditions

In accordance with DIN EN 29104

- Medium temperature: $+28 \pm 2 \text{ }^\circ\text{C}$ ($+82 \pm 4 \text{ }^\circ\text{F}$)
- Ambient temperature: $+22 \pm 2 \text{ }^\circ\text{C}$ ($+72 \pm 4 \text{ }^\circ\text{F}$)
- Warm-up period: 30 min

Installation

- Inlet run $> 10 \times \text{DN}$
- Outlet run $> 5 \times \text{DN}$
- Sensor and transmitter grounded.
- The sensor is centered in the pipe.

 To calculate the measuring range, use the *Applicator* sizing tool →  42

Maximum measured error

Error limits under reference operating conditions

o.r. = of reading

Volume flow

- ±0.25 % o.r. ± 1 to 4 m/s (3.3 to 13 ft/s) or
- ±0.5 % o.r. ± 1 mm/s (0.04 in/s) or
- ±5 % o.r.

 Fluctuations in the supply voltage do not have any effect within the specified range.

Accuracy of outputs

 In the case of analog outputs, the output accuracy must also be considered for the measured error, in contrast, this need not be considered in the case of fieldbus outputs (Modbus RS485).

The outputs have the following base accuracy specifications.

Pulse/frequency output

o.r. = of reading

Accuracy	Max. ±50 ppm o.r. (across the entire ambient temperature range)
-----------------	---

Repeatability

o.r. = of reading

DN 25 (500 ml/s), DN 15 (200 ml/s), DN 8 (50 ml/s), DN 4 (10 ml/s); 400 µS/cm

Batch time t_a [s]	Relative standard deviation in relation to the batched volume [%]
1.5 s < t_a < 3 s	0.4
3 s < t_a < 5 s	0.2
5 s < t_a	0.1

DN 15K (200 ml/s); 400 µS/cm

Batch time t_a [s]	Relative standard deviation in relation to the batched volume [%]
1.5 s < t_a < 3 s	0.25
3 s < t_a < 5 s	0.12
5 s < t_a	0.08

Influence of ambient temperature

Pulse/frequency output

Temperature coefficient	No additional effect. Included in accuracy.
--------------------------------	---

Installation

No special measures such as supports etc. are necessary. External forces are absorbed by the construction of the device.

Mounting location

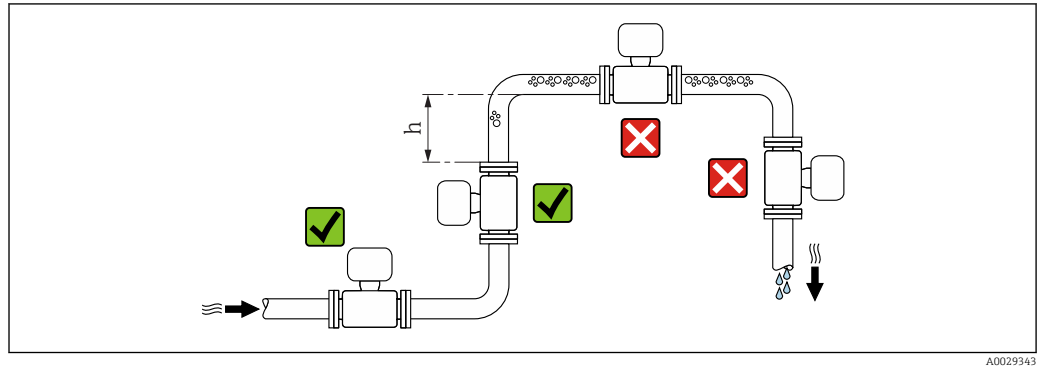

Preferably install the sensor in an ascending pipe, and ensure a sufficient distance to the next pipe elbow: $h \geq 2 \times DN$

Installation in down pipes

Install a siphon with a vent valve downstream of the sensor in down pipes whose length $h \geq 5 \text{ m}$ (16.4 ft). This precaution is to avoid low pressure and the consequent risk of damage to the measuring tube. This measure also prevents the system losing prime.

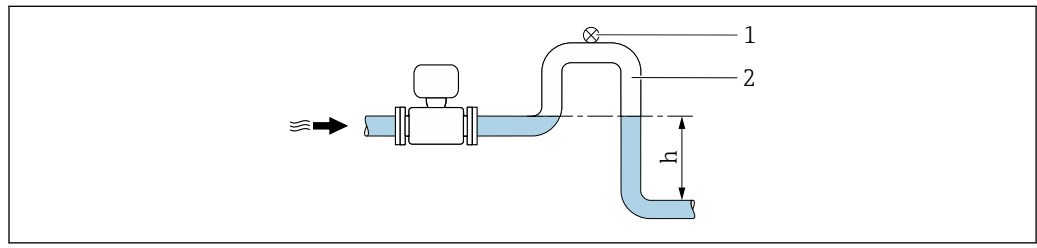

8 Installation in a down pipe

- 1 Vent valve
- 2 Pipe siphon
- h Length of down pipe

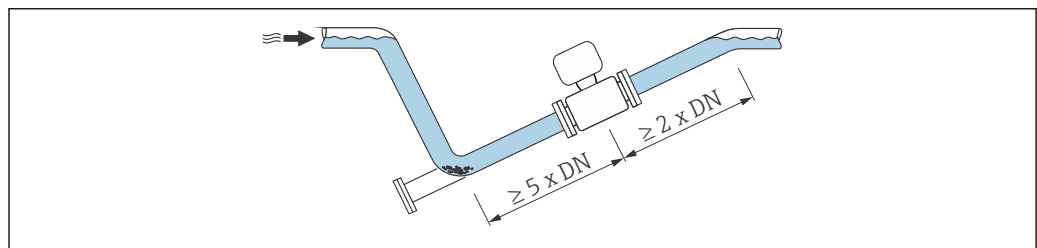

Installation in partially filled pipes

A partially filled pipe with a gradient necessitates a drain-type configuration.

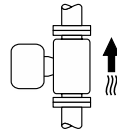
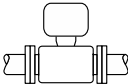
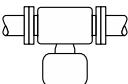

Orientation

The direction of the arrow on the sensor nameplate helps you to install the sensor according to the flow direction (direction of medium flow through the piping).

Orientation		Recommendation	
A	Vertical orientation	 A0015591	☑☑
B	Horizontal orientation, transmitter at top	 A0015589	☑☑ ¹⁾
C	Horizontal orientation, transmitter at bottom	 A0015590	☑☑ ^{2) 3)}
D	Horizontal orientation, transmitter at side	 A0015592	☒

- 1) Applications with low process temperatures may decrease the ambient temperature. To maintain the minimum ambient temperature for the transmitter, this orientation is recommended.
- 2) Applications with high process temperatures may increase the ambient temperature. To maintain the maximum ambient temperature for the transmitter, this orientation is recommended.
- 3) To prevent the electronics module from overheating in the case of a sharp rise in temperature (e.g. CIP- or SIP processes), install the device with the transmitter component pointing downwards.

Horizontal

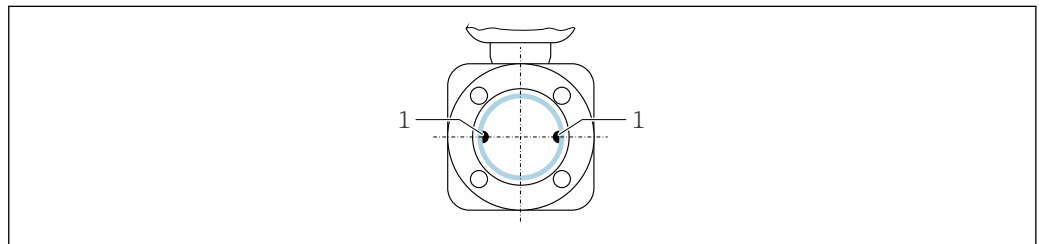

A0025817

1 Measuring electrodes for signal detection

 Ideally, the measuring electrode plane should be horizontal. This prevents brief insulation of the two measuring electrodes by entrained air bubbles.

Valves

Never install the sensor downstream from a filling valve. If the sensor is completely empty this corrupts the measured value.

 Correct measurement is only possible if the pipe is completely full. Perform sample fillings before commencing filling in production.

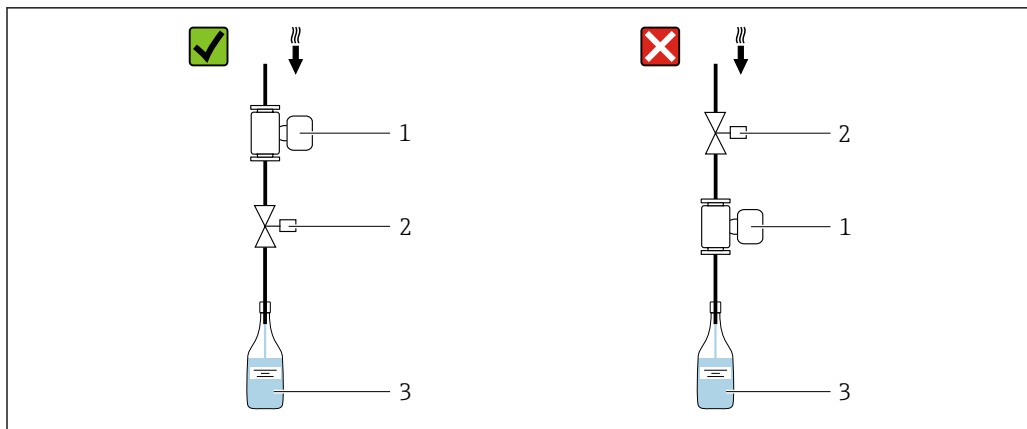

A0003768

- 1 Measuring device
- 2 Filling valve
- 3 Container

Filling systems

The pipe system must be completely full to ensure optimum measurement.

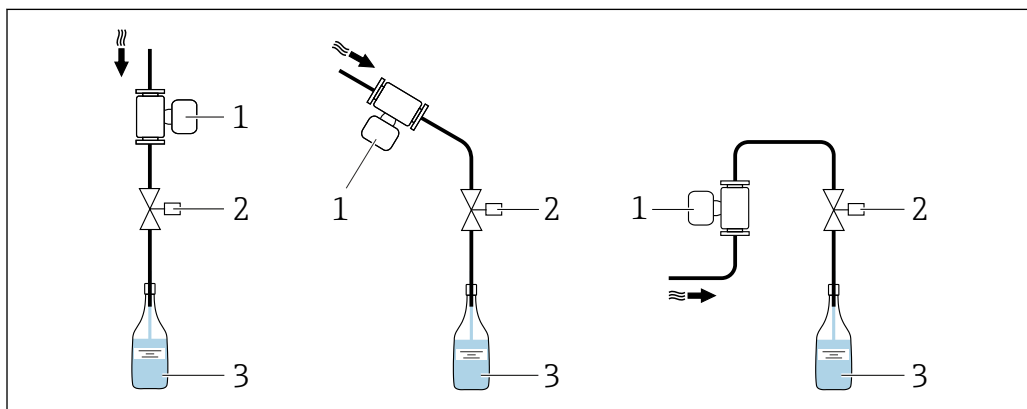

A0003795

9 Filling system

- 1 Measuring device
- 2 Filling valve
- 3 Container

Inlet and outlet runs

If possible, install the sensor upstream from fittings such as valves, T-pieces or elbows.

Observe the following inlet and outlet runs to comply with accuracy specifications:

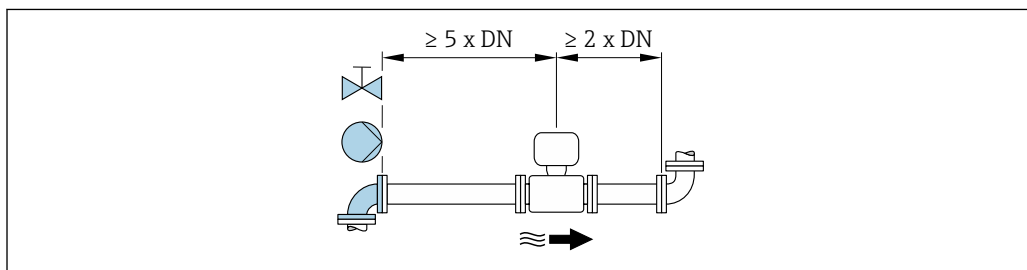

A0028997

Adapters

Suitable adapters to DIN EN 545 (double-flange reducers) can be used to install the sensor in larger-diameter pipes. The resultant increase in the rate of flow improves measuring accuracy with very slow-moving fluids.

The nomogram shown here can be used to calculate the pressure loss caused by reducers and expanders:

- Calculate the ratio of the diameters d/D .
- From the nomogram read off the pressure loss as a function of flow velocity (downstream from the reduction) and the d/D ratio.

 The nomogram only applies to liquids with a viscosity similar to that of water.

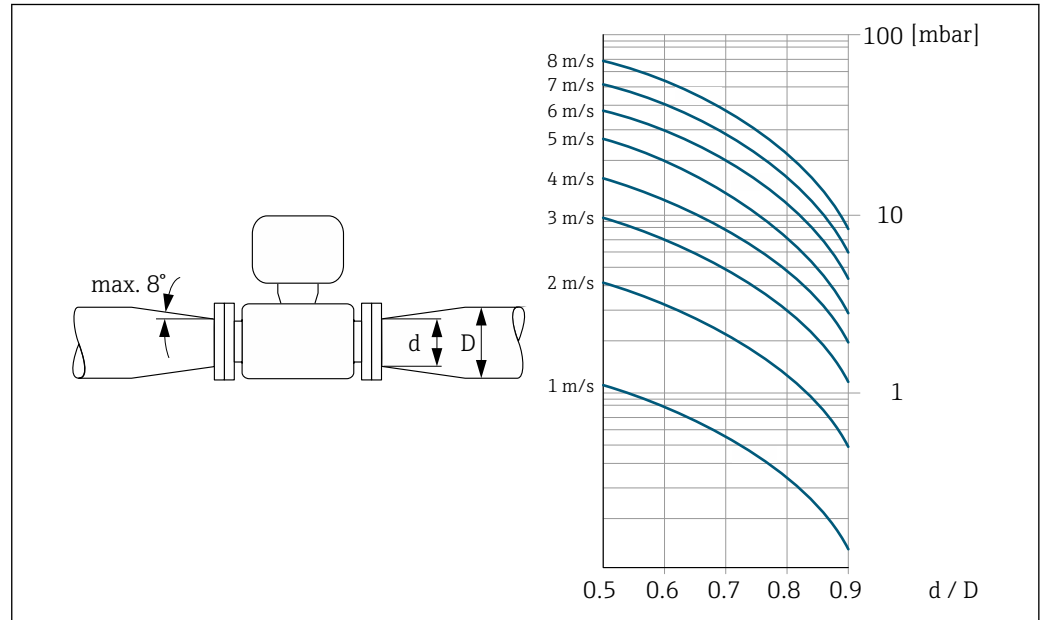

A0029002

Special mounting instructions

Information for filling systems

Correct measurement is possible only if the piping is completely filled. We therefore recommend that some test batches be carried out prior to production batching.

Circular filling system

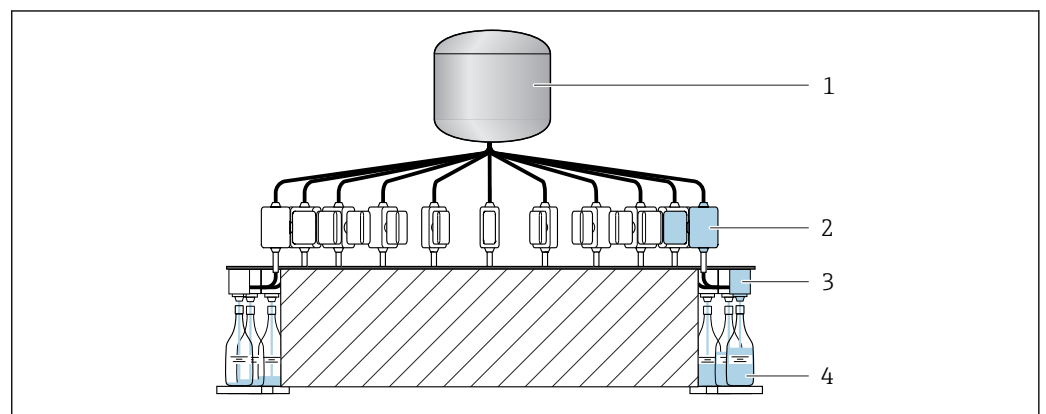

A0003761

- 1 Tank
- 2 Measuring device
- 3 Batching valve
- 4 Vessel

Linear filling system

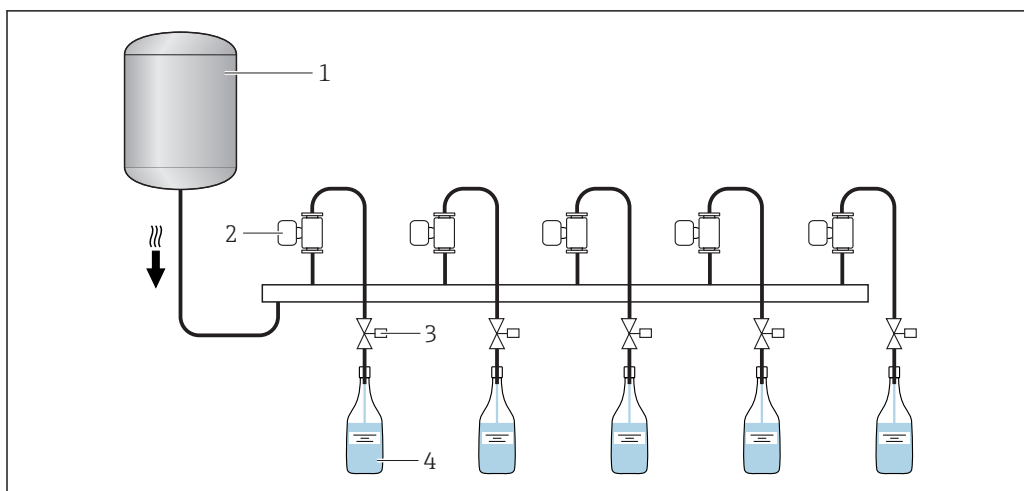

A0003762

- 1 Tank
- 2 Measuring device
- 3 Batching valve
- 4 Vessel

Environment

Ambient temperature range

Transmitter	-40 to +60 °C (-40 to +140 °F)
Sensor	-40 to +60 °C (-40 to +140 °F)

Temperature tables

The following interdependencies between the permitted ambient and fluid temperatures apply when operating the device in hazardous areas:

Ex nA

SI units

	T5 [100 °C]	T4 [135 °C]	T3 [200 °C]	T2 [300 °C]	T1 [450 °C]
Ambient temperature T_a	60	50	45	45	45
Maximum medium temperature T_m	70	105	130	130	130

US units

	T5 [212 °F]	T4 [275 °F]	T3 [392 °F]	T2 [572 °F]	T1 [842 °F]
Ambient temperature T_a	140	122	113	113	113
Maximum medium temperature T_m	158	221	266	266	266



The minimum temperature of the medium is -20 °C (-4 °F).

The minimum ambient temperature is -40 °C (-40 °F).

Storage temperature

The storage temperature corresponds to the ambient temperature range of the transmitter and sensor. → ☰ 24

- Protect the measuring device against direct sunlight during storage in order to avoid unacceptably high surface temperatures.
- Select a storage location where moisture cannot collect in the measuring device as fungus or bacteria infestation can damage the liner.
- If protection caps or protective covers are mounted these should never be removed before installing the measuring device.

Degree of protection	As standard: IP67, type 4X enclosure
Shock resistance	Acceleration up to 2 g based on IEC 60068-2-6
Vibration resistance	Acceleration up to 2 g based on IEC 60068-2-6
Interior cleaning	<ul style="list-style-type: none"> ▪ Cleaning in place (CIP) ▪ Sterilization in place (SIP) <p> Observe the maximum medium temperatures →  25</p>
Electromagnetic compatibility (EMC)	<p>According to IEC/EN 61326</p> <p> For details, refer to the Declaration of Conformity.</p>

Process

Medium temperature range	<p>Sensor -20 to +130 °C (-4 to +266 °F)</p> <p>Cleaning +150 °C (+302 °F) / 60 min for CIP and SIP processes</p> <p>Seals</p> <ul style="list-style-type: none"> ▪ EPDM: -20 to +130 °C (-4 to +266 °F) (max. +150 °C (302 °F) for cleaning) ▪ Silicon: -20 to +130 °C (-4 to +266 °F) ▪ Viton: 0 to +150 °C (+32 to +302 °F)
---------------------------------	--

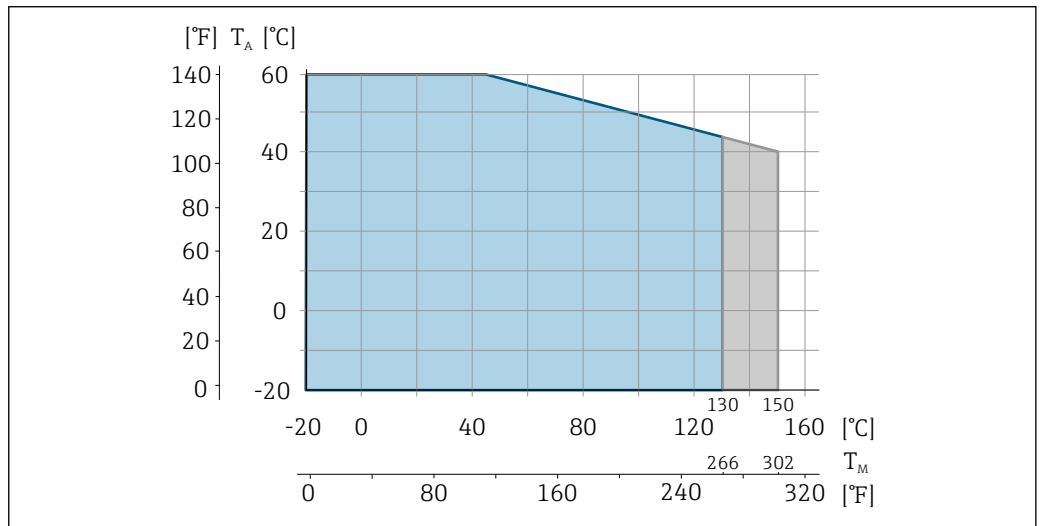

T_A Ambient temperature

T_M Medium temperature

Light-gray area: standard fluid temperature range

Dark-gray area: fluid temperature range for cleaning

- Conductivity**
- $\geq 5 \mu\text{S/cm}$ for liquids in general
 - $\geq 10 \mu\text{S/cm}$ for demineralized water

Pressure-temperature ratings Permitted process pressure: 16 bar (232 psi)

Process connection: Welded connection as per EN 10357 (DIN 11850), ODT/SMS; clamp L14 AM7

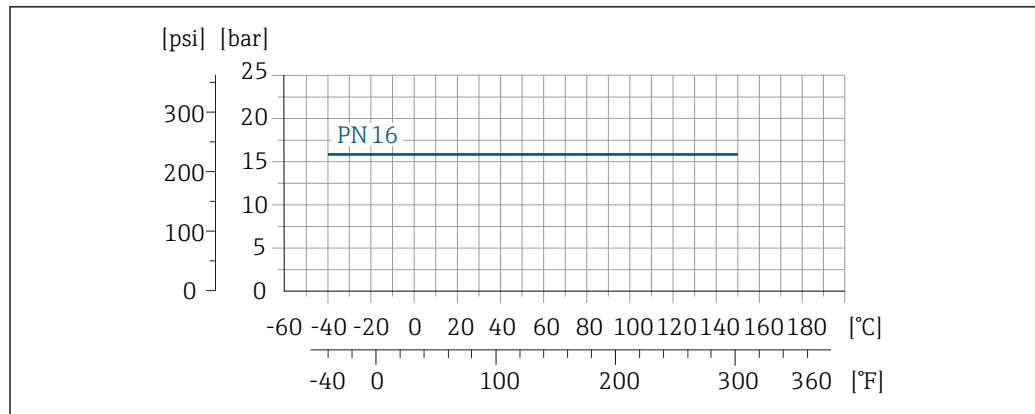

10 Process connection material: 1.4404 (316L) (with molded seal)

Pressure tightness Liner: PFA

Nominal diameter		Limit values for absolute pressure in [mbar] ([psi]) for fluid temperatures:	
[mm]	[in]	+25 °C (+77 °F)	+150 °C (+302 °F)
4 to 25	5/32 to 1	> 1 mbar (0.402 inH ₂ O) (0)	> 1 mbar (0.402 inH ₂ O) (0)

Flow limit The diameter of the pipe and the flow rate determine the nominal diameter of the sensor. The optimum flow velocity is between 2 to 3 m/s (6.56 to 9.84 ft/s). Also match the velocity of flow (v) to the physical properties of the fluid:

- $v < 2 \text{ m/s}$ (6.56 ft/s): For abrasive media (e.g. cleaning agents)
- $v > 2 \text{ m/s}$ (6.56 ft/s): For media that produce buildup (e.g. liquids containing oil and sugar)

i A necessary increase in the flow velocity can be achieved by reducing the sensor nominal diameter.

i For an overview of the full scale values for the measuring range, see the "Measuring range" section → 6

- Pressure loss**
- For DN 8 (5/16"), DN 15 (1/2") and DN 25 (1") no pressure loss occurs if the sensor is installed in a pipe with the same nominal diameter.
 - Pressure losses for configurations incorporating adapters according to DIN EN 545 → 22

System pressure

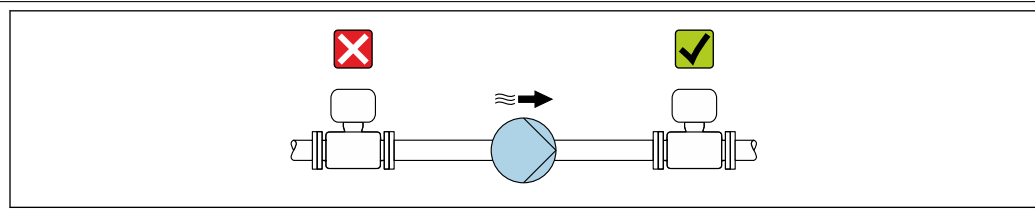

Never install the sensor on the pump suction side in order to avoid the risk of low pressure, and thus damage to the liner.

i Furthermore, install pulse dampers if reciprocating, diaphragm or peristaltic pumps are used.

- For information on the liner's resistance to partial vacuum → 26
- For information on the shock resistance of the measuring system → 25
- For information on the vibration resistance of the measuring system → 25

Vibrations

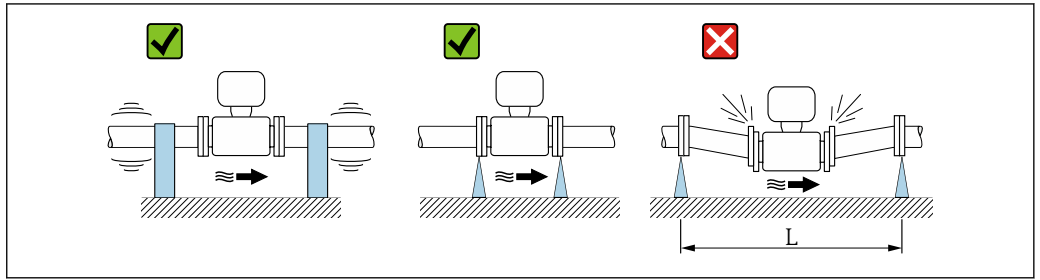

A0029004

11 Measures to avoid device vibrations ($L > 10\text{ m}$ (33 ft))

In the event of very strong vibrations, the pipe and sensor must be supported and fixed.

- For information on the shock resistance of the measuring system → 25
- For information on the vibration resistance of the measuring system → 25

Mechanical construction

Dimensions in SI units

Compact version

Order code for "Housing", option B "Compact IP67 NEMA4X, stainless steel", DN 4 to 15 ($\frac{5}{32}$ to $\frac{1}{2}$ ")

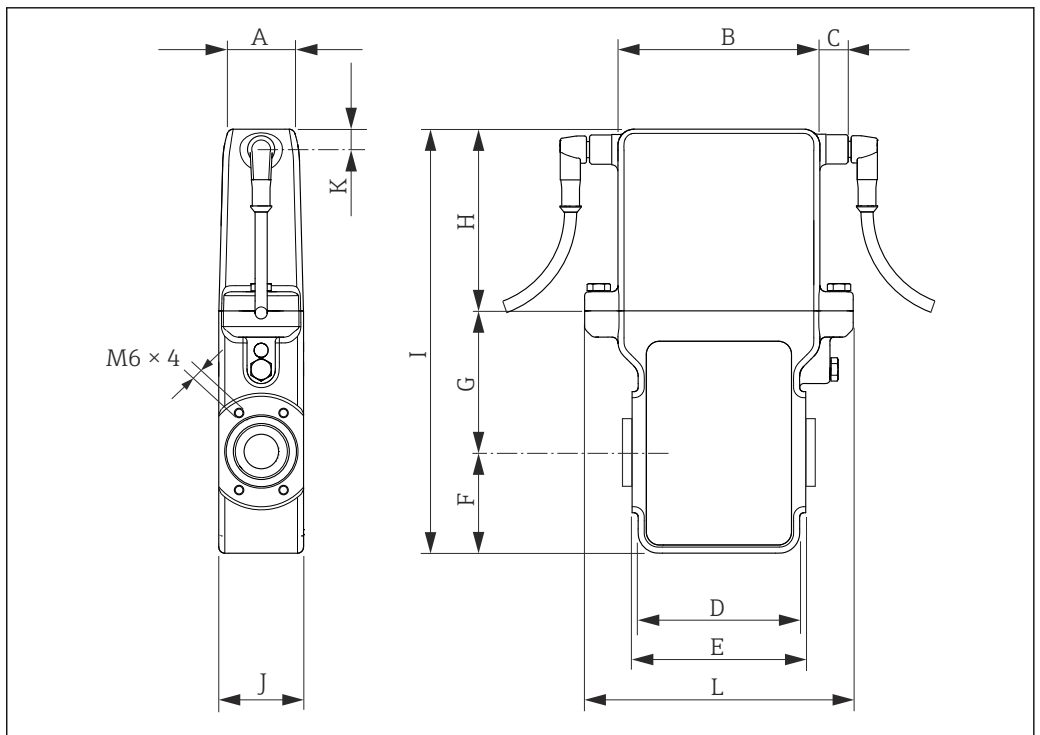

A0003864

L	A	B	C	D	E	F	G	H	I	J	K
[mm]	[mm]	[mm]	[mm]	[mm]	[mm]	[mm]	[mm]	[mm]	[mm]	[mm]	[mm]
133	33.4	100	12	80	86	50	70	90	210	42	10

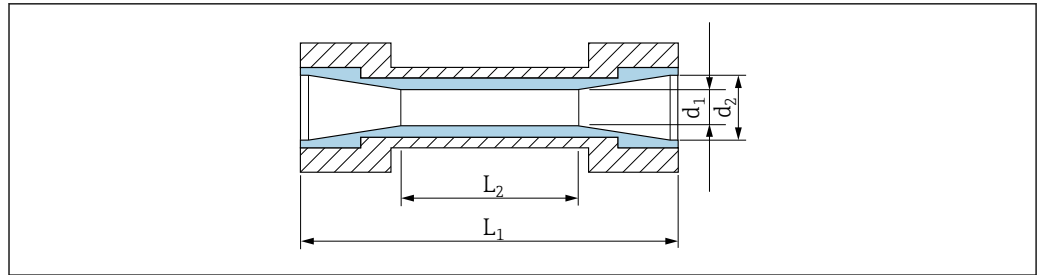

A0004874

12 Measuring tube dimensions

DN [mm]	L_1 ¹⁾ [mm]	L2	d_1 [mm]	d_2
4	94	20	4.5	9
8	94	-	9	9
15K ²⁾	94	20	12	16
15	94	-	16	16

- 1) Total length depends on process connections
- 2) Conical version (corresponds to DN 12)

Order code for "Housing", option B "Compact IP67 NEMA4X, stainless steel", DN 25 (1")

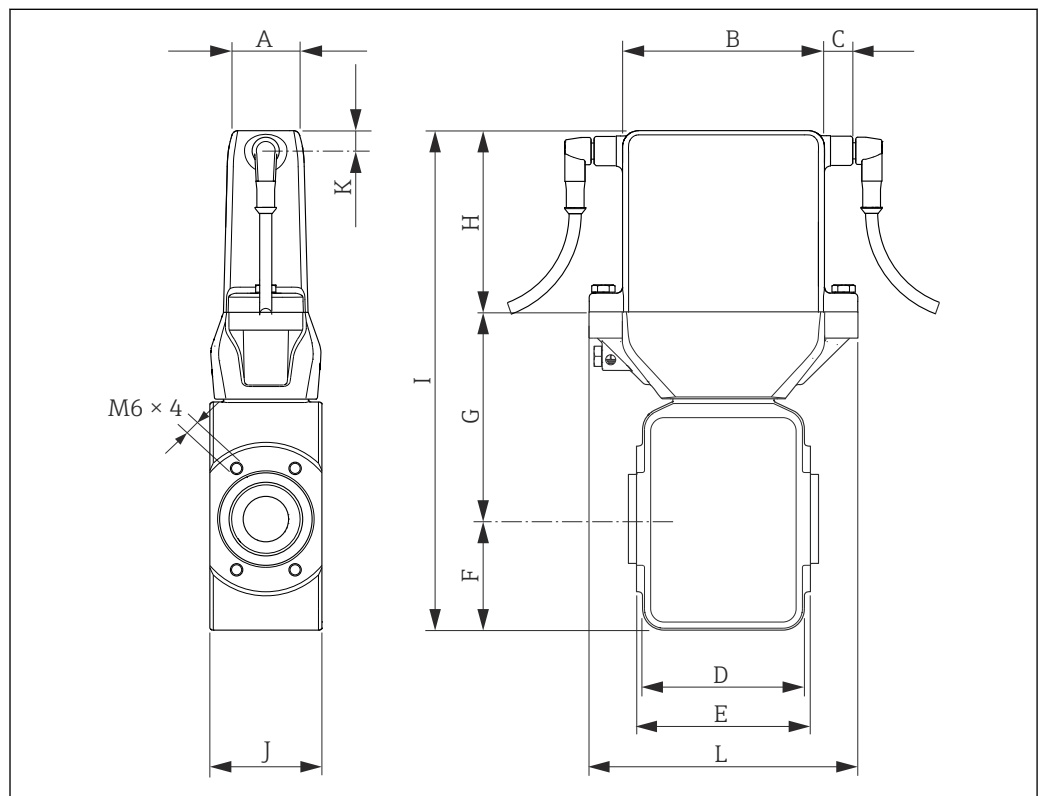

A0025867

L	A	B	C	D	E	F	G	H	I	J	K
[mm]	[mm]	[mm]	[mm]	[mm]	[mm]	[mm]	[mm]	[mm]	[mm]	[mm]	[mm]
133	33.4	100	12	80	86	55	102	90	247	55.5	10

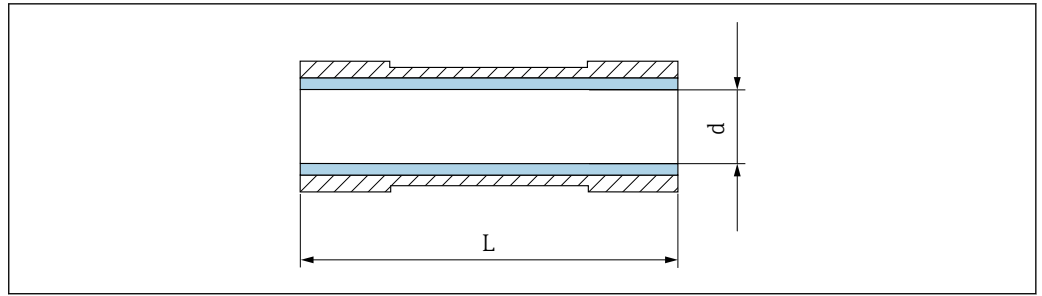

A0025957

13 Measuring tube dimensions

DN [mm]	L ¹⁾ [mm]	d [mm]
25	94	22.6 (ASME)
25	94	26 (DIN)

1) Total length depends on process connections

Welded connections

With O-ring seal

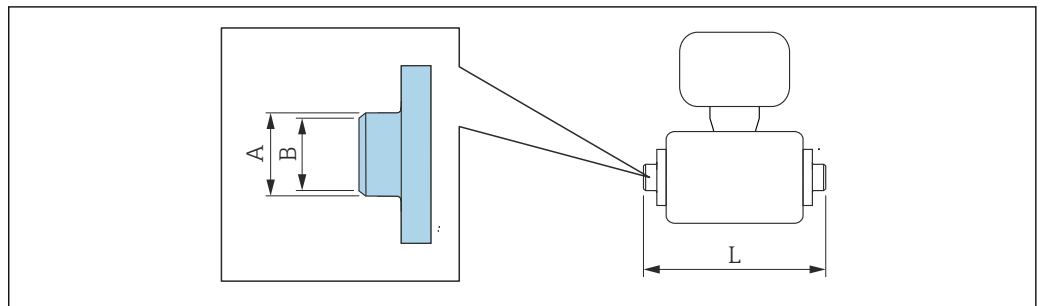

A0027510

i Length tolerance for dimension L in mm:
+1.5 / -2.0

Welded connection as per DIN EN ISO 1127 1.4404 (316L) Order code for "Process connection", option B				
DN [mm]	Suitable for pipe DIN EN ISO 1127 [mm]	A [mm]	B [mm]	L [mm]
8	13.5 × 1.6	13.5	10.3	126.6
15K ¹⁾ 15	21.3 × 1.6	21.3	18.1	126.6

1) Conical version (corresponds to DN 12)

Welded connection as per ODT/SMS 1.4404 (316L) Order code for "Process connection", option C				
DN [mm]	Suitable for pipe ODT/SMS [mm]	A [mm]	B [mm]	L [mm]
8	13.5 × 2.30	13.5	9	126.6
15K ¹⁾ 15	21.3 × 2.65	21.3	16	126.6

1) Conical version (corresponds to DN 12)

With aseptic molded seal:

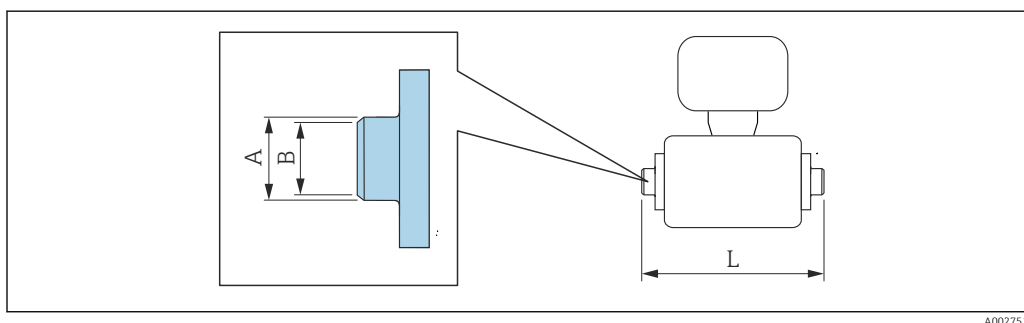

A0027510

i Length tolerance for dimension L in mm:
+1.5 / -2.0

Welded connection EN 10357 (DIN 11850) 1.4404 (316L): Order code for "Process connection", option U				
DN sensor [mm]	Suitable for pipe EN 10357 (DIN 11850) [mm]	A [mm]	B [mm]	L [mm]
4 8	13 × 1.5	13	10	132
15K ¹⁾ 15	19 × 1.5	19	16	132
25	30 × 2	30	26	132.3

It is essential to take the internal diameters of the measuring tube and process connection (B) into account when cleaning with pigs!

1) Conical version (corresponds to DN 12)

Weld-in nipple ODT/SMS 1.4404 (316L): Order code for "Process connection", option V				
DN sensor [mm]	Suitable for pipe ODT/SMS [mm]	A [mm]	B [mm]	L [mm]
4 8	12.7 × 1.65	12	10	118.2
15K ¹⁾ 15	19.05 × 1.65	18	16	118.2

Weld-in nipple ODT/SMS				
<i>1.4404 (316L): Order code for "Process connection", option V</i>				
DN sensor [mm]	Suitable for pipe ODT/SMS [mm]	A [mm]	B [mm]	L [mm]
25	25.4 × 1.60	25	22.6	118.2
It is essential to take the internal diameters of the measuring tube and process connection (B) into account when cleaning with pigs!				

1) Conical version (corresponds to DN 12)

Clamp connections

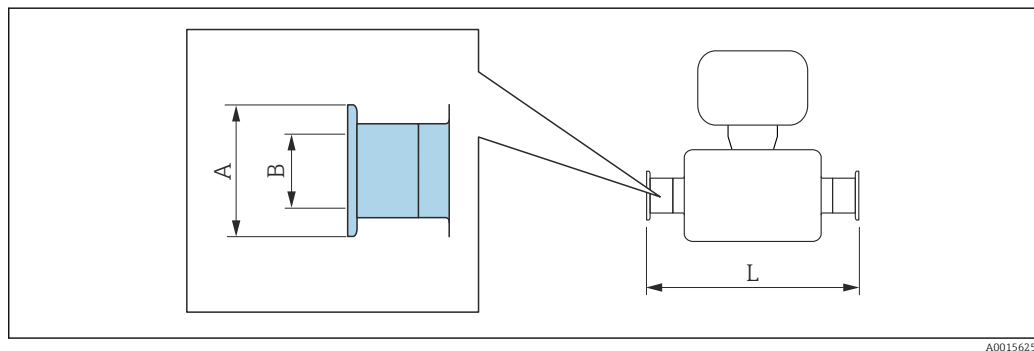

A0015625

 Length tolerance for dimension L in mm:
+1.5 / -2.0

Tri-Clamp L14 AM7				
<i>1.4404 (316L): Order code for "Process connection", option 1</i>				
DN sensor [mm]	Suitable for pipe ODT [mm]	A [mm]	B [mm]	L [mm]
4 8	12.7 × 1.65	25.0	9.4	143
15K ¹⁾ 15	19.1 × 1.65	25.0	15.8	143
25	25.4 × 1.65	50.4	22.1	143
It is essential to take the internal diameters of the measuring tube and process connection (B) into account when cleaning with pigs!				

1) Conical version (corresponds to DN 12)

Tri-Clamp 1" L14 AM7 1.4404 (316L): Order code for "Process connection", option 8				
DN sensor [mm]	Suitable for pipe ODT [mm]	A [mm]	B [mm]	L [mm]
15K ¹⁾ 15	Pipe 25.4 × 1.65	50.4	22.1	143
25	Pipe 25.4 × 1.65	50.4	22.1	143

It is essential to take the internal diameters of the measuring tube and process connection (B) into account when cleaning with pigs!

1) Conical version (corresponds to DN 12)

Tri-Clamp 3/4" (conical) L14 AM7 1.4404 (316L): Order code for "Process connection", option 2				
DN sensor [mm]	Suitable for pipe ODT [mm]	A [mm]	B [mm]	L [mm]
4 8	Pipe 19.1 × 1.65	25.0	9	143

It is essential to take the internal diameters of the measuring tube and process connection (B) into account when cleaning with pigs!

Cable glands

With O-ring seal

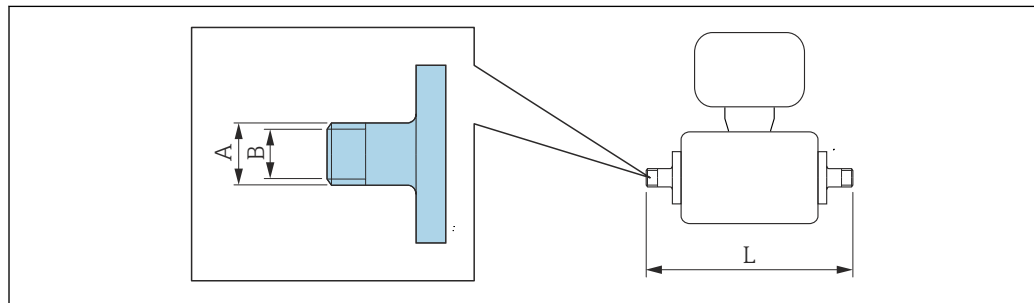

A0027509

i Length tolerance for dimension L in mm:
+1.5 / -2.0

internal thread as per ISO 228/DIN 2999 1.4404 (316L) Order code for "Process connection", option L				
DN [mm]	Suitable for external thread ISO 228 / DIN 2999 [in]	A [mm]	B [mm]	L [mm]
8	Rp 3/8	22	9	176
15K ¹⁾ 15	Rp 1/2	27	16	176

1) Conical version (corresponds to DN 12)

Dimensions in US units

Compact version

Order code for "Housing", option B "Compact IP67 NEMA4X, stainless steel", DN 4 to 15 (5/32 to 1/2")

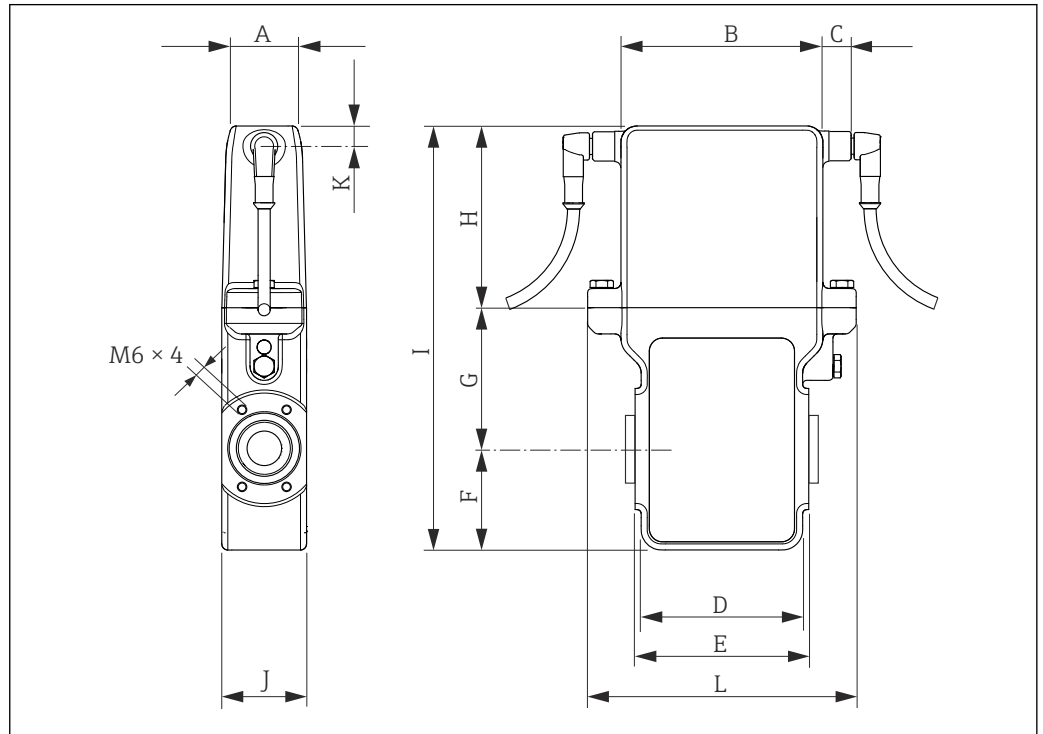

A0003864

L	A	B	C	D	E	F	G	H	I	J	K
[in]	[in]	[in]	[in]	[in]	[in]	[in]	[in]	[in]	[in]	[in]	[in]
5.24	1.31	3.94	0.47	3.15	3.39	1.97	2.76	3.54	8.27	1.65	0.39

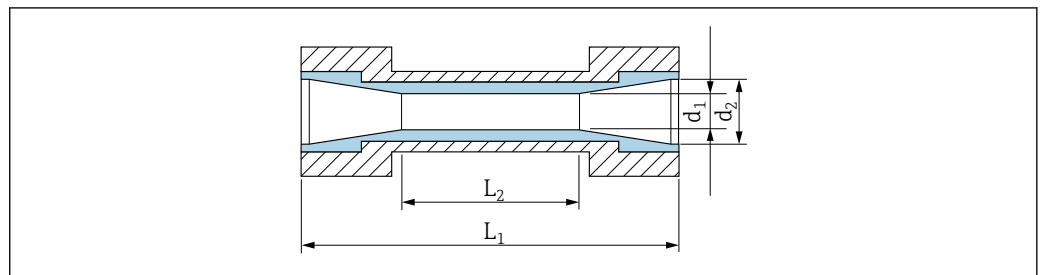

A0004874

14 Measuring tube dimensions

DN	L ¹⁾	L2	d ₁	d ₂
[in]	[in]		[in]	
5/32	3.70	0.79	0.17	0.35
5/16	3.70	-	0.35	0.35
1/2K ²⁾	3.70	0.79	0.47	0.63
1/2	3.70	-	0.63	0.63

- 1) Total length depends on process connections
- 2) Conical version (corresponds to DN 12)

Order code for "Housing", option B "Compact IP67 NEMA4X, stainless steel", DN 25 (1")

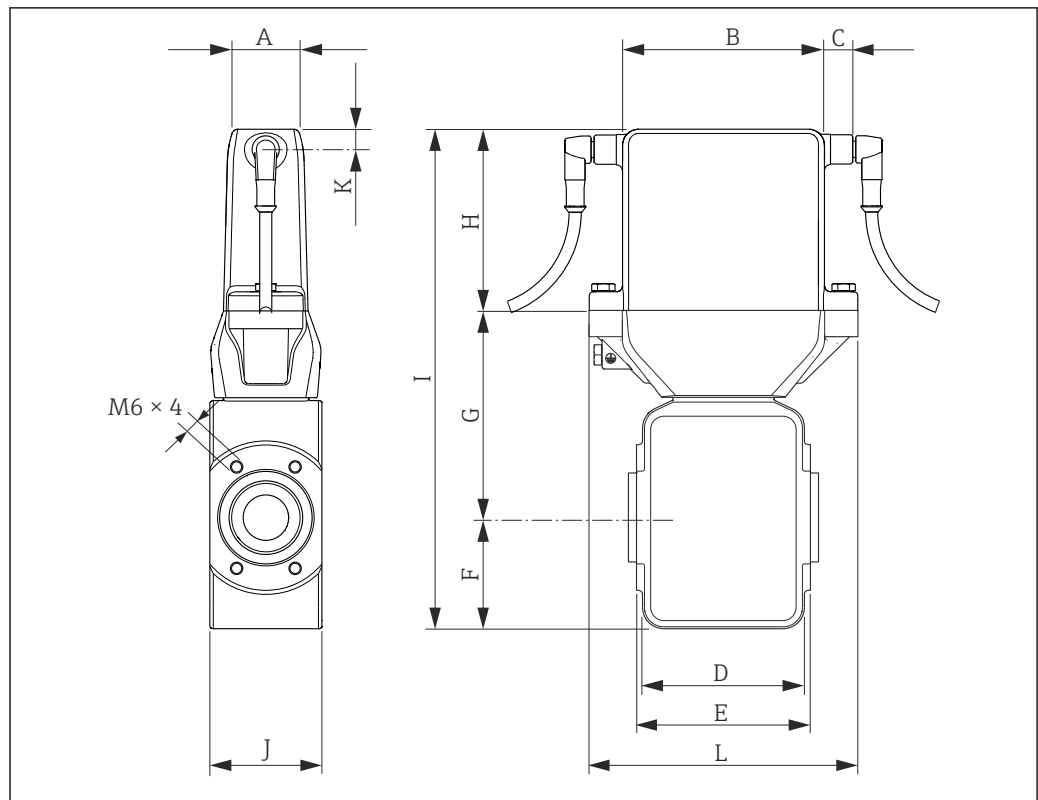

A0025867

L	A	B	C	D	E	F	G	H	I	J	K
[in]	[in]	[in]	[in]	[in]	[in]	[in]	[in]	[in]	[in]	[in]	[in]
5.24	1.31	3.94	0.47	3.15	3.39	2.17	4.02	3.54	9.72	2.19	0.39

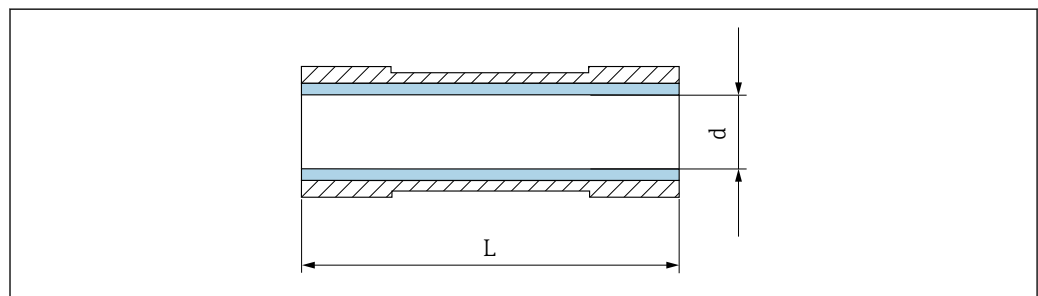

A0025957

15 Measuring tube dimensions

DN	L ¹⁾	d
[in]	[in]	[in]
1	3.70	0.89 (ASME)
1	3.70	1.02 (DIN)

1) Total length depends on process connections

Welded connections

With O-ring seal

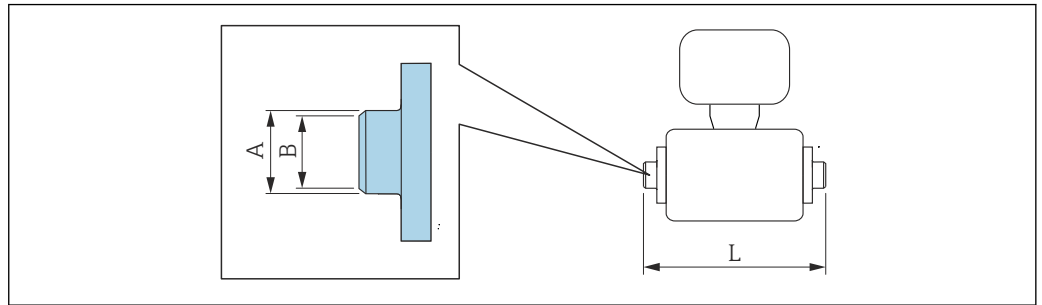

A0027510

i Length tolerance for dimension L in inch:
+0.06 / -0.08

Welded connection as per ODT/SMS 1.4404 (316L) Order code for "Process connection", option C				
DN [in]	Suitable for pipe ODT/SMS [in]	A [in]	B [in]	L [in]
5/16	0.53 × 0.09	0.53	0.35	4.98
1/2K ¹⁾ 1/2	0.84 × 0.10	0.84	0.63	4.98

1) Conical version (corresponds to DN 12)

With aseptic molded seal:

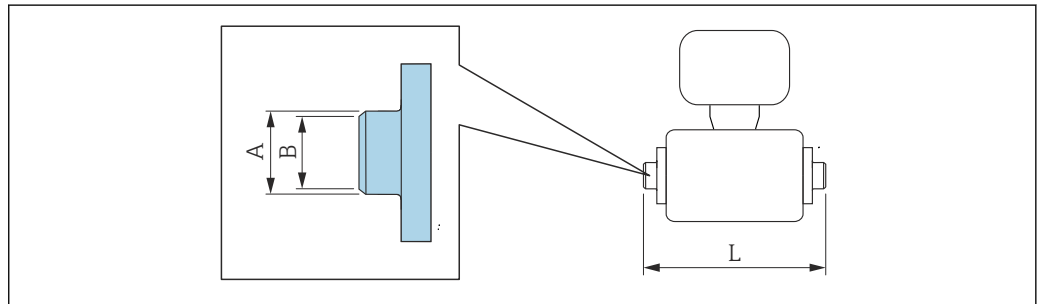

A0027510

i Length tolerance for dimension L in inch:
+0.06 / -0.08

Welded connection EN 10357 (DIN 11850) 1.4404 (316L): Order code for "Process connection", option U				
DN sensor [in]	Suitable for pipe EN 10357 (DIN 11850) [in]	A [in]	B [in]	L [in]
5/32 3/16	0.51 × 0.06	0.51	0.39	5.20
1/2K ¹⁾ 1/2	0.75 × 0.06	0.75	0.63	5.20

Welded connection EN 10357 (DIN 11850)				
<i>1.4404 (316L): Order code for "Process connection", option U</i>				
DN sensor	Suitable for pipe EN 10357 (DIN 11850)	A	B	L
[in]	[in]	[in]	[in]	[in]
1	1.18 × 0.08	1.18	1.02	5.21

It is essential to take the internal diameters of the measuring tube and process connection (B) into account when cleaning with pigs!

1) Conical version (corresponds to DN 12)

Weld-in nipple ODT/SMS				
<i>1.4404 (316L): Order code for "Process connection", option V</i>				
DN sensor	Suitable for pipe ODT/SMS	A	B	L
[in]	[in]	[in]	[in]	[in]
$\frac{5}{32}$ $\frac{5}{16}$	0.50 × 0.06	0.47	0.39	4.65
$\frac{1}{2}K^{1)}$ $\frac{1}{2}$	0.75 × 0.06	0.71	0.63	4.65
1	1 × 0.06	1	0.89	4.65

It is essential to take the internal diameters of the measuring tube and process connection (B) into account when cleaning with pigs!

1) Conical version (corresponds to DN 12)

Clamp connections

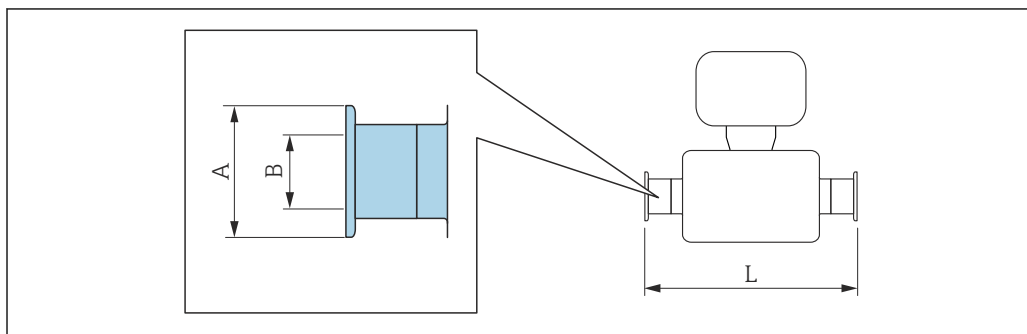

A0015625

i Length tolerance for dimension L in inch:
+0.06 / -0.08

Tri-Clamp L14 AM7				
<i>1.4404 (316L): Order code for "Process connection", option 1</i>				
DN sensor	Suitable for pipe ODT	A	B	L
[in]	[in]	[in]	[in]	[in]
$\frac{5}{32}$ $\frac{5}{16}$	ODT $\frac{1}{2}$	0.98	0.37	5.63
$\frac{1}{2}K^{1)}$ $\frac{1}{2}$	ODT $\frac{3}{4}$	0.62	0.62	5.63

Tri-Clamp L14 AM7 1.4404 (316L): Order code for "Process connection", option 1				
DN sensor [in]	Suitable for pipe ODT [in]	A [in]	B [in]	L [in]
1	ODT 1	1.98	0.87	5.63

It is essential to take the internal diameters of the measuring tube and process connection (B) into account when cleaning with pigs!

1) Conical version (corresponds to DN 12)

Tri-Clamp 1" L14 AM7 1.4404 (316L): Order code for "Process connection", option 8				
DN sensor [in]	Suitable for pipe ODT [in]	A [in]	B [in]	L [in]
½K ¹⁾ ½	1	1.98	0.87	5.63
1	1	1.98	0.87	5.63

It is essential to take the internal diameters of the measuring tube and process connection (B) into account when cleaning with pigs!

1) Conical version (corresponds to DN 12)

Tri-Clamp 3/4" (conical) L14 AM7 1.4404 (316L): Order code for "Process connection", option 2				
DN sensor [in]	Suitable for pipe ODT [in]	A [in]	B [in]	L [in]
5/32 5/16	ODT ¾	1.12	0.35	5.63

It is essential to take the internal diameters of the measuring tube and process connection (B) into account when cleaning with pigs!

Cable glands

With O-ring seal

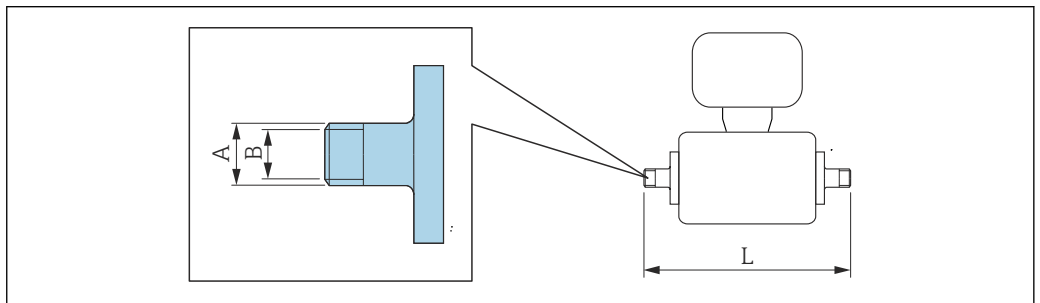

 Length tolerance for dimension L in inch:
+0.06 / -0.08

internal thread as per ISO 228/DIN 2999 1.4404 (316L) Order code for "Process connection", option L				
DN	Suitable for external thread ISO 228 / DIN 2999	A	B	L
[in]	[in]	[in]	[in]	[in]
$\frac{5}{16}$	Rp 3/8	0.87	0.35	6.93
$\frac{1}{2}$ ¹⁾ $\frac{1}{2}$	Rp 1/2	1.06	0.63	6.93

1) Conical version (corresponds to DN 12)

Weight

Compact version

Weight in SI units

DN [mm]	Weight [kg]
4	2.8
8	2.8
15	2.8
25	4.3

Weight in US units

DN [in]	Weight [lbs]
$\frac{5}{32}$	6.17
$\frac{5}{16}$	6.17
$\frac{1}{2}$	6.17
1	9.48

Materials

Transmitter housing

- Acid and alkali-resistant outer surface
- Stainless steel 1.4308 (304)

Device plugs

Electrical connection	Material
Plug M12x1	<ul style="list-style-type: none"> ■ Socket: Stainless steel, 1.4404 (316L) ■ Contact housing: Polyamide ■ Contacts: Gold-plated brass

Sensor housing

- Acid and alkali-resistant outer surface
- Stainless steel 1.4301 (304)

Measuring tube

Stainless steel 1.4301 (304)

Liner



PFA

Electrodes

- 1.4435 (316L)
- Alloy C22, 2.4602 (UNS N06022)
- Platinum
- Tantalum

Process connections

- Weld-in nipple: 1.4404 (316L)
- Weld-in nipple, aseptic: 1.4404 (316L)
- Tri-Clamp: 1.4404 (316L)
- Couplings: 1.4404 (316L)

 List of all available process connections →  39

Seals

Molded seal (EPDM, silicone, Viton)

Fitted electrodes

- Standard: stainless steel 1.4435 (316L)
- Optional: Alloy C22, 2.4602 (UNS N06022), platinum, tantalum

Process connections

With O-ring seal

Welded connections

- DIN EN ISO 1127
- ODT/SMS

Coupling

ISO 228/DIN 2999

With aseptic molded seal:

Welded connections

- EN 10357, DIN 11850
- ODT/SMS

Tri-Clamp

L14 AM7

 For information on the different materials used in the process connections →  39

Surface roughness

Stainless steel electrodes, 1.4435 (304L); Alloy C22, 2.4602 (UNS N06022), platinum, tantalum:
0.3 to 0.5 µm (11.8 to 19.7 µin)

Liner with PFA:
≤ 0.4 µm (15.7 µin)

Process connection:
≤ 0.8 µm (31 µin)
(All data relate to parts in contact with fluid)

Operability

Local operation

This device cannot be operated locally using a display or operating elements.

Remote operation

Using service adapter and Commubox FXA291

Operation and configuration can be performed using the Endress+Hauser FieldCare or DeviceCare service and configuration software.

The device is connected to the USB port of the computer via the service adapter and Commubox FXA291.

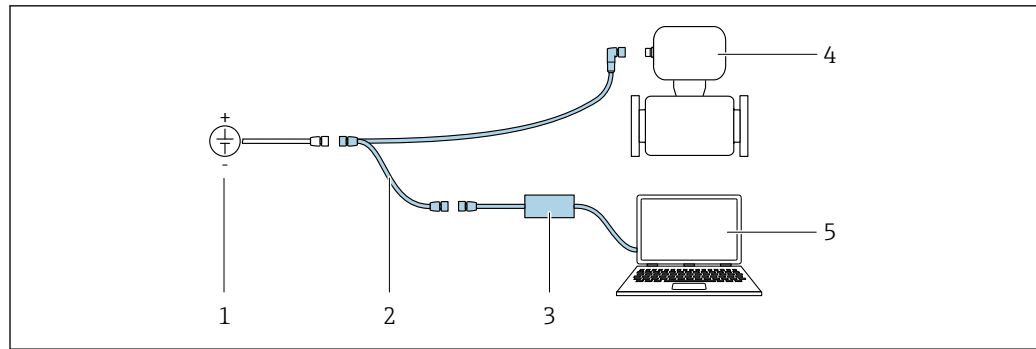

A0032567

- 1 Supply voltage 24 V DC
- 2 Service adapter
- 3 Commubox FXA291
- 4 Measuring device
- 5 Computer with "FieldCare" or "DeviceCare" operating tool

i The service adapter, cable and Commubox FXA291 are not included in the delivery. These components can be ordered as accessories → 41.

Certificates and approvals

CE mark

The measuring system is in conformity with the statutory requirements of the applicable EC Directives. These are listed in the corresponding EC Declaration of Conformity along with the standards applied.

Endress+Hauser confirms successful testing of the device by affixing to it the CE mark.

C-Tick symbol

The measuring system meets the EMC requirements of the "Australian Communications and Media Authority (ACMA)".

Ex approval

The measuring device is certified for use in hazardous areas and the relevant safety instructions are provided in the separate "Safety Instructions" (XA) document. Reference is made to this document on the nameplate.

i The separate Ex documentation (XA) containing all the relevant explosion protection data is available from your Endress+Hauser sales center.

ATEX, IECEX

Currently, the following versions for use in hazardous areas are available:

Ex nA

Category	Type of protection
IIG	Ex nA IIC T5 to T1 Gc

cCSAus

Currently, the following versions for use in hazardous areas are available:

Class I Division 2 Groups ABCD

Sanitary compatibility

- 3A approval and EHEDG-certified
- Seals → FDA-compliant

Pressure Equipment Directive

- With the PED/G1/x (x = category) marking on the sensor nameplate, Endress+Hauser confirms compliance with the "Essential Safety Requirements" specified in Annex I of the Pressure Equipment Directive 97/23/EC.
- Devices bearing this marking (PED) are suitable for the following types of medium:
Media in Group 1 and 2 with a vapor pressure greater than, or smaller and equal to 0.5 bar (7.3 psi)
- Devices not bearing this marking (PED) are designed and manufactured according to good engineering practice. They meet the requirements of Art.3 Section 3 of the Pressure Equipment Directive 97/23/EC. The range of application is indicated in tables 6 to 9 in Annex II of the Pressure Equipment Directive.

Measuring instrument approval

Dosimag is suitable as an (optional) component for recording volume in legally regulated measuring systems for AdBlue / DEF (Diesel Exhaust Fluid) in accordance with Appendix MI-005 of the European Measuring Instruments Directive 2014/32/EU. Dosimag is certified in accordance with OIML R117-1:2007 / OIML R117-2:2014 and has an MID evaluation certificate confirming conformity with the basic requirements of the Measuring Instruments Directive.

Other standards and guidelines

- EN 60529
Degrees of protection provided by enclosures (IP code)
- EN 61010-1
Safety Requirements for Electrical Equipment for Measurement, Control and Laboratory Use
- IEC/EN 61326
Emission in accordance with Class A requirements. Electromagnetic compatibility (EMC requirements).
- CAN/CSA C22.2 No. 61010-1-12
Safety Requirements for Electrical Equipment for Measurement, Control and Laboratory Use, Part 1: General Requirements
- ANSI/ISA-61010-1 (82.02.01)
Safety Requirements for Electrical Equipment for Measurement, Control and Laboratory Use – Part 1: General Requirements

Ordering information

Detailed ordering information is available from the following sources:

- In the Product Configurator on the Endress+Hauser website: www.endress.com -> Click "Corporate" -> Select your country -> Click "Products" -> Select the product using the filters and search field -> Open product page -> The "Configure" button to the right of the product image opens the Product Configurator.
- From your Endress+Hauser Sales Center: www.addresses.endress.com



Product Configurator - the tool for individual product configuration

- Up-to-the-minute configuration data
- Depending on the device: Direct input of measuring point-specific information such as measuring range or operating language
- Automatic verification of exclusion criteria
- Automatic creation of the order code and its breakdown in PDF or Excel output format
- Ability to order directly in the Endress+Hauser Online Shop

Accessories



Various accessories, which can be ordered with the device or subsequently from Endress+Hauser, are available for the device. Detailed information on the order code in question is available from your local Endress+Hauser sales center or on the product page of the Endress+Hauser website: www.endress.com.

Device-specific accessories

For the sensor



Accessories	Description	Order code
Seal set	For regular replacement of the seals on the process connections.	DK5G**-***
Housing seal	To seal the transmitter	50102857
Mounting set	Consists of: <ul style="list-style-type: none"> ▪ 2 process connections ▪ Screws ▪ Seals 	DKH**-****

Communication-specific accessories

Accessories	Description
FieldCare	FDT-based plant asset management tool from Endress+Hauser. It can configure all smart field units in your system and helps you manage them. By using the status information, it is also a simple but effective way of checking their status and condition.  For details, see Operating Instructions BA00027S and BA00059S
DeviceCare	Tool for connecting and configuring Endress+Hauser field devices.  For details, see Innovation brochure IN01047S
Commubox FXA291	Connects Endress+Hauser field devices with a CDI interface (= Endress+Hauser Common Data Interface) and the USB port of a computer or laptop.  For details, see the "Technical Information" document TI405C/07
Adapter connection	Adapter connections for installation on other electrical connections: <ul style="list-style-type: none"> ▪ Adapter FXA291 (order number: 71035809) ▪ Adapter RSE8 (order number: 50107169) RSE8 connection jack, 8-pin adapter (RSE8), 24 V DC, pulse, status ▪ Adapter RSE5 (order number: 50107168) RSE8 connection jack, 5-pin adapter (RSE5), 24 V DC, pulse, status ▪ Adapter RSE4 (order number: 50107167) RSE8 connection jack, 4-pin adapter (RSE4), 24 V DC, pulse
Connecting cable RSE8	Cable RKWTN8-56/5 P92, length: 5 m (Order number: 50107895)

Service-specific accessories

Accessories	Description
Applicator	Software for selecting and sizing Endress+Hauser measuring devices: <ul style="list-style-type: none"> ▪ Calculation of all data required to determine the optimum flowmeter: e.g. nominal diameter, pressure loss, accuracy or process connections. ▪ Graphic illustration of the calculation results Administration, documentation and access to all project-related data and parameters throughout the entire life cycle of a project. Applicator is available: <ul style="list-style-type: none"> ▪ Via the Internet: https://wapps.endress.com/applicator ▪ On CD-ROM for local PC installation.
W@M	Life cycle management for your plant W@M supports you with a wide range of software applications over the entire process: from planning and procurement, to the installation, commissioning and operation of the measuring devices. All the relevant information is available for every measuring device over time entire life cycle, such as the Device status, spare parts, device-specific documentation. The application already contains the data of your Endress+Hauser device. Endress+Hauser also takes care of maintaining and updating the data records. W@M is available: <ul style="list-style-type: none"> ▪ Via the Internet: www.endress.com/lifecyclemanagement ▪ On CD-ROM for local PC installation.

FieldCare	FDT-based plant asset management tool from Endress+Hauser. It can configure all smart field units in your system and helps you manage them. By using the status information, it is also a simple but effective way of checking their status and condition.  For details, see Operating Instructions BA00027S and BA00059S
DeviceCare	Tool for connecting and configuring Endress+Hauser field devices.  For details, see Innovation brochure IN01047S
Commubox FXA291	Connects Endress+Hauser field devices with a CDI interface (= Endress+Hauser Common Data Interface) and the USB port of a computer or laptop.  For details, see "Technical Information" TI00405C

Supplementary documentation

-  For an overview of the scope of the associated Technical Documentation, refer to the following:
- The *W@M Device Viewer* : Enter the serial number from the nameplate (www.endress.com/deviceviewer)
 - The *Endress+Hauser Operations App*: Enter the serial number from the nameplate or scan the 2-D matrix code (QR code) on the nameplate.

Standard documentation

Brief Operating Instructions

Measuring device	Documentation code
Dosimag	KA01175D

Operating Instructions

Measuring device	Documentation code	
	Pulse/frequency/status output Option 3	Modbus RS485 Options 4, 5 and 6
Dosimag	BA00098D	BA01321D

Description of device parameters

Measuring device	Documentation code	
	Pulse/frequency/status output Option 3	Modbus RS485 Options 4, 5 and 6
Dosimag	GP01049D	GP01048D

Supplementary device-dependent documentation

Safety Instructions

Contents	Documentation code
ATEX/IECEX Ex nA	XA01332D
cCSAus	FES0231
UL Class 1 Division 2	XA01377D

Special Documentation

Contents	Documentation code
Information on Custody Transfer Measurement	SD01514D

Registered trademarks

Modbus®

Registered trademark of SCHNEIDER AUTOMATION, INC.

TRI-CLAMP®

Registered trademark of Ladish & Co., Inc., Kenosha, USA

Applicator®, FieldCare®, DeviceCare®

Registered or registration-pending trademarks of the Endress+Hauser Group

www.addresses.endress.com
