

# Operating Instructions

## Flowphant T DTT31, DTT35

Flow switch





# Table of contents

<b>1</b>	<b>About this document</b> .....	<b>4</b>	<b>10</b>	<b>Accessories</b> .....	<b>34</b>
1.1	Document function .....	4	10.1	Device-specific accessories .....	34
1.2	Symbols used .....	4	10.2	Communication-specific accessories ...	36
<b>2</b>	<b>Basic safety instructions</b> .....	<b>6</b>	<b>11</b>	<b>Technical data</b> .....	<b>38</b>
2.1	Requirements for the personnel .....	6	11.1	Input .....	38
2.2	Designated use .....	6	11.2	Output .....	38
2.3	Workplace safety .....	6	11.3	Power supply .....	38
2.4	Operational safety .....	6	11.4	Environment .....	39
2.5	Product safety .....	7	11.5	Process .....	40
2.6	IT security .....	7	11.6	Mechanical construction .....	41
<b>3</b>	<b>Incoming acceptance and product identification</b> .....	<b>7</b>	11.7	Certificates and approvals .....	44
3.1	Incoming acceptance .....	7	11.8	Supplementary documentation .....	46
3.2	Product identification .....	8			
3.3	Name and address of manufacturer .....	9			
3.4	Certificates and approvals .....	9			
3.5	Storage and transport .....	9			
<b>4</b>	<b>Mounting</b> .....	<b>9</b>			
4.1	Mounting requirements .....	9			
<b>5</b>	<b>Electrical connection</b> .....	<b>15</b>			
5.1	Connecting requirements .....	15			
<b>6</b>	<b>Operating options</b> .....	<b>17</b>			
6.1	Overview of operating options .....	17			
6.2	Structure and function of the operating menu .....	19			
6.3	Access to the operating menu via the operating tool .....	29			
<b>7</b>	<b>Diagnostics and troubleshooting</b> .....	<b>30</b>			
7.1	General troubleshooting .....	30			
7.2	Firmware history .....	32			
<b>8</b>	<b>Maintenance</b> .....	<b>33</b>			
8.1	Cleaning .....	33			
<b>9</b>	<b>Repair</b> .....	<b>33</b>			
9.1	Return .....	33			
9.2	Disposal .....	33			

# 1 About this document

## 1.1 Document function

These Operating Instructions contain all the information that is required in various phases of the life cycle of the device: from product identification, incoming acceptance and storage, to mounting, connection, operation and commissioning through to troubleshooting, maintenance and disposal.

## 1.2 Symbols used

### 1.2.1 Safety symbols

#### DANGER

This symbol alerts you to a dangerous situation. Failure to avoid this situation will result in serious or fatal injury.

#### WARNING

This symbol alerts you to a dangerous situation. Failure to avoid this situation can result in serious or fatal injury.





#### CAUTION

This symbol alerts you to a dangerous situation. Failure to avoid this situation can result in minor or medium injury.













#### NOTICE

This symbol contains information on procedures and other facts which do not result in personal injury.







### 1.2.2 Electrical symbols

Symbol	Meaning
	Direct current
	Alternating current
	Direct current and alternating current
	<b>Ground connection</b> A grounded terminal which, as far as the operator is concerned, is grounded via a grounding system.
	<b>Protective Earth (PE)</b> A terminal which must be connected to ground prior to establishing any other connections.  The ground terminals are situated inside and outside the device: <ul style="list-style-type: none"> <li>■ Inner ground terminal: Connects the protective earth to the mains supply.</li> <li>■ Outer ground terminal: Connects the device to the plant grounding system.</li> </ul>

### 1.2.3 Symbols for certain types of information

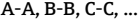
Symbol	Meaning
	<b>Permitted</b> Procedures, processes or actions that are permitted.
	<b>Preferred</b> Procedures, processes or actions that are preferred.
	<b>Forbidden</b> Procedures, processes or actions that are forbidden.
	<b>Tip</b> Indicates additional information.
	Reference to documentation
	Reference to page
	Reference to graphic
	Notice or individual step to be observed
	Series of steps
	Result of a step
	Help in the event of a problem
	Visual inspection

### 1.2.4 Symbols in graphics

Symbol	Meaning
	Item numbers
	Series of steps
	Views
	Sections
	Hazardous area
	Safe area (non-hazardous area)
	Flow direction

## 2 Basic safety instructions

### 2.1 Requirements for the personnel

The personnel for installation, commissioning, diagnostics and maintenance must fulfill the following requirements:

- ▶ Trained, qualified specialists must have a relevant qualification for this specific function and task.
- ▶ Are authorized by the plant owner/operator.
- ▶ Are familiar with federal/national regulations.
- ▶ Before starting work, read and understand the instructions in the manual and supplementary documentation as well as the certificates (depending on the application).
- ▶ Follow instructions and comply with basic conditions.

The operating personnel must fulfill the following requirements:

- ▶ Are instructed and authorized according to the requirements of the task by the facility's owner-operator.
- ▶ Follow the instructions in this manual.

### 2.2 Designated use

The device is a flow switch for monitoring mass flow rates in industrial processes. The device is designed to meet state-of-the-art safety requirements and complies with applicable standards and EC regulations. The device can, however, be a source of danger if used incorrectly or for anything other than the designated use.

The manufacturer is not liable for damage caused by improper or non-designated use.

### 2.3 Workplace safety

For work on and with the device:

- ▶ Wear the required personal protective equipment according to federal/national regulations.

For welding work on the piping:

- ▶ Do not ground the welding unit via the measuring device.

If working on and with the device with wet hands:

- ▶ Due to the increased risk of electric shock, gloves must be worn.

### 2.4 Operational safety

#### ■ Functional safety:

The device has been developed according to the IEC 61508 and IEC 61511-1 (FDIS) standards. The device version with a PNP switch output and additional analog output is fitted with mechanisms for error detection and prevention within the electronics and software.

#### ■ Hazardous area:

The device is not approved for use in hazardous areas.

Risk of injury!

- ▶ Operate the device in proper technical condition and fail-safe condition only.
- ▶ The operator is responsible for the interference-free operation of the device.

### **Modifications to the device**

Unauthorized modifications to the device are not permitted and can lead to unforeseeable dangers:

- ▶ If modifications are nevertheless required, consult with the manufacturer.

### **Repair**

To ensure continued operational safety and reliability:

- ▶ Carry out repairs on the device only if they are expressly permitted.
- ▶ Observe federal/national regulations pertaining to the repair of an electrical device.
- ▶ Use only original spare parts and accessories from the manufacturer.

## **2.5 Product safety**

This measuring device is designed in accordance with good engineering practice to meet state-of-the-art safety requirements, has been tested, and left the factory in a condition in which it is safe to operate.

It meets general safety standards and legal requirements. It also complies with the EU directives listed in the device-specific EU Declaration of Conformity.

## **2.6 IT security**

Our warranty is valid only if the device is installed and used as described in the Operating Instructions. The device is equipped with security mechanisms to protect it against any inadvertent changes to the settings.

IT security measures, which provide additional protection for the device and associated data transfer, must be implemented by the operators themselves in line with their security standards.

# **3 Incoming acceptance and product identification**

## **3.1 Incoming acceptance**

Proceed as follows on receipt of the device:

1. Check whether the packaging is intact.
2. If damage is discovered:  
Report all damage immediately to the manufacturer.
3. Do not install damaged material, as the manufacturer cannot otherwise guarantee compliance with the safety requirements and cannot be held responsible for the consequences that may result.

- 4. Compare the scope of delivery to the contents of the order.
- 5. Remove all the packaging material used for transportation.

### 3.2 Product identification

The device can be identified in the following ways:

- Nameplate specifications
- Enter the serial number from the nameplate in the *W@M Device Viewer* [www.endress.com/deviceviewer](http://www.endress.com/deviceviewer): All data relating to the device and an overview of the Technical Documentation supplied with the device are displayed.

#### 3.2.1 Nameplate

The nameplate illustrated below is designed to help users identify specific product information, such as the serial number, design, variables, configuration and device approvals:

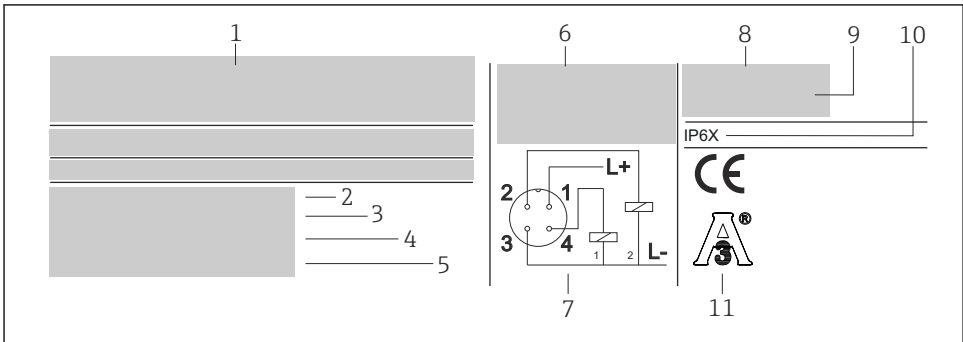

A0008138

1 Nameplate for device identification

- 1 Manufacturer's details
- 2 Order code
- 3 Serial number
- 4 Tag number
- 5 Release number
- 6 Connection data
- 7 Connection diagram
- 8 Measuring range
- 9 Ambient temperature
- 10 Degree of protection
- 11 Approvals

 Compare and check the data on the nameplate of the device against the requirements of the measuring point.



### 3.3 Name and address of manufacturer



<b>Name of manufacturer:</b>	Endress+Hauser Wetzler GmbH + Co. KG
<b>Address of manufacturer:</b>	Obere Wank 1, D-87484 Nesselwang or <a href="http://www.endress.com">www.endress.com</a>

### 3.4 Certificates and approvals

#### 3.4.1 CE mark

The product meets the requirements of the harmonized European standards. As such, it complies with the legal specifications of the EC directives. The manufacturer confirms successful testing of the product by affixing to it the CE-mark.

#### 3.4.2 Hygiene standard

- EHEDG certification, type EL CLASS I. EHEDG-certified/tested process connections  
→  42
- 3-A Authorization No. 1144, 3-A Sanitary Standard 74-07. Listed process connections  
→  43

### 3.5 Storage and transport



Pack the device in such a way that it is reliably protected against impact during storage (and transportation). The original packaging provides optimum protection.

<b>Storage temperature</b>	-40 to +85 °C (-40 to +185 °F)
----------------------------	--------------------------------

## 4 Mounting

### 4.1 Mounting requirements

#### 4.1.1 Dimensions

→  41

#### 4.1.2 Ambient temperature range

<b>T<sub>a</sub></b>	-40 to +85 °C (-40 to +185 °F)
----------------------	--------------------------------

### 4.1.3 General installation instructions



#### NOTICE

##### Damage to the device.

- ▶ To ensure correct monitoring, the sensor must be installed in a way that produces a fully developed flow profile.
- ▶ Stabilization sections (5x DN) must be provided in the pipe downstream from a pump, pipe elbows, internal fixtures and cross-sectional changes.

#### NOTICE

##### Damage to the device.

- ▶ Do not turn the device into the process connection thread at the housing →  10.
- ▶ Always install the device at the wrench flats.
- ▶ Use a suitable open-ended wrench →  10.
- ▶ The local display can be rotated electronically by 180° →  17.
- ▶ The top housing section can be rotated mechanically by up to 310°.

- The sensor tip must be completely surrounded by the medium
- Position the sensor tip in the area of maximum flow velocity (pipe center)
- Minimum sensor immersion length  
 $L_i \geq 10 \text{ mm}$  (0.4 in).

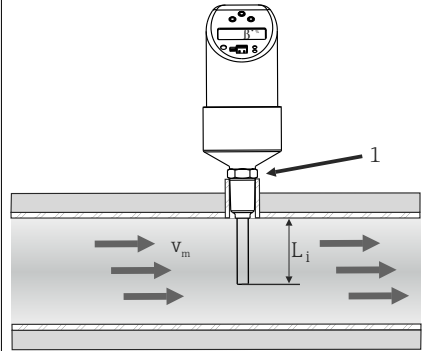

A0006976

2 Installation instructions (example)

Orientation

- For horizontal pipes: lateral installation. Installation from above only if the pipe is completely filled with medium
- For vertical pipes: installation in the ascending pipe
- For DTT35: Install at an angle of at least  $3^\circ$  to guarantee self-draining.

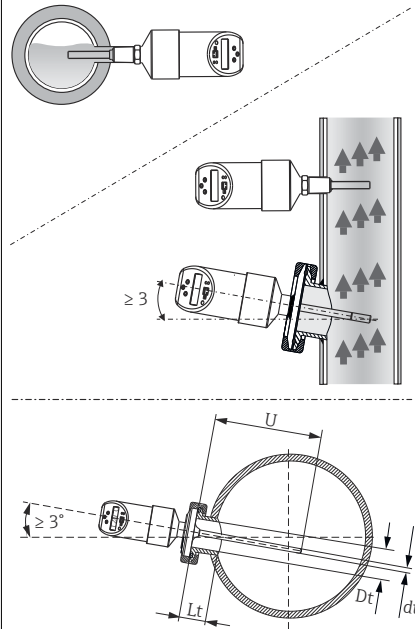

A0044425

3 Correct orientation

**NOTICE**

**If the device is installed incorrectly this can result in incorrect measurements!**

- ▶ Do not install in down pipes open towards the end.
- ▶ The sensor tip should never touch the pipe wall.

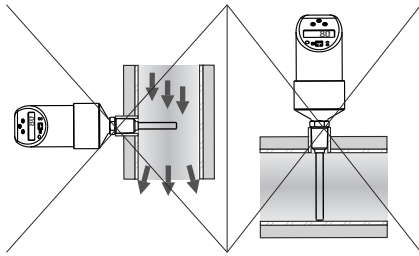

A0006978

 4 *Incorrect installation!*

#### 4.1.4 Installation instructions when installing in hygienic processes

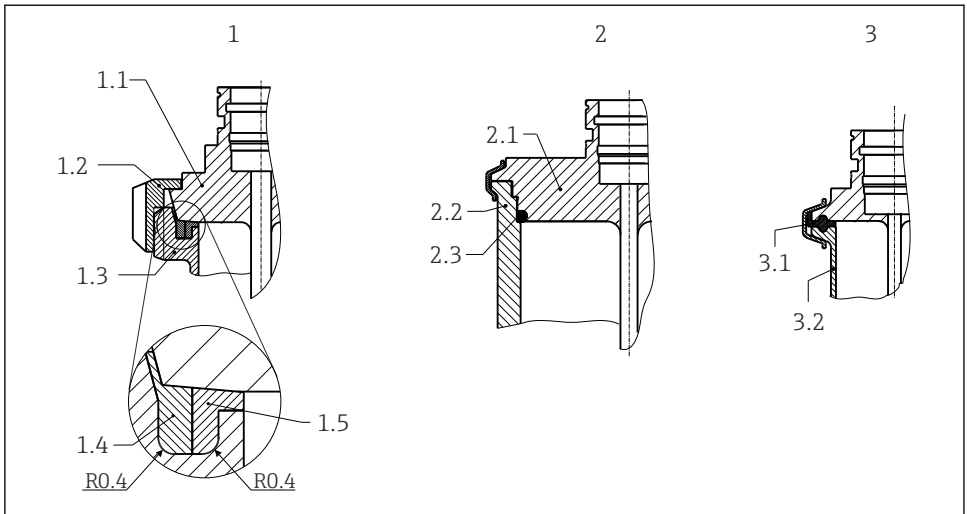

A0044659

##### 5 Detailed installation instructions for hygiene-compliant installation

- 1 Milk pipe connection according to DIN 11851 (PL, PG, PH connection), only in conjunction with EHEDG-certified and self-centering sealing ring
  - 1.1 Sensor with milk pipe connection
  - 1.2 Groove slip-on nut
  - 1.3 Counterpart connection
  - 1.4 Centering ring
  - 1.5 Sealing ring
- 2 Varivent® and APV-Inline (LB, LL, HL connection)
  - 2.1 Sensor with Varivent® connection
  - 2.2 Counterpart connection
  - 2.3 O-ring
- 3 Clamp according to ISO 2852 (DB, DL connection), EHEDG certified only in conjunction with seal according to EHEDG position paper
  - 3.1 Molded seal
  - 3.2 Counterpart connection

-  The requirements of the EHEDG and the 3-A Sanitary Standard must be adhered to.
- Installation instruction EHEDG/cleanability:  $Lt \leq (Dt-dt)$
- Installation instruction 3-A/cleanability:  $Lt \leq 2(Dt-dt)$

In the case of weld-in connections, exercise the necessary degree of care when performing the welding work on the process side:

1. Use suitable welding material.
2. Flush-weld or weld with welding radius  $\geq 3.2$  mm (0.13 in).

3. Avoid crevices, folds or gaps.
4. Ensure the surface is honed and polished,  $R_a \leq 0.76 \mu\text{m}$  (30  $\mu\text{in}$ ).

Pay attention to the following when installing the thermometer to ensure that the cleanability is not affected:

1. The installed sensor is suitable for CIP (cleaning in place). Cleaning is carried out in combination with tubing/piping or tank/vessel. In the case of internal tank fixtures using process connection nozzles, it is important to ensure that the cleaning assembly sprays this area directly so that it is cleaned properly.
2. The Varivent® connections enable flush-mounted installation.

#### NOTICE

**The following action must be taken if a sealing ring (O-ring) or seal fails:**

- ▶ The thermometer must be removed.
- ▶ The thread and the O-ring joint/sealing surface must be cleaned.
- ▶ The sealing ring or seal must be replaced.
- ▶ CIP must be performed after installation.

#### 4.1.5 Inlet and outlet runs

#### NOTICE

**The thermal measuring principle is sensitive to disturbed flow conditions.**

- ▶ Install the measuring device as far away as possible from any flow disturbances. For further information → ISO 14511.
- ▶ Install the sensor upstream from fittings such as valves, T-pieces, elbows etc.
- ▶ To attain the specified level of accuracy of the measuring device, the inlet and outlet runs mentioned below must be maintained at the very minimum.
- ▶ If several flow disturbances are present, maintain the longest specified inlet run.

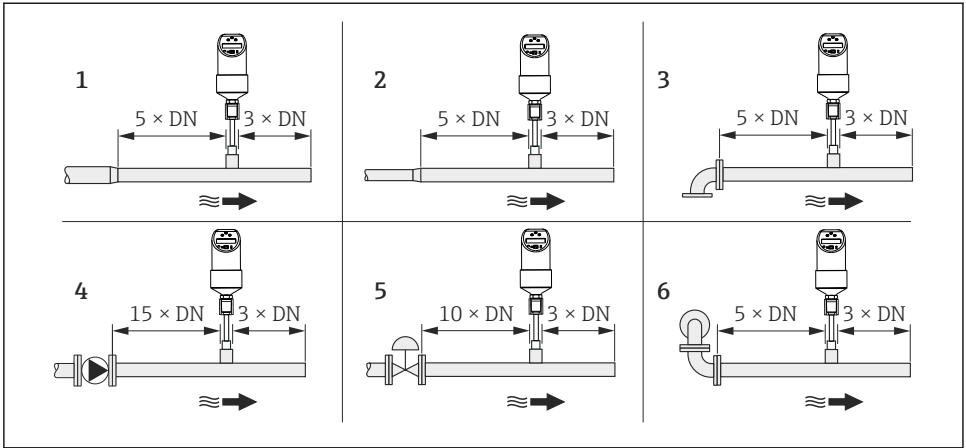

A0023225

## 6 Inlet and outlet runs

- 1 Reduction
- 2 Extension
- 3 90° elbow or T-piece
- 4 Pump
- 5 Control valve
- 6 2x 90° elbow, 2- or 3-dimensional

## 5 Electrical connection

### 5.1 Connecting requirements

#### 5.1.1 DC voltage version with M12x1 connector

DTT35: According to the 3-A Sanitary Standard and EHEDG electrical connecting cables must be smooth, corrosion-resistant and easy to clean.

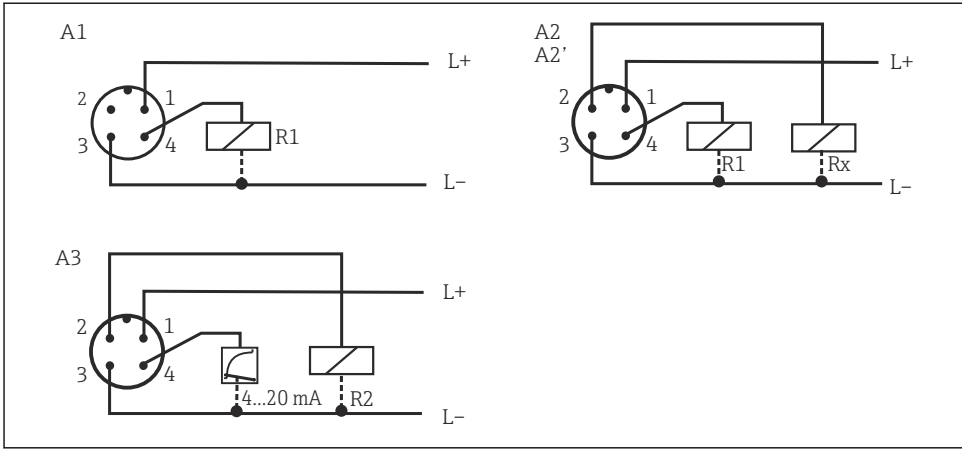

A0006818

7 Flow switch with M12x1 connector

Item no.	Output setting
A1	1x PNP switch output
A2	2x PNP switch output R1 and Rx (R2)
A2'	2x PNP switch output R1 and Rx (diagnostics/NC contact with "DESINA" setting)
A3	1x PNP switch output and 1x analog output (4 to 20 mA)

### **WARNING**

**Observe the following to avoid damaging the analog input of a PLC:**

- ▶ Do not connect the active PNP switch output of the device to the 4 to 20 mA input of a PLC.

DESINA: distributed and standardized installation technology for machine tools and manufacturing systems, → 25.

R2 = diagnostics/NC contact (for more information on DESINA, see [www.desina.de](http://www.desina.de))

### **NOTICE**

**The sensor tip of the device heats up once the device is connected to the power supply! The temperature can increase to approx. 90 °C (194 °F).**

- ▶ As the device sensor tip heats up, appropriate protective clothing must be worn!



### 5.1.2 DC voltage version with valve connector

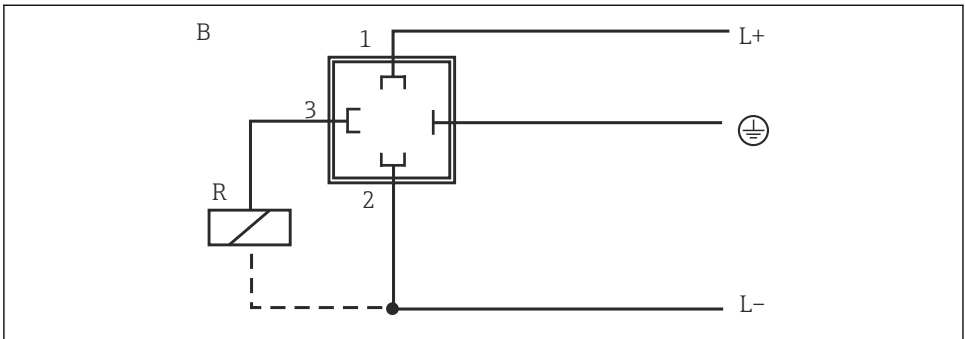

A0035798

8 Flow switch with M16x1.5 valve connector or NPT 1/2"

Item no.	Output setting
B	1x PNP switch output

## 6 Operating options

### 6.1 Overview of operating options

The device is operated via three keys. The digital display and the light emitting diodes (LED) assist navigation through the operating menu.

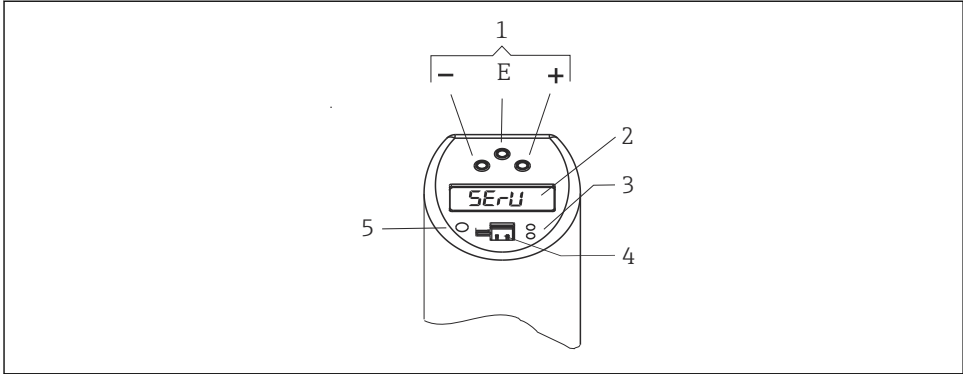

A0044663

**9** Position of the operating elements and possibilities for display

- 1 Operating keys
- 2 Digital display: illuminated white (= ok); red (= alarm/error)
- 3 Yellow LED for switching states: LED on = switch closed; LED off = switch open
- 4 Communication jack for PC configuration
- 5 LED for status display: green = OK; red = error/fault; flashing red/green = warning

**i** To prevent damage to the keys, do not operate them with a pointed object!

## 6.2 Structure and function of the operating menu

### 6.2.1 Navigation in the operating menu

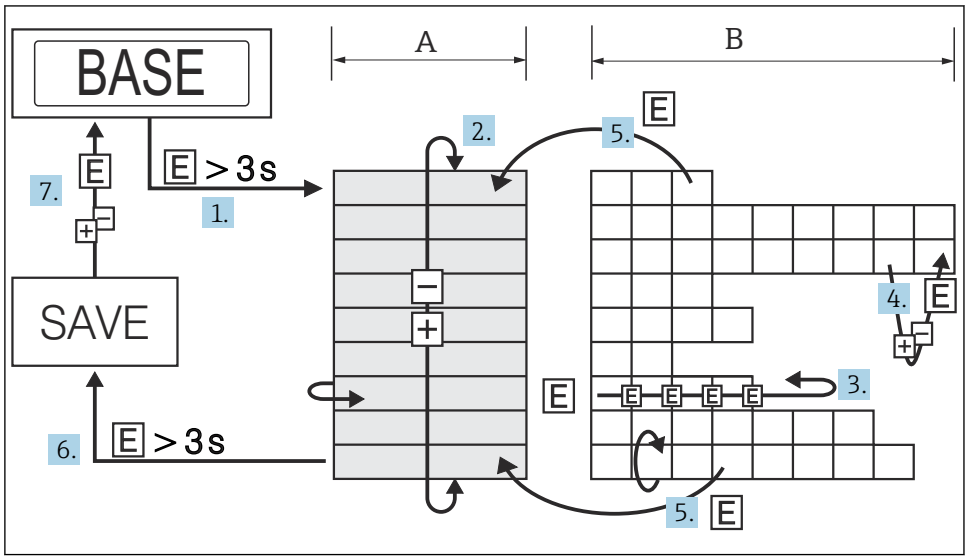

A0035802

10 Navigation in the operating menu

A Function group selection

B Function selection

1. To enter the operating menu, press the E key for longer than 3 s.
2. Select the "Function group" with the + or – key.
3. Select the "Function" with the E key.
4. If software locking is enabled, it must be disabled before making entries or changes. Enter and change the parameters with the + or – key.
5. Press the E key to return to "Function".
6. Press the E repeatedly to return to "Function group" until the relevant function group is reached.
7. To return to the measuring position (Home), press the E key for longer than 3 s.
8. To display the prompt to save data (press + or – to select the option "YES" or "NO"), confirm with the E key.



If "YES" is selected when asked to save the data, changes are made to the parameter settings.

## 6.2.2 Navigating the Calibration (CAL) function group

Variable limits for HIF (Learn High Flow) or LOWF (Learn Low Flow) can be set with the 'Learn Function'.

- HIF setting (Learn High Flow): Enter any flow rate from 70 to 100 % of the maximum value in the process. The device then uses this value to automatically calculate the corresponding 100 % value.
- LOWF setting (Learn Low Flow): Enter any flow rate from 0 to 20 % of the maximum value in the process. The device then uses this value to automatically calculate the corresponding 0 % value.

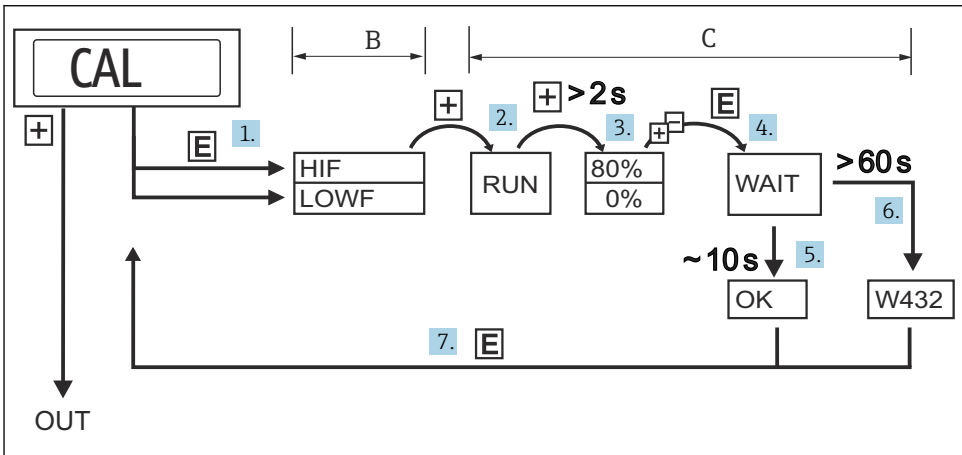

A0010787

### 11 Navigating the 'Learn' function taking the example of the Calibration (CAL) function group

- B Function selection  
C Selection of settings

1. Select the "HIF" (Learn High Flow) or "LOWF" (Learn Low Flow) function with the E key.
2. Select the "RUN" function with the + key; the Learn function is initialized.
3. Select the flow rate with the + key; press for longer than 2 s.
4. If "HIF" (Learn High Flow) is set, the upper flow rate (70 to 100 %) is selected. Enter the current relative flow rate in increments of 1 % with the + or - key (factory setting 80 %).
5. If "LOWF" (Learn Low Flow) is set, the lower flow rate (0 to 20 %) is selected. Enter the current relative flow rate in increments of 1 % with the + or - key (factory setting 0%).
6. Select the "WAIT" function with the E key.
7. Accept ('learn') the current measured value after approx. 10 s - "OK" appears on the display.

8. Or: The message "W432" appears on the display after 60 s. A sufficiently stable flow could not be detected during the learning process. The system takes an average of the 10 values last measured during the learning process.
9. Return to the CAL function group (Home position) with the E key.

**i** The device is still operative if message W432 is displayed. There can be large measuring uncertainties, however. Recommendation: Repeat the learning process (points 1 to 4) until "OK" appears on the display.

### 6.2.3 Navigating the function switch point "Learn" (SPL)

Variable limits for HIF (Learn High Flow) or LOWF (Learn Low Flow) can be set with the 'Learn Function'.

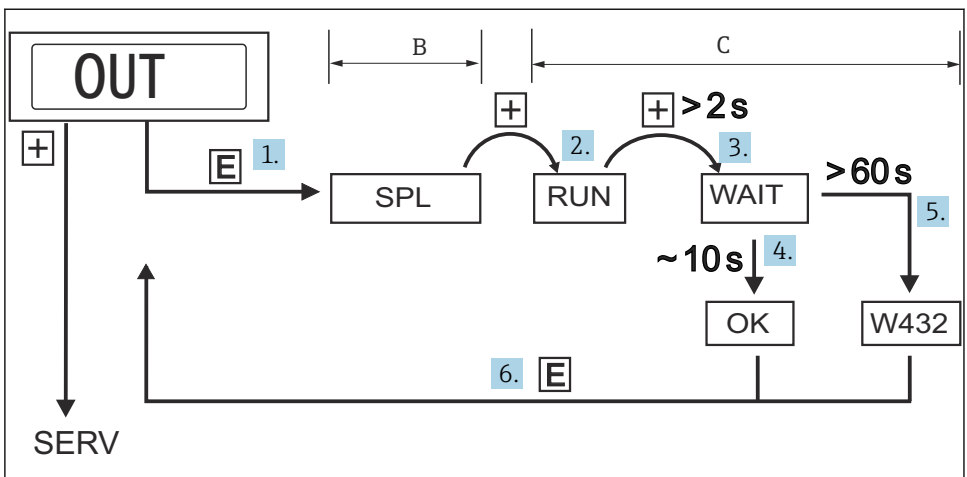

A0005785

#### **12** Navigating the function switch point 'Learn' (SPL)

- B Function selection  
C Selection of settings

1. Select SPL (switch point 'Learn'), optionally SPL2 (switch point 2 'Learn') with the E key.
2. Select the "RUN" function with the + key; the Learn function is initialized.
3. Select the "WAIT" function with the + key; press for longer than 2 s.
4. Accept ('learn') the current measured value after approx. 10 s- "OK" appears on the display.
5. Or: The message "W432" or "NOK" appears on the display after 60 s. W432: A sufficiently stable flow could not be detected during the learning process. The system takes an average of the 10 values last measured during the learning process.

6. NOK: The switch point determined is under 5 % of the measuring range and cannot be accepted because the switch point must be at least 5 % greater than the switchback point (RSP).

 The device is still operative if message "W432" or "NOK" is displayed. There can be large deviations at the switch point, however. Recommendation: Repeat the learning process (points 1 to 4) until "OK" appears on the display.

### 6.2.4 Structure of the operating menu for 2 switch outputs

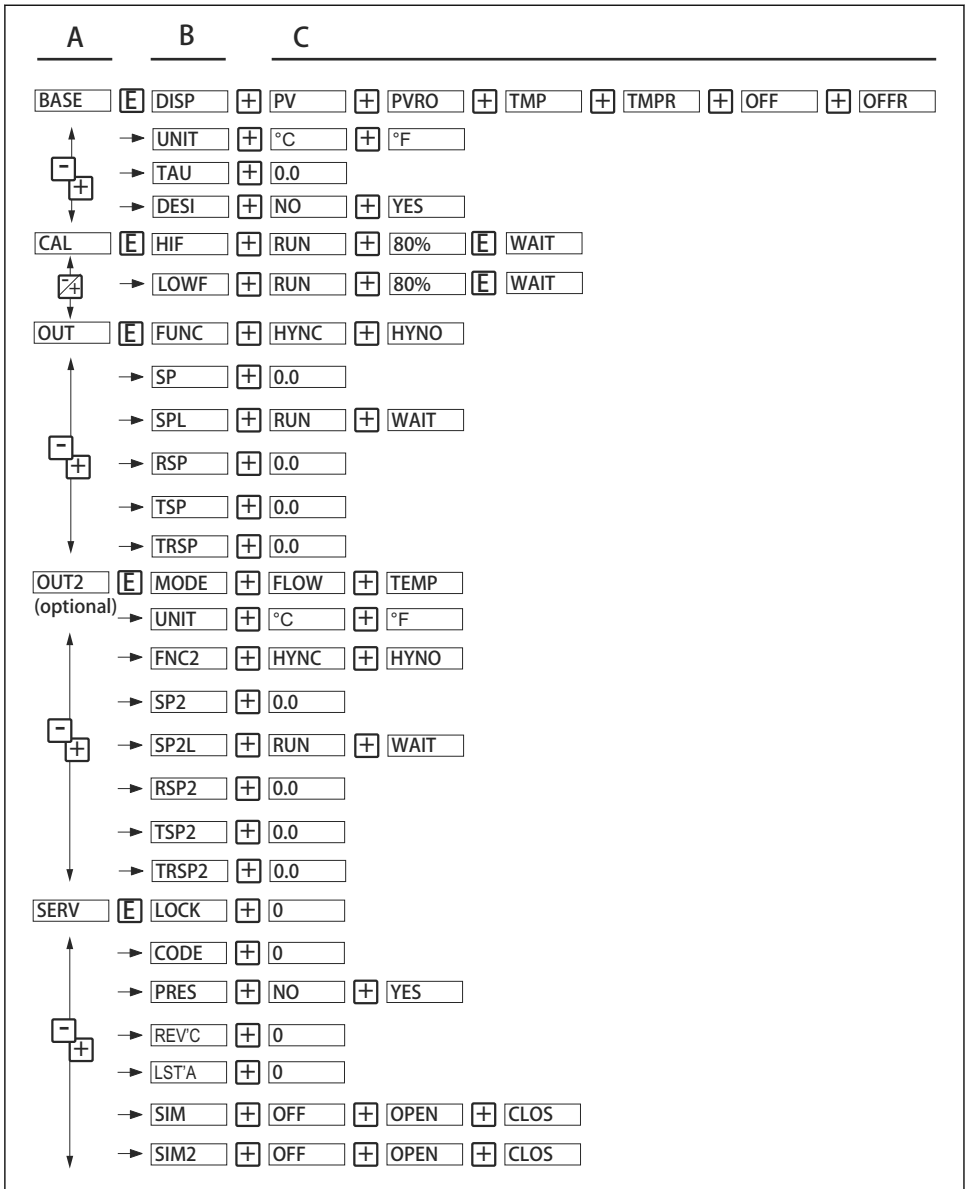

A0005784

13 Operating menu

- A Function groups
- B Functions
- C Settings

### 6.2.5 Structure of the operating menu for 1 x analog output (4 to 20 mA) and 1 x switch output

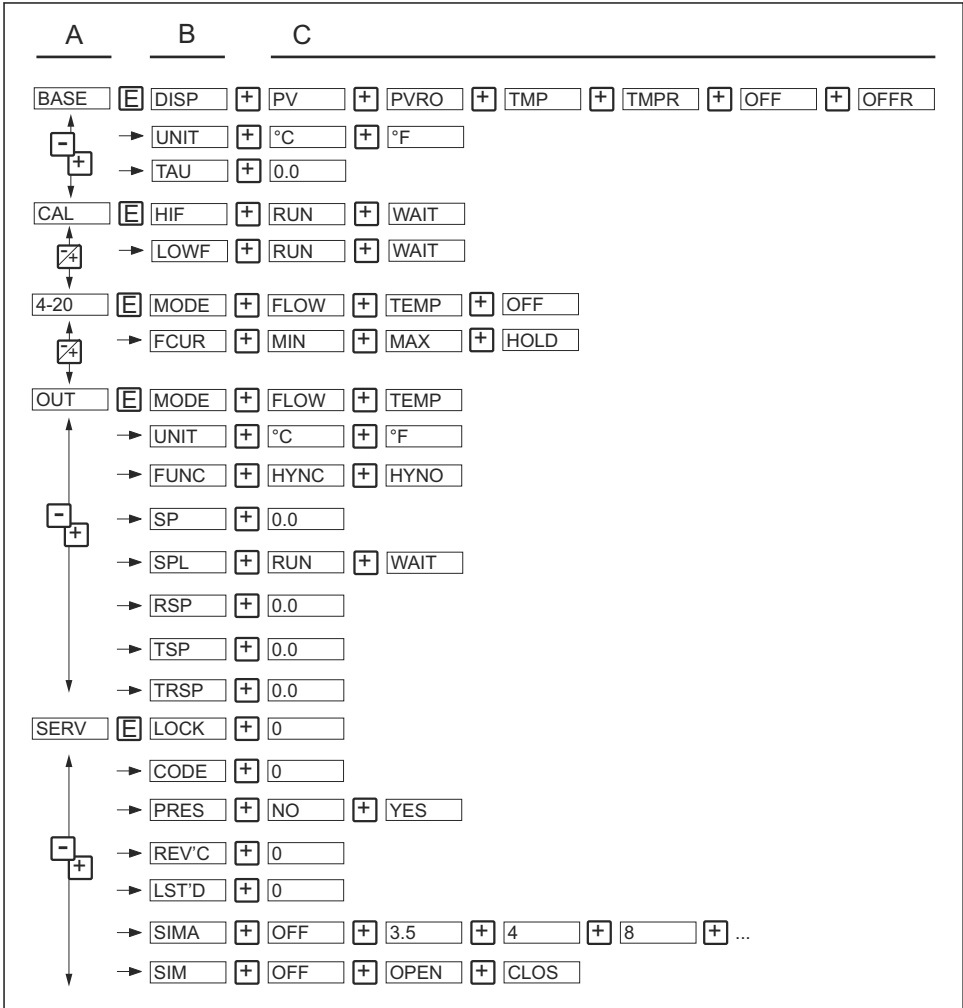

A0006819

14 Operating menu





- A Function groups
- B Functions
- C Settings



## 6.2.6 Basic settings

Function group	Function		Settings	Description
BASE Basic settings	DISP	Display	PV	Displays the current measured value
			PVRO	Displays the current measured value rotated by 180 °
			TMP	Display of current medium temperature
			TMPR	Displays the current medium temperature rotated by 180 °
			OFF	Display off
			OFFR	Display off, rotated by 180 °
				Factory setting: <b>current measured value (PV)</b>
	UNIT	Technical unit	xC xF	Medium temperature displayed in the unit °C or °F   Only visible if the current medium temperature TMP is selected in the DISP mode.  Factory setting: °C
	TAU	Damping	0,0	Measured value damping with regard to display value and output: 0 (no damping) or 9 to 40 s (in increments of 1 s)  Factory setting: <b>0 s</b>
	DESI	DESINA Only for 2 x PNP switch outputs	NO YES	Behavior as per DESINA: The PIN assignment of the M12 connector is in accordance with the DESINA Guidelines (DESINA = distributed and standardized installation technology for machine tools and manufacturing systems)  Factory setting: <b>NO</b>

## 6.2.7 Calibration

Function group	Function		Settings	Description
CAL Calibration	HIF	Learn High Flow	RUN WAIT	Setting for the maximum flow rate that occurs. 100 % value →  11,  20
	LOWF	Learn Low Flow	RUN WAIT	Setting for the maximum flow rate that occurs. 0 % value →  11,  20

### 6.2.8 Settings for output - 2 x switch output

Functions of the switch point

- Hysteresis function: The hysteresis function enables two-point control via a hysteresis. Depending on the mass flow, the hysteresis can be set via the switch point SP and switchback point RSP.
- NO contact or NC contact: This switch function can be selected as required.
- Delay times for switch point SP and switchback point RSP can be configured in increments of 1 s. This makes it possible to filter out undesired temperature peaks of short duration or of high frequency.

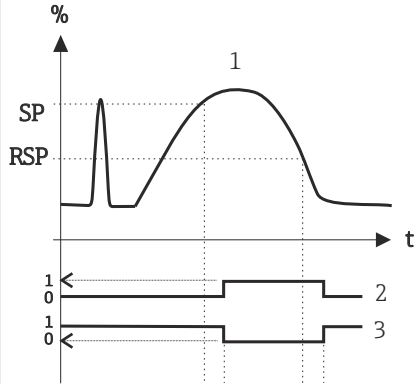

A0005280

- 15 SP switch point; RSP switchback point
- 1 Hysteresis function
  - 2 NO contact
  - 3 NC contact

Function group	Function		Settings	Description
<b>OUT</b> Output 1 <b>OUT2</b> Output 2, optional	<b>MODE</b>	Switching mode	<b>FLOW TEMP</b>	Output switching mode for channel 2 FLOW: flow rate TEMP: temperature  Factory setting: <b>FLOW</b>
				<b>UNIT</b>
	<b>FUNC FNC2</b>	Switching characteristics	<b>HUNC</b>	
				<b>HYNO</b>
	<b>SP SP2</b>	Switch point value	<b>0,0</b>	

Function group	Function		Settings	Description
	SPL SP2L	Switch point "Learn"	<b>RUN WAIT</b>	RUN, WAIT: Take the current flow rate as the switch point SP or SP2. →  12,  21
	RSP RSP2	Switchback point value	<b>0,0</b>	Enter value 0 to 95 % in increments of 1 %. Factory setting: <b>40 %</b>  Value must be at least 5 % less than switch point (SP or SP2).  <b>or optionally for RSP2:</b> Enter value -20 to +80 °C (-4 to +176 °F) in increments of 1 °C (1 °F) if the switching mode MODE is set to temperature TEMP.  Value must be at least 5 °C (9 °F) less than switch point 2 (SP2).  Factory setting: <b>50 °C</b>
	TSP TSP2			Switch point delay
	TRSP TRSP2	Switchback point delay	<b>0,0</b>	Can be configured from 0 to 99 s in increments of 1 s, as required.  Factory setting: <b>0 s</b>

### 6.2.9 Settings for output - 1 x analog output (4 to 20 mA) and 1 x switch output

Function group	Function		Settings	Description
4-20 Output 1	MODE	Measured variable for analog output	<b>FLOW TEMP</b>	Output FLOW: flow rate or TEMP: temperature  If TEMP (temperature) is set, the measuring range is fixed at -20 to +85 °C (-4 to +185 °F) .  Factory setting: <b>FLOW</b>
	FCUR	Failure current	<b>MIN MAX HOLD</b>	Current value in the event of an error: MIN = ≤ 3.5 mA MAX = ≥ 21.7 mA HOLD = last current value  Factory setting: <b>MAX</b>
OUT Output 2	MODE	Switching mode	<b>FLOW TEMP</b>	Output switching mode FLOW: flow rate or TEMP: temperature  Factory setting: <b>temperature (TEMP)</b>
	UNIT	Technical unit	<b>xC xF</b>	Temperature unit selection (°C or °F)  Function is only visible if the switching mode MODE is set to temperature TEMP in the 2nd output.

Function group	Function		Settings	Description
				Factory setting: °C
	FUNC	Switching characteristics	HYNC HYNO	HYNC: hysteresis/NC contact HYNO: hysteresis/NO contact →  26
				Factory setting: <b>HYNO</b>
	SP	Value switch point	0,0	Enter value 5 to 100% in increments of 1 %.
				Factory setting: <b>50%</b>
				Enter value -15 to +85 °C (-5 to +185 °F) in increments of 1 °C (1 °F) if the switching mode MODE is set to temperature TEMP.
				Factory setting: <b>55 °C</b>
	SPL	Switch point 'Learn'	RUN WAIT	RUN, WAIT: Take the current flow rate as the switch point SP. See 'Navigating the Learn function'→  11,  20.
	RSP	Switchback point value	0,0	Enter value 0 to 95% in increments of 1 %.
				Value must be at least 5 % less than switch point SP.
				Factory setting: <b>40 %</b>
				Enter value -20 to +80 °C (-4 to +176 °F) in increments of 1 °C (1 °F) if the switching mode MODE is set to temperature TEMP.
				Value must be at least 5 °C (9 °F) less than switch point SP2.
				Factory setting: <b>50 °C</b>
	TSP	Switch point delay	0,0	Can be configured from 0 to 99 s in increments of 1 s, as required
				Factory setting: <b>0 s</b>
	TRSP	Switchback point delay	0,0	Can be configured from 0 to 99 s in increments of 1 s, as required
				Factory setting: <b>0 s</b>

### 6.2.10 Setting the service functions

Function group	Function		Settings	Description
SERV Service functions	LOCK	Locking code	0	Enter the device locking code.
	Code	Change locking code	0	User-defined numerical code 1 to 9999 0= no locking Only visible if the locking code is valid.
	PRES	Reset	NO YES	Reset all entries to the delivery settings.

Function group	Function		Settings	Description
	<b>REVC</b>	Static revision counter	<b>0</b>	Configuration counter, incremented each time the configuration is changed.
	<b>STAT</b>	Device status		
	<b>LST'D</b>	Last error	<b>0</b>	Displays the last error to occur.
Switch output version	<b>SIM</b> <b>SIM2</b>	Simulation for 2 x switch output	<b>OFF</b> <b>OPEN</b> <b>CLOS</b>	No simulation Switch output open Switch output closed
Analog output version (4 to 20 mA)	<b>SIM</b> <b>SIM2</b>	Simulation for 1 x analog output (SIMA) and 1 x switch output (SIM)	<b>OFF</b> <b>OPEN</b> <b>CLOS</b>	No simulation Switch output open Switch output closed
			<b>3.5</b> <b>4</b> <b>8</b> ...	3.5, 4, 8...: Simulation values for analog output in mA (3.5/4.0/8.0/12.0/16.0/20.0/21.7)

### 6.3 Access to the operating menu via the operating tool

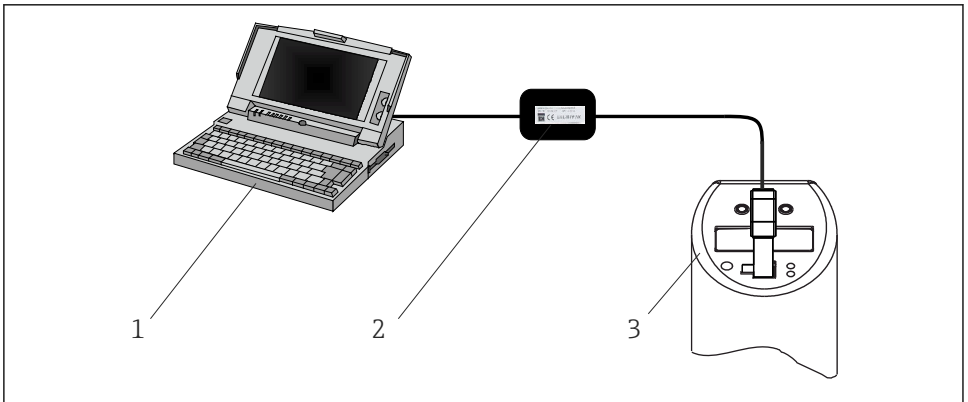

A0008072

#### 16 Operation, visualization and maintenance with PC and configuration software

- 1 PC with FieldCare configuration software
- 2 Configuration kit TXU10-AA or FXA291 with USB port
- 3 Flow switch

### 6.3.1 Additional operating options

In addition to the operating options listed in the previous "Local operation" section, further information about the device is available via the FieldCare configuration software:

Function group	Function (display)	Description
SERV (service)	Switching operations 1 Switching operations 2, optional	Number of changes in the switching state for switch output 1; optionally for switch output 2
INFO (device information)	TAG 1 TAG 2	Tagging, 18-digit
	Order code	Order code
	Device serial number	-
	Sensor serial number	-
	Electronics serial number	-
	Device version	Displays the overall device version
	Hardware revision	-
	Software revision	-

### 6.3.2 Notes on operation with FieldCare

FieldCare is a universal configuration and service software based on FDT/DTM technology.



The "PCP Communications DTM" and the Flowphant DeviceDTM are needed to configure the Flowphant T DTT31/35 with FieldCare.

This device supports offline operation and the transfer of parameters from and to the device. Online device operation is not supported.

Detailed information on FieldCare is provided in the associated Operating Instructions (BA027/S/c4) or at [www.endress.com](http://www.endress.com).

## 7 Diagnostics and troubleshooting

### 7.1 General troubleshooting

If an error occurs in the device, the color of the status LED changes from green to red and the lighting of the digital display from white to red. A flashing red/green status LED signals a warning. The display shows:

- An E-code in the event of errors  
The measured value is uncertain if an error occurs.
- A W-code in the event of warnings  
The measured value is reliable if warnings occur.

Code	Explanation	Remedy
E011	Device configuration is incorrect	Perform device reset → 📄 28
E012	Measurement error or medium temperature outside the measurable range	Check the medium temperature; return the device to the manufacturer if necessary
E013	Sensor heating defective	Return device to manufacturer
E019	Power supply out of specification	Check operating voltage
E015	Memory error	Return device to manufacturer
E020		
E021		
E022	Power is only supplied to the device via the communication interface (measurement is disabled)	Check operating voltage
E042	Output current can no longer be generated (only for 4 to 20 mA output, e.g. load too high at analog output or open analog output)	Check load; switch off analog output

Code	Explanation	Remedy
W107	Simulation active	
W200	Medium temperature out of specification (>85 °C)	Check the medium temperature and adapt it to the specification if necessary
W202	Measured flow outside the range between the set Low and High Flow (< -10% or >110%)	Set the High and Low Flow again; reset the device to the factory default setting if necessary (PRES function)
W209	Device starting up	
W210	Configuration changed (warning code is displayed for approx. 15 s)	
W240	Flow velocity too high (> 3 m/s in water), the device is being operated outside its specified measuring range. The measurement is uncertain.	Reduce the flow velocity of the medium
W250	Number of max. switching cycles exceeded	
W260	Values for High Flow (HIF) and Low Flow (LOWF) are too close together	Set the High and Low Flow again (values are further apart); reset the device to the factory default setting if necessary (PRES function)
W270	Short-circuit and overload at output 1	Check output wiring
W280	Short-circuit and overload at output 2	Check output wiring
W432	Values for High Flow (HIF) or Low Flow (LOWF) could not be determined with certainty. The device can still be operated, however. → 📄 20	Set the High and Low Flow again (keep flow velocity constant!)

## 7.2 Firmware history

### 7.2.1 Release

The release number on the nameplate and in the Operating Instructions indicates the device release: XX.YY.ZZ (example 01.02.01).

XX	<ul style="list-style-type: none"> <li>▪ Change to main version</li> <li>▪ No longer compatible</li> <li>▪ The device and Operating Instructions change</li> </ul>
YY	<ul style="list-style-type: none"> <li>▪ Change to functionality and operation</li> <li>▪ Compatible</li> <li>▪ No changes to the Operating Instructions</li> </ul>
ZZ	<ul style="list-style-type: none"> <li>▪ Fixes and internal changes</li> <li>▪ No changes to the Operating Instructions</li> </ul>

### 7.2.2 Software history

Date	Software version	Software modifications	Documentation	Material number
04.2014	01.00.08	-	BA00235R/09/EN/16.14	71252243
01.2014	01.00.08	-	BA00235R/09/EN/15.14	71243851
07.2013	01.00.08	-	BA00235R/09/EN/14.13	71226086
11.2008	01.00.04	-	BA235r/09/en/13.10	71098493
11.2008	01.00.04	-	BA235r/09/en/06.09	71098493
11.2008	01.00.04	Calibration function: variable setting for HIF (70 to 100%) and LOWF (0 to 20%); warning message W200	BA235r/09/en/11.08	71036990
12.2006	01.00.03	-	BA235r/09/en/10.07	71036990
12.2006	01.00.03	Analog output version (4 to 20 mA) available	BA235r/09/en/12.06	71036990
02.2006	01.00.00	Original firmware	BA218r/09/en/02.06	71022232



## 8 Maintenance

Buildup on the sensor negatively affects measurement accuracy

- ▶ Check the sensor for buildup at regular intervals.

### CAUTION

**Damage to the device.**

- ▶ Ensure that the process is unpressurized before you remove the device.
- ▶ Do not twist the device out of the process connection thread at the housing.
- ▶ Always use a suitable open-ended wrench to remove the device →  42.

### 8.1 Cleaning

The device must be cleaned whenever necessary. Cleaning can also be done when the device is installed (e.g. CIP Cleaning in Place / SIP Sterilization in Place). When cleaning the device, care must be taken to ensure that it is not damaged.

### NOTICE

**Avoid damage to the device and the system**

- ▶ Pay attention to the specific IP code when cleaning.

## 9 Repair

Repairs are not envisaged for the device.

### 9.1 Return

The requirements for safe device return can vary depending on the device type and national legislation.

1. Refer to the website for more information:  
<http://www.endress.com/support/return-material>
2. Return the device if repairs or a factory calibration are required, or if the wrong device was ordered or delivered.

### 9.2 Disposal

The device contains electronic components and must, therefore, be disposed of as electronic waste in the event of disposal. When disposing, comply with national disposal regulations, and separate and recycle the device components based on the materials.

## 10 Accessories

### 10.1 Device-specific accessories

#### 10.1.1 Welding boss with sealing taper

- Collar welding boss movable with sealing taper, washer and pressure screw  $G\frac{1}{2}$ "
- Material of parts in contact with the process: 316L, PEEK,
- Max. process pressure 10 bar (145 psi)
- Order number with pressure screw 51004751
- Order number without pressure screw 51004752

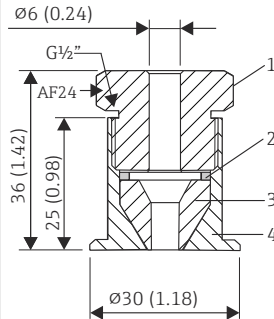

A0020709-EN

17 Dimensions in mm (in)

- 1 Pressure screw, 303/304
- 2 Washer, 303/304
- 3 Sealing taper, PEEK
- 4 Collar welding boss, 316L

#### 10.1.2 Collar welding boss

- Collar welding boss movable with sealing taper and washer
- Material of parts in contact with the process: 316L, PEEK
- Max. process pressure 10 bar (145 psi)
- Order number without pressure screw: 51004752

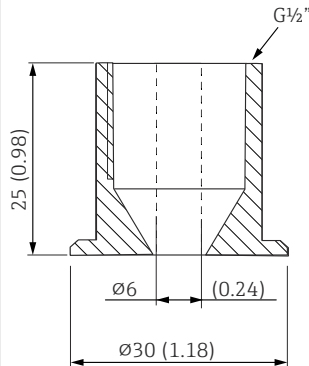

A0020710

18 Dimensions in mm (in)

### 10.1.3 Compression fitting

- Movable clamping ring, various process connections
- Material of compression fitting and parts in contact with the process: 316L
- Order number: TA50-..... (depending on the process connection)

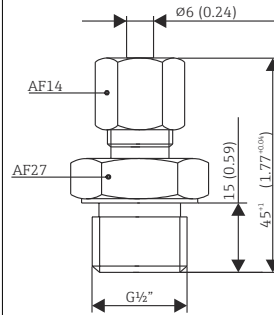

A0020174-EN

19 Dimensions in mm (in)

Version	F in mm (in)		L ~ in mm (in)	C in mm (in)	B in mm (in)	Clamping ring material	Max. process temperature	Max. process pressure
TA50	G $\frac{1}{2}$ "	SW/AF 27	47 (1.85)	-	15 (0.6)	SS316 <sup>1)</sup>	800 °C (1472 °F)	40 bar at 20 °C (580 psi at 68 °F)
						PTFE <sup>2)</sup>	200 °C (392 °F)	5 bar at 20 °C (72.5 psi at 68 °F)
	G $\frac{3}{4}$ "	SW/AF 32	63 (2.48)	-	20 (0.8)	SS316 <sup>1)</sup>	800 °C (1472 °F)	40 bar at 20 °C (580 psi at 68 °F)
						PTFE <sup>2)</sup>	200 °C (392 °F)	5 bar at 20 °C (72.5 psi at 68 °F)
	G1"	SW/AF 41	65 (2.56)	-	25 (0.98)	SS316 <sup>1)</sup>	800 °C (1472 °F)	40 bar at 20 °C (580 psi at 68 °F)
						PTFE <sup>2)</sup>	200 °C (392 °F)	5 bar at 20 °C (72.5 psi at 68 °F)
	NPT $\frac{1}{2}$ "	SW/AF 22	50 (1.97)	-	20 (0.8)	SS316 <sup>1)</sup>	800 °C (1472 °F)	40 bar at 20 °C (580 psi at 68 °F)

Version	F in mm (in)		L ~ in mm (in)	C in mm (in)	B in mm (in)	Clamping ring material	Max. process temperature	Max. process pressure
	R½"	SW/AF 22	52 (2.05)	-	20 (0.8)	PTFE <sup>2)</sup>	200 °C (392 °F)	5 bar at 20 °C (72.5 psi at 68 °F)
	R¾"	SW/AF 27	52 (2.05)	-	20 (0.8)	PTFE <sup>2)</sup>	200 °C (392 °F)	5 bar at 20 °C (72.5 psi at 68 °F)

- 1) SS316 clamping ring; can only be used once. Once released the compression fitting cannot be repositioned on the thermowell. Fully adjustable immersion length on initial installation
- 2) PTFE/Elastosil® clamping ring; reusable; once loosened, the compression fitting can be moved up or down on the thermowell. Fully adjustable immersion length

## 10.2 Communication-specific accessories

### 10.2.1 Coupling; connecting cable

- Coupling M12x1; straight
- Connection to M12x1 housing connector
- Materials: body PA, coupling nut CuZn, nickel-plated
- Degree of protection (connected): IP 67
- Order number: 52006263

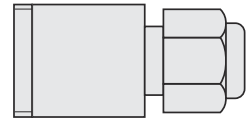
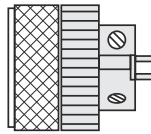

A0035843

- M12x1 coupling; elbowed, for termination of connecting cable by user
- Connection to M12x1 housing connector
- Materials: body PBT/PA,
- Coupling nut GD-Zn, nickel-plated
- Degree of protection (connected): IP 67
- Order number: 51006327

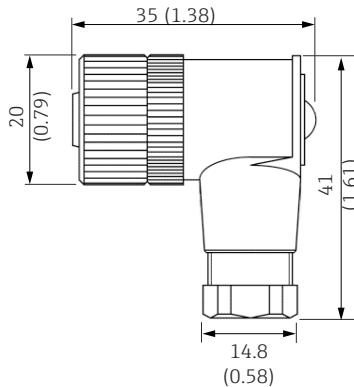

20 Dimensions in mm (in)

A0020722

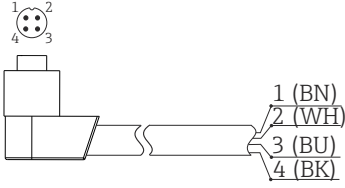
<ul style="list-style-type: none"> <li>■ PVC cable (terminated), 4 x 0.34 mm<sup>2</sup> with M12x1 coupling, elbowed, screw plug, length 5 m (16.4 ft)</li> <li>■ Degree of protection: IP67</li> <li>■ Order number: 51005148</li> </ul> <p>Core colors:</p> <ul style="list-style-type: none"> <li>■ 1 = BN brown</li> <li>■ 2 = WH white</li> <li>■ 3 = BU blue</li> <li>■ 4 = BK black</li> </ul>	 <p style="text-align: right;">A0020723</p>
--	--

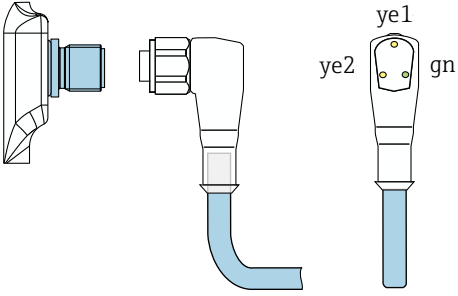
<ul style="list-style-type: none"> <li>■ PVC cable, 4x 0.34 mm<sup>2</sup> with M12x1 coupling, with LED, elbowed,</li> <li>■ 316L screw plug, length 5 m (16.4 ft), specially for hygiene applications,</li> <li>■ Degree of protection (connected): IP69K</li> <li>■ Order number: 52018763</li> </ul> <p>Display:</p> <ul style="list-style-type: none"> <li>■ gn: device is operational</li> <li>■ ye1: switch status 1</li> <li>■ ye2: switch status 2</li> </ul> <p> Not suitable for 4 to 20 mA analog output!</p>	 <p style="text-align: right;">A0035844</p>
--	---

## 10.2.2 Configuration kit

<ul style="list-style-type: none"> <li>■ Configuration kit for PC-programmable transmitters; Configuration software and interface cable for PC with USB port and 4-pin post connector Order code: TXU10-AA</li> <li>■ "Commubox FXA291" configuration kit with interface cable for PC with USB port. Intrinsically safe CDI interface (Endress+Hauser Common Data Interface) for transmitters with 4-pin post connector. Suitable configuration software is FieldCare for example. Order code: <b>FXA291</b></li> </ul>
---

## 10.2.3 Configuration software

The FieldCare 'Device Setup' configuration programs can be downloaded free of charge from the Internet at:

[www.produkte.endress.com/fieldcare](http://www.produkte.endress.com/fieldcare)

FieldCare 'Device Setup' can also be ordered from an Endress+Hauser sales office.

# 11 Technical data

## 11.1 Input

### 11.1.1 Measured variable

- Flow velocity of liquid media (calorimetric measuring principle)
- Temperature (RTD), optionally for two switch outputs or additional analog output

### 11.1.2 Measuring range

Flow	0.03 to 3 m/s (0.1 to 9.84 ft/s), as relative value between 0 to 100%; maximum display resolution: 1%
Temperature	-20 to +85 °C (-4 to +185 °F); display resolution: 1 °C (1 °F)

## 11.2 Output

### 11.2.1 Signal on alarm

Analog output: signal on alarm according to NAMUR NE43

Underranging	Linear drop to 3.8 mA
Overranging	Linear rise to 20.5 mA
Sensor breakage; sensor short-circuit	≤3.6 mA or ≥ 21.0 mA (output 21.7 mA is guaranteed for setting ≥ 21.0 mA)
Switch outputs	In the safe state (switch open)

### 11.2.2 Switching capacity

DC voltage version:

Switch status ON	$I_a \leq 250 \text{ mA}$
Switch status OFF	$I_a \leq 1 \text{ mA}$
Switching cycles	> 10,000,000
Voltage drop PNP	≤2 V
Overload protection	Switching current checked automatically; switched off in event of overcurrent, switching current checked again every 0.5 s; max. capacitive load: 14 µF for max. supply voltage (without resistive load); periodic disconnection from a protective circuit in event of overcurrent (f = 2 Hz) and "Warning" displayed

## 11.3 Power supply

### 11.3.1 Supply voltage

DC voltage version: 18 to 30 V<sub>DC</sub> (reverse polarity protection)

Behavior in the event of overvoltage (>30 V)

- The device works continuously up to  $34 V_{DC}$  without any damage
- No damage in event of transient overvoltage up to 1 kV (according to EN 61000-4-5)
- If the supply voltage is exceeded, the specified characteristics are no longer guaranteed

Behavior in the event of undervoltage

If the supply voltage falls below the minimum value, the device switches off in a defined manner (status as if not supplied with power = switch open)



The device may be powered only by a power supply unit that operates using a limited energy circuit in accordance with UL/EN/IEC 61010-1, Section 9.4 and the requirements in Table 18.

### 11.3.2 Current consumption

< 100 mA (no-load) at  $24 V_{DC}$ , max. 150 mA (no-load); with reverse polarity protection

## 11.4 Environment

### 11.4.1 Ambient temperature range

-40 to +85 °C (-40 to +185 °F)

### 11.4.2 Storage temperature

-40 to +85 °C (-40 to +185 °F)

### 11.4.3 Operating altitude

Up to 4 000 m (13 123.36 ft) above sea level

### 11.4.4 Degree of protection

IP65	M16 x 1.5 or NPT ½", valve connector
IP66	M12 x 1 connector

### 11.4.5 Shock resistance

50 g as per DIN IEC 68-2-27 (11 ms)

### 11.4.6 Vibration resistance

- 20 g as per DIN IEC 68-2-6 (10-2000 Hz)
- 4 g as per marine approval

### 11.4.7 Electromagnetic compatibility (EMC)

EMC to all relevant requirements of the IEC/EN 61326-series and NAMUR Recommendation EMC (NE21). For details, refer to the Declaration of Conformity.

Maximum fluctuations during EMC-tests: < 1 % of measuring span.

Interference immunity to IEC/EN 61326-series, requirements for industrial areas

Interference emission to IEC/EN 61326-series, electrical equipment Class B

### 11.4.8 Electrical safety

- Protection class III
- Overvoltage category II
- Pollution level 2

## 11.5 Process

### 11.5.1 Process temperature range

-20 to +85 °C (-4 to +185 °F)

The sensor can be exposed to process temperatures up to 130 °C (266 °F) without being damaged. The monitoring system switches off automatically at  $T \geq 85 \text{ °C}$  (185 °F) and starts again at  $T \leq 85 \text{ °C}$  (185 °F).

### 11.5.2 Process pressure range

Maximum permissible process pressure  $P_{\max} \leq 10 \text{ MPa} = 100 \text{ bar}$  (1 450 psi)

 The maximum process pressure for the conical metal-metal process connection (MB option) for the device is 1.6 MPa = 16 bar (232 psi).

### 11.5.3 Flow limit

Liquids: 0 to 3.0 m/s (0 to 9.84 ft/s)

### 11.5.4 Operational range

Liquids: 0.03 to 3.0 m/s (0.1 to 9.84 ft/s)



## 11.6 Mechanical construction

### 11.6.1 Design, dimensions

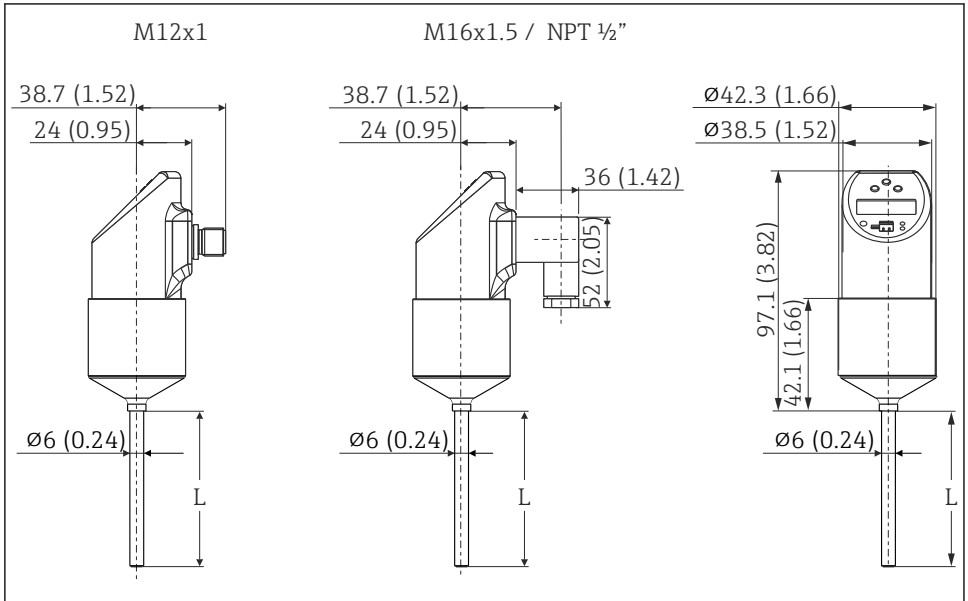

A0005279

All dimensions in mm (in)

L = insertion length

M12x1 connector as per IEC 60947-5-2

Valve connector M16x1.5 or NPT 1/2" as per DIN 43650A/ISO 4400

### 11.6.2 DTT31 design, dimensions of process connections

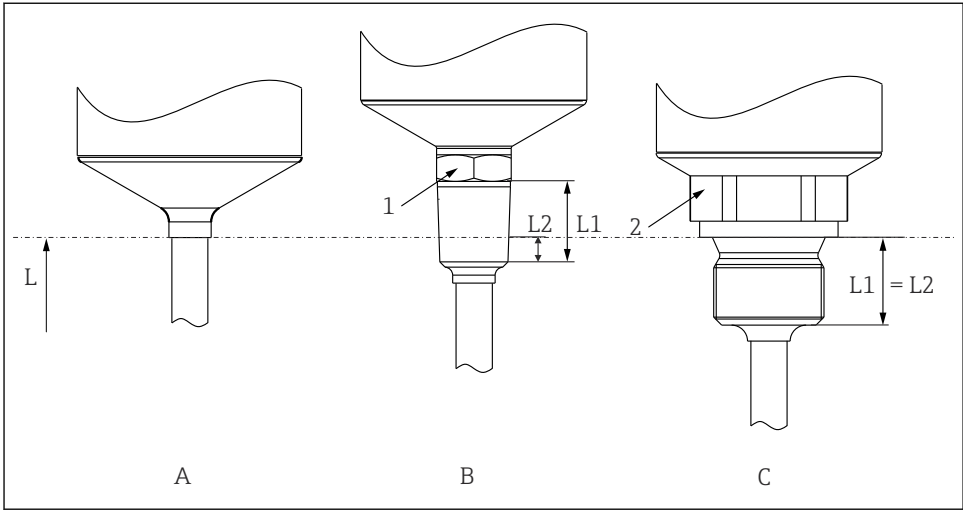

A0007101

21 Process connection versions

L Insertion length

Item no.	Version	Thread length $L_1$	Screw-in length $L_2$
A	Without process connection. Suitable welding bosses and compression fittings. → 34	-	-
B	Threaded process connection: ANSI NPT 1/4" (1 = AF14) ANSI NPT 1/2" (1 = AF27)	<ul style="list-style-type: none"> <li>■ 14.3 mm (0.56 in)</li> <li>■ 19 mm (0.75 in)</li> </ul>	<ul style="list-style-type: none"> <li>■ 5.8 mm (0.23 in)</li> <li>■ 8.1 mm (0.32 in)</li> </ul>
C	Threaded process connection, inches, cylindrical as per ISO 228: G1/4" (2 = AF14) G1/2" (2 = AF27)	<ul style="list-style-type: none"> <li>■ 12 mm (0.47 in)</li> <li>■ 14 mm (0.55 in)</li> </ul>	-

### 11.6.3 DTT35 design, dimensions of process connections

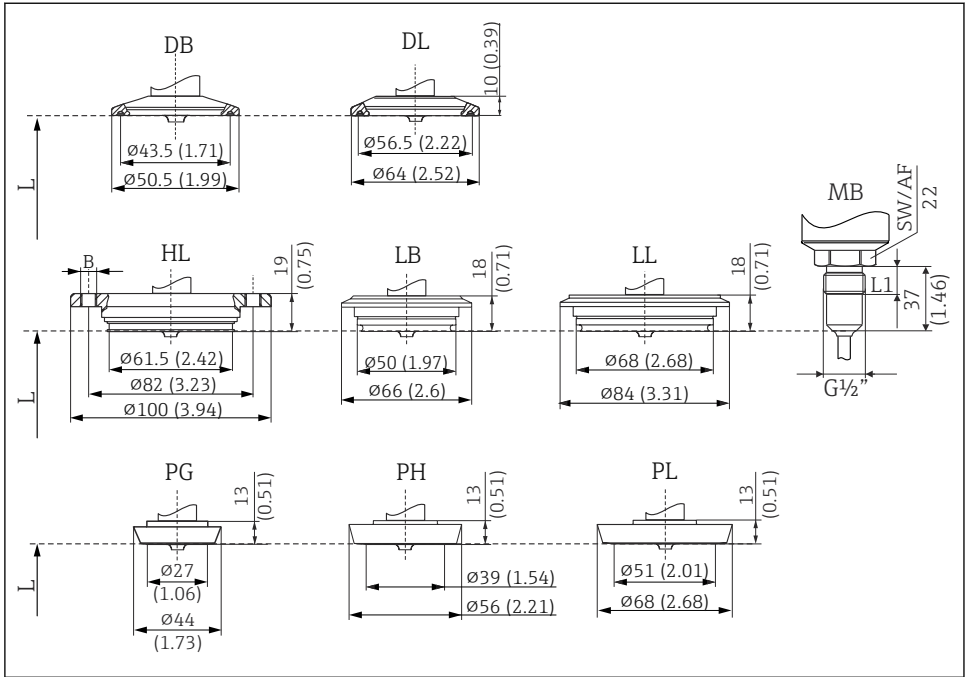

A0011776

#### 22 Process connection versions

All dimensions in mm (in).  
 $L$  = insertion length  $L$

Item no.	Process connection versions DTT35	Hygiene standard
DB	Clamp 1" to 1½" (ISO 2852) or DN 25 to 40 (DIN 32676)	3-A marked and EHEDG certified (only in conjunction with self-centering seal according to EHEDG position paper)
DL	Clamp 2" (ISO 2852) or DN 50 (DIN 32676)	
HL	APV Inline, DN50, PN40, 316L, B = bores 6 x $\varnothing 8.6$ mm (0.34 in) + 2 x M8 thread	With 3-A symbol and EHEDG certification
LB	Varivent F DN25-32, PN 40, 316L	
LL	Varivent N DN40-162, PN 40, 316L	
MB	Metal sealing system for hygienic processes, $G\frac{1}{2}''$ thread, thread length L1 = 14 mm (0.55 in). Suitable welding boss available as an accessory. 316L	-

Item no.	Process connection versions DTT35	Hygiene standard
PG	DIN 11851, DN25, PN40 (including coupling nut), 316L	3-A marked and EHEDG certified (only in conjunction with self-centering seal according to EHEDG position paper)
PH	DIN 11851, DN40, PN40 (including coupling nut), 316L	
PL	DIN 11851, DN50, PN40 (including coupling nut), 316L	

 The VARINLINE® housing connection flange is suitable for welding into the conical or torispherical head in tanks or vessels with a small diameter ( $\leq 1.6$  m (5.25 ft)) and up to a wall thickness of 8 mm (0.31 in). The Varivent type F cannot be used for installations in pipes in combination with the VARINLINE housing connection flange.

### 11.6.4 Weight

approx. 300 g (10.58 oz), depends on process connection and sensor length

### 11.6.5 Materials

- Process connection AISI 316L  
Surfaces in contact with the process in hygienic version with surface quality  $R_a \leq 0.76 \mu\text{m}$  (30  $\mu\text{in}$ )
- Coupling nut AISI 304
- AISI 316L housing, with surface quality  $R_a \leq 0.76 \mu\text{m}$  (30  $\mu\text{in}$ )  
O-ring between housing and sensor module: EPDM
- Electrical connection
  - M12 connector, exterior AISI 316L, interior polyamide (PA)
  - Valve connector, polyamide (PA)
  - M12 connector, exterior 316L
  - Cable sheath polyurethane (PUR)
  - O-ring between electrical connection and housing: FKM
- Display, polycarbonate PC-FR (Lexan®)  
Seal between display and housing: SEBS THERMOPLAST K®  
Keys, polycarbonate PC-FR (Lexan®)

## 11.7 Certificates and approvals

### 11.7.1 CE mark

The product meets the requirements of the harmonized European standards. As such, it complies with the legal specifications of the EC directives. The manufacturer confirms successful testing of the product by affixing to it the CE-mark.



### 11.7.2 Other standards and guidelines

- IEC 60529:  
Degrees of protection provided by enclosures (IP code)
- IEC/EN 61010-1:  
Protection Measures for Electrical Equipment for Measurement, Control, Regulation and Laboratory Procedures
- IEC/EN 61326 series:  
Electromagnetic compatibility (EMC requirements)
- NAMUR:  
International user association of automation technology in process industries  
(www.namur.de)
- NEMA:  
United States National Electrical Manufacturers Association.

### 11.7.3 UL approval

More information under UL Product iq™, search for keyword "E225237")

### 11.7.4 Hygiene standard

- EHEDG certification, type EL CLASS I. EHEDG certified/tested process connections →  42
- 3-A Authorization No. 1144, 3-A Sanitary Standard 74-07. Listed process connections →  43

### 11.7.5 Materials in contact with food/product (FCM)

The materials of the thermometer in contact with food/product (FCM) comply with the following European regulations:

- (EC) No. 1935/2004, Article 3, Paragraph 1, Articles 5 and 17 on materials and articles intended to come into contact with food.
- (EC) No. 2023/2006 on good manufacturing practice (GMP) for materials and articles intended to come into contact with food.
- (EC) No. 10/2011 on plastic materials and articles intended to come into contact with food.
- All surfaces in contact with the medium are free from materials derived from bovine animals or other livestock (ADI/TSE)

### 11.7.6 Schiffbauzulassung

Information on the Type Approval Certificates currently available (DNVGL, BV, etc.) can be obtained from the sales organization.

### 11.7.7 Material certification

The material certificate 3.1 (according to standard EN 10204) can be requested separately. The "short form" certificate includes a simplified declaration with no enclosures of documents related to the materials used in the construction of the single sensor and guarantees the traceability of the materials through the identification number of the thermometer. The data related to the origin of the materials can subsequently be requested by the client if necessary.

## 11.8 Supplementary documentation

### 11.8.1 Technical Information

- Easy Analog RNB130: TI120R/09/en
- Process display unit RIA452: TI113R/09/en
- Universal data manager Ecograph T: TI01079R/09/en
- Data logger Minilog B: TI089R/09/en

### 11.8.2 Operating Instructions

Flow switch Flowphant T DTT31, DTT35: BA00235R/09/en





71509929

[www.addresses.endress.com](http://www.addresses.endress.com)

---