

Operating Instructions

iTEMP TMT86

Dual-input temperature transmitter
PROFINET® protocol



Table of contents

1	About this document	4	9	Commissioning	36
1.1	Symbols	4	9.1	Installation check	36
1.2	Tool symbols	5	9.2	Switching on the device	36
1.3	Documentation	5	9.3	Configuring the device address via software ..	36
1.4	Registered trademarks	6	9.4	Device configuration	36
2	Safety instructions	7	9.5	Simulation	40
2.1	Requirements for personnel	7	9.6	Protecting settings from unauthorized access .	40
2.2	Intended use	7	10	Operation	42
2.3	Workplace safety	7	10.1	Reading off the device locking status	42
2.4	Operational safety	7	10.2	Reading off measured values	42
2.5	Product safety	8	10.3	Adapting the measuring device to the process conditions	42
2.6	IT security	8	11	Diagnostics and troubleshooting ...	43
2.7	Device-specific IT security	8	11.1	General troubleshooting	43
3	Product description	9	11.2	Diagnostic information on local display	45
4	Incoming acceptance and product identification	9	11.3	Diagnostic information via communication interface	45
4.1	Incoming acceptance	9	11.4	Overview of diagnostic events	46
4.2	Product identification	9	11.5	Event logbook	48
4.3	Certificates and approvals	10	11.6	Thermowell monitoring with second process seal (dual seal)	49
4.4	Storage and transport	10	11.7	Firmware history	49
5	Installation	10	12	Maintenance	49
5.1	Mounting requirements	10	13	Repair	49
5.2	Mounting the measuring device	11	13.1	General information	49
5.3	Post-mounting check	14	13.2	Spare parts	49
6	Electrical connection	15	13.3	Return	50
6.1	Connecting requirements	15	13.4	Disposal	50
6.2	Connecting the measuring device	15	14	Accessories	50
6.3	Connecting the sensor cables	17	14.1	Device-specific accessories	50
6.4	Ensuring the degree of protection	19	14.2	Communication-specific accessories	51
6.5	Post-connection check	19	14.3	Service-specific accessories	51
7	Operation options	20	15	Technical data	52
7.1	Overview of operation options	20	15.1	Function and system design	52
7.2	Structure and function of the operating menu	23	15.2	Input	54
7.3	Access to operating menu via web browser ...	25	15.3	Output	55
7.4	Access to the operating menu via operating tools	29	15.4	Performance characteristics	56
8	System integration	31	15.5	Environment	62
8.1	Overview of device description files	31	15.6	Mechanical construction	63
8.2	Overview of system files	31	15.7	Operability	66
8.3	Cyclic data transmission	32	15.8	Certificates and approvals	67
			15.9	Ordering information	67
			15.10	Supplementary documentation	68
			Index		69

1 About this document

1.1 Symbols

1.1.1 Safety symbols

DANGER

This symbol alerts you to a dangerous situation. Failure to avoid this situation will result in serious or fatal injury.

WARNING

This symbol alerts you to a dangerous situation. Failure to avoid this situation can result in serious or fatal injury.





CAUTION

This symbol alerts you to a dangerous situation. Failure to avoid this situation can result in minor or medium injury.







NOTICE







This symbol contains information on procedures and other facts which do not result in personal injury.

1.1.2 Electrical symbols





Symbol	Meaning
	Direct current
	Alternating current
	Direct current and alternating current
	Ground connection A grounded terminal which, as far as the operator is concerned, is grounded via a grounding system.
	Potential equalization connection (PE: protective earth) Ground terminals that must be connected to ground prior to establishing any other connections. The ground terminals are located on the interior and exterior of the device: <ul style="list-style-type: none"> ▪ Interior ground terminal: potential equalization is connected to the supply network. ▪ Exterior ground terminal: device is connected to the plant grounding system.

1.1.3 Symbols for certain types of information



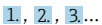

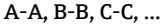
Symbol	Meaning
	Permitted Procedures, processes or actions that are permitted.
	Preferred Procedures, processes or actions that are preferred.
	Forbidden Procedures, processes or actions that are forbidden.
	Tip Indicates additional information.
	Reference to documentation
	Reference to page

Symbol	Meaning
	Reference to graphic
	Notice or individual step to be observed
	Series of steps
	Result of a step
	Help in the event of a problem
	Visual inspection

1.1.4 Symbols in graphics

Symbol	Meaning	Symbol	Meaning
	Item numbers		Series of steps
	Views		Sections
	Hazardous area		Safe area (non-hazardous area)

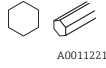
1.2 Tool symbols

Symbol	Meaning
 A0011220	Flat-blade screwdriver
 A0011219	Phillips head screwdriver
 A0011221	Allen key
 A0011222	Open-ended wrench
 A0013442	Torx screwdriver

1.3 Documentation

Document	Purpose and content of the document
Technical Information (TI)	Planning aid for your device The document contains all the technical data on the device and provides an overview of the accessories and other products that can be ordered for the device.
Brief Operating Instructions (KA)	Guide that takes you quickly to the 1st measured value The Brief Operating Instructions contain all the essential information from incoming acceptance to initial commissioning.
Operating Instructions (BA)	Your reference document The Operating Instructions contain all the information that is required in various phases of the life cycle of the device: from product identification, incoming acceptance and storage, to mounting, connection, operation and commissioning through to troubleshooting, maintenance and disposal.

Document	Purpose and content of the document
Description of Device Parameters (GP)	Reference for your parameters The document provides a detailed explanation of each individual parameter. The description is aimed at those who work with the device over the entire life cycle and perform specific configurations.
Safety Instructions (XA)	Depending on the approval, Safety Instructions (XA) are supplied with the device. The Safety Instructions are an integral part of the Operating Instructions.  Information on the Safety Instructions (XA) that are relevant for the device is provided on the nameplate.
Supplementary device-dependent documentation (SD/FY)	Additional documents are supplied depending on the device version ordered: Always comply strictly with the instructions in the supplementary documentation. The supplementary documentation is an integral part of the device documentation.

-  The document types listed are available:
- In the Download Area of the Endress+Hauser Internet site: www.endress.com → Download
 - Enter the serial number from the nameplate in the W@M Device Viewer (www.endress.com/deviceviewer): all data relating to the device and an overview of the Technical Documentation supplied with the device are displayed.
 - Enter the serial number on the nameplate into the Endress+Hauser Operations app or scan the 2-D matrix code (QR code) on the nameplate with the Endress+Hauser Operations app: all data relating to the device and the Technical Documentation pertaining to the device is displayed.

1.4 Registered trademarks

PROFINET®

Registered trademark of the PROFIBUS Nutzerorganisation e.V. (PROFIBUS User Organization), Karlsruhe, Germany

2 Safety instructions

2.1 Requirements for personnel

The personnel for installation, commissioning, diagnostics and maintenance must fulfill the following requirements:

- ▶ Trained, qualified specialists must have a relevant qualification for this specific function and task.
- ▶ Personnel must be authorized by the plant owner/operator.
- ▶ Be familiar with federal/national regulations.
- ▶ Before starting work: personnel must read and understand the instructions in the manual and supplementary documentation as well as the certificates (depending on the application).
- ▶ Personnel must follow instructions and comply with general policies.

The operating personnel must fulfill the following requirements:

- ▶ Personnel are instructed and authorized according to the requirements of the task by the facility's owner-operator.
- ▶ Personnel follow the instructions in this manual.

2.2 Intended use

The device is a universal and user-configurable temperature transmitter with either one or two sensor inputs for a resistance thermometer (RTD), thermocouples (TC), resistance and voltage transmitters. The head transmitter version of the device is intended for mounting in a terminal head (flat face) as per DIN EN 50446. It is also possible to mount the device on a DIN rail using the optional DIN rail clip.

If the device is used in a manner not specified by the manufacturer, the protection provided by the device may be impaired.

The manufacturer is not liable for damage caused by improper or non-intended use.

 The head transmitter must not be operated as a DIN rail substitute in a cabinet by using the DIN rail clip with remote sensors.

2.3 Workplace safety

When working on and with the device:

- ▶ Wear the required personal protective equipment as per national regulations.

2.4 Operational safety

- ▶ Operate the device only if it is in proper technical condition, free from errors and faults.
- ▶ The operator is responsible for the interference-free operation of the device.

Hazardous area

To eliminate a danger for persons or for the facility when the device is used in the hazardous area (e.g. explosion protection or safety equipment):

- ▶ Based on the technical data on the nameplate, check whether the ordered device is permitted for the intended use in the hazardous area. The nameplate can be found on the side of the transmitter housing.
- ▶ Observe the specifications in the separate supplementary documentation that is an integral part of these instructions.

Device safety and electromagnetic compatibility

The measuring system complies with the general safety requirements and EMC requirements of the IEC/EN 61326 series and the APL EMC Test Specification.

2.5 Product safety

This product is designed in accordance with good engineering practice to meet state-of-the-art safety requirements and has been tested and left the factory in a condition in which it is safe to operate.

2.6 IT security

Our warranty is valid only if the product is installed and used as described in the Operating Instructions. The product is equipped with security mechanisms to protect it against any inadvertent changes to the settings.

IT security measures, which provide additional protection for the product and associated data transfer, must be implemented by the operators themselves in line with their security standards.

2.7 Device-specific IT security

The device offers specific functions to support protective measures by the operator. These functions can be configured by the user and guarantee greater in-operation safety if used correctly. The device provides a password for changing the user role (applies to operation via web server, FieldCare, DeviceCare, PDM).

Function/interface	Factory setting	Recommendation
Password (also applies for web server login or FieldCare connection)	Not enabled (0000)	Assign a customized access code during commissioning.
Web server	Enabled	On an individual basis following risk assessment.
Service interface (CDI)	Enabled	On an individual basis following risk assessment.
Write protection via hardware write protection switch	Not enabled	On an individual basis following risk assessment.

2.7.1 Protecting access via a password

Different passwords are available to protect write access to the parameters of the device.

User-specific password

Write access to the device parameters via the web browser or operating tool (e.g. FieldCare, DeviceCare) can be protected by the modifiable, user-specific password.

When the device is delivered, the device does not have an access code and is equivalent to 0000 (open).

General notes on the use of passwords

- During commissioning, any passwords that were used at delivery should be changed.
- Follow the general rules for generating a secure password when defining and managing the password.
- The user is responsible for the management and careful handling of passwords.
- For information on how to configure the access code or on the action to take if the password is lost, for example, please refer to the "Write protection via access code" section

2.7.2 Access via web server

The web server is enabled when the device is delivered. The web server can be disabled via the **Web server functionality** parameter if necessary (e.g. after commissioning).

The device and status information can be hidden on the login page. This prevents unauthorized access to the information.



For detailed information on device parameters, see: "Description of Device Parameters" document

3 Product description

The temperature transmitter is a 2-wire device with two measuring inputs. The device not only transfers converted signals from resistance thermometers and thermocouples, it also transfers resistance and voltage signals using PROFINET® communication. The device is powered via 2-wire Ethernet (Single Pair Ethernet) and the transmitter can be installed as an intrinsically safe apparatus in Zone 1 hazardous areas. The device is used for instrumentation purposes in the terminal head, form B (flat face), according to DIN EN 50446. Data transfer is via 5 Analog Input (AI) function blocks.

4 Incoming acceptance and product identification

4.1 Incoming acceptance

1. Unpack the temperature transmitter carefully. Are the contents or packaging undamaged?
 - ↳ Do not install damaged components, as otherwise the manufacturer cannot guarantee the material resistance or ensure compliance with the original safety requirements, and therefore cannot be held responsible for any resulting damage.
2. Is the delivery complete or is anything missing? Check the scope of delivery against your order.
3. Does the nameplate match the order information on the delivery note?
4. Are the technical documentation and all other necessary documents provided? If applicable: are the Safety Instructions (e.g. XA) for hazardous areas provided?



If one of these conditions is not met, please contact the manufacturer's sales office.

4.2 Product identification

The following options are available for identification of the device:

- Nameplate specifications
- Extended order code with breakdown of the device features on the delivery note
- Enter the serial number from the nameplate in the *W@M Device Viewer* (www.endress.com/deviceviewer): all data relating to the device and an overview of the Technical Documentation supplied with the device are displayed.
- Enter the serial number on the nameplate into the *Endress+Hauser Operations App* or scan the 2-D matrix code (QR code) on the nameplate with the *Endress+Hauser Operations App*: all the information about the device and the technical documentation pertaining to the device is displayed.

4.2.1 Nameplate

Do you have the correct device?

Compare and check the information on the nameplate of the device against the requirements of the measuring point.

Information on the nameplate:

- APL port profile (specifies device type, as well as voltage supply and power consumption)
- Serial number, device revision, firmware version and hardware version
- Data Matrix 2D code
- 2 lines for the TAG name and extended order code
- Approval in hazardous area with number of the relevant Ex documentation (XA...)
- Approvals with symbols

4.2.2 Name and address of manufacturer

Name of manufacturer:	Endress+Hauser Wetzler GmbH + Co. KG
Model/type reference:	TMT86
Address of manufacturer:	Obere Wank 1, D-87484 Nesselwang or www.endress.com

4.3 Certificates and approvals

 For certificates and approvals valid for the device: see the data on the nameplate

 Approval-related data and documents: www.endress.com/deviceviewer → (enter the serial number)

4.4 Storage and transport

Storage temperature: -52 to +100 °C (-61.6 to +212 °F)

Humidity

- Condensation permitted with head transmitter
- Max. rel. humidity: 95 % as per IEC 60068-2-30

 Pack the device for storage and transportation in such a way that it is reliably protected against impact and external influences. The original packaging provides optimum protection.

Avoid the following environmental influences during storage and transport:

- Direct sunlight
- Vibration
- Aggressive media

5 Installation

5.1 Mounting requirements

5.1.1 Dimensions

The dimensions of the device are provided in the "Technical data" section .

5.1.2 Mounting location

- In the terminal head, flat face, as per DIN EN 50446, direct mounting on insert with cable entry (middle hole 7 mm)
- In the field housing, separated from the process (see "Accessories" section)

i It is also possible to mount the head transmitter on a DIN rail as per IEC 60715 using the DIN rail clip accessory (see "Accessories" section).

Information about the conditions (such as the ambient temperature, degree of protection, climate class, etc.) that must be present at the installation point so that the device can be mounted correctly is provided in the "Technical data" section .

For use in hazardous areas, the limit values specified on the certificates and approvals must be observed (see Ex Safety Instructions).

5.2 Mounting the measuring device

A Phillips head screwdriver is required to mount the device:

- Maximum torque for securing screws = 1 Nm (3/4 foot-pound), screwdriver: Pozidriv Z2
- Maximum torque for screw terminals = 0.35 Nm (1/4 foot-pound), screwdriver: Pozidriv Z1

5.2.1 Head transmitter mounting

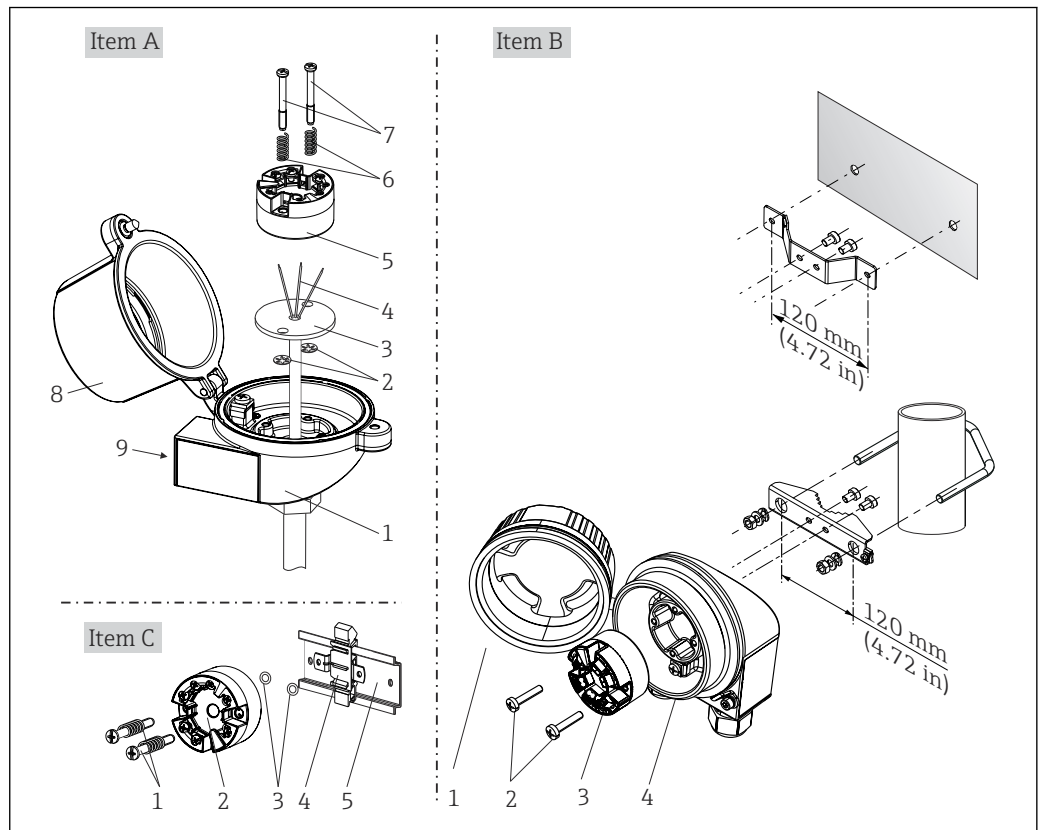

1 Head transmitter mounting (three versions)

Item A	Mounting in a terminal head (terminal head flat face as per DIN 43729)
1	Terminal head
2	Circlips
3	Insert

Item A	Mounting in a terminal head (terminal head flat face as per DIN 43729)
4	Connection wires
5	Head transmitter
6	Mounting springs
7	Mounting screws
8	Terminal head cover
9	Cable entry

Procedure for mounting in a terminal head, item A:

1. Open the terminal head cover (8) on the terminal head.
2. Guide the connection wires (4) of the insert (3) through the center hole in the head transmitter (5).
3. Fit the mounting springs (6) on the mounting screws (7).
4. Guide the mounting screws (7) through the side boreholes of the head transmitter and the insert (3). Then fix both mounting screws with the snap rings (2).
5. Then tighten the head transmitter (5) along with the insert (3) in the terminal head.
6. When the wiring is complete, close the terminal head cover (8) tightly again.

Item B	Mounting in a field housing
1	Field housing cover
2	Mounting screws with springs
3	Head transmitter
4	Field housing

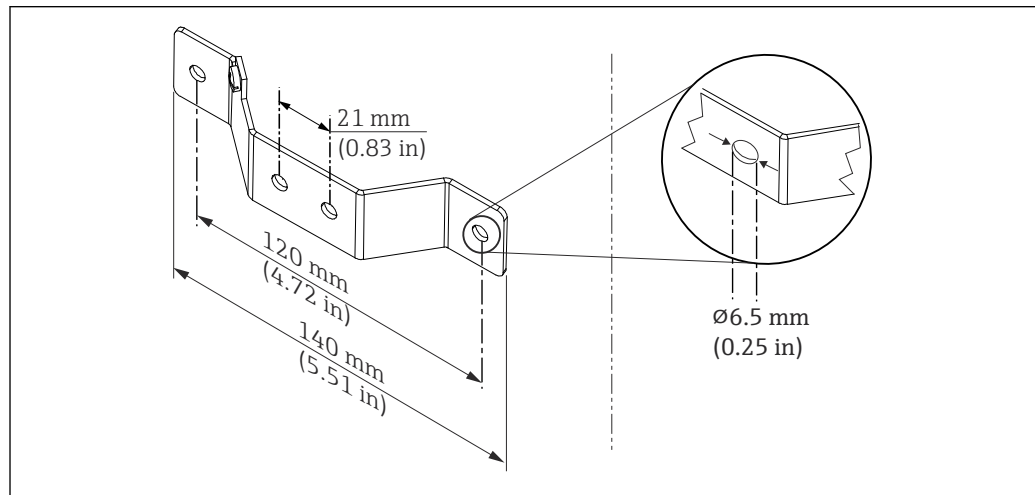

2 Dimensions of angle bracket for wall mount (complete wall mounting set available as accessory)

Procedure for mounting in a field housing, item B:

1. Open the cover (1) of the field housing (4).
2. Guide the mounting screws (2) through the lateral bores in the head transmitter (3).
3. Screw the head transmitter to the field housing.
4. When the wiring is complete, close the field housing cover (1) again.

Item C	Mounting on DIN rail (DIN rail as per IEC 60715)
1	Mounting screws with springs
2	Head transmitter
3	Circlips
4	DIN rail clip
5	DIN rail

Procedure for mounting on a DIN rail, item C:

1. Press the DIN rail clip (4) onto the DIN rail (5) until it engages with a click.
2. Fit the mounting springs on the mounting screws (1) and guide the screws through the side boreholes of the head transmitter (2). Then fix both mounting screws with the snap rings (3).
3. Screw the head transmitter (2) onto the DIN rail clip (4).

Mounting typical of North America

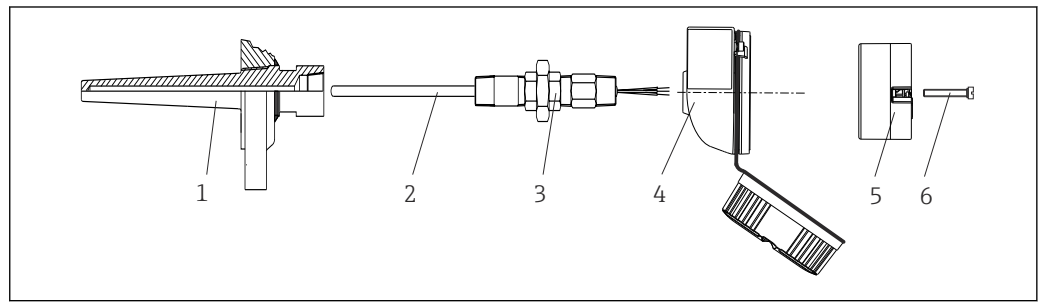

3 Head transmitter mounting

- 1 Thermowell
- 2 Insert
- 3 Adapter, coupling
- 4 Terminal head
- 5 Head transmitter
- 6 Mounting screws

Thermometer design with thermocouples or RTD sensors and head transmitter:

1. Fit the thermowell (1) on the process pipe or the container wall. Secure the thermowell according to the instructions before the process pressure is applied.
2. Fit the necessary neck tube nipples and adapter (3) on the thermowell.
3. Make sure sealing rings are installed if such rings are needed for harsh environmental conditions or special regulations.
4. Guide the mounting screws (6) through the lateral bores of the head transmitter (5).
5. Position the head transmitter (5) in the terminal head (4) in such a way that the bus cable (terminals 1 and 2) point to the cable entry.
6. Using a screwdriver, screw down the head transmitter (5) in the terminal head (4).
7. Guide the connection wires of the insert (3) through the lower cable entry of the terminal head (4) and through the middle hole in the head transmitter (5). Connect the connection wires to the transmitter.
8. Screw the terminal head (4), with the integrated and wired head transmitter, onto the ready-mounted nipple and adapter (3).

NOTICE

The terminal head cover must be secured properly to meet the requirements for explosion protection.

- ▶ After wiring, securely screw the terminal head cover back on.

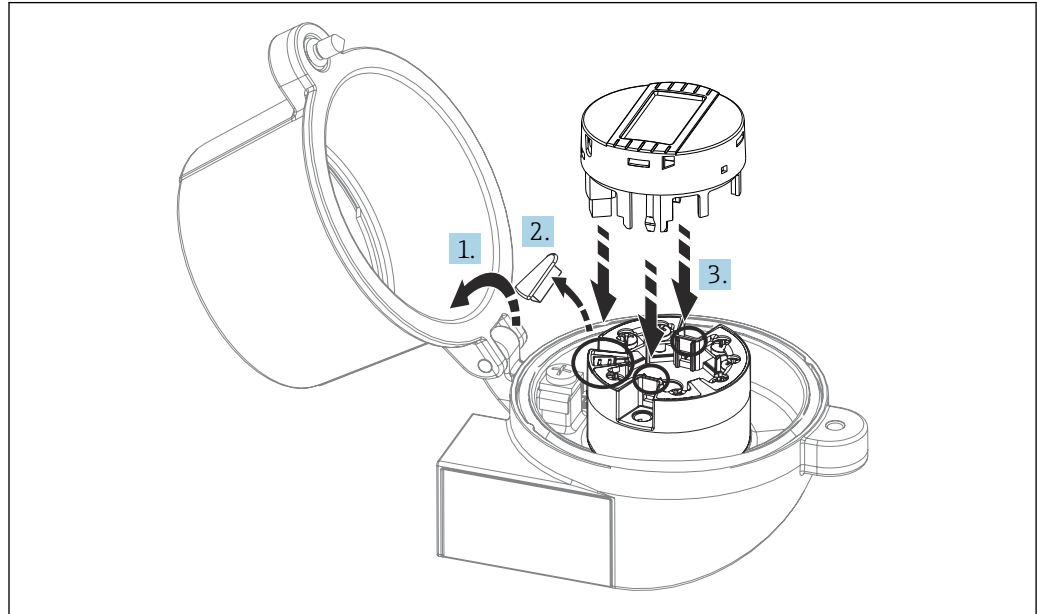
Mounting the display on the head transmitter

 4 Mounting the display

A0009852

1. Loosen the screw on the terminal head cover. Flip back the terminal head cover.
2. Remove the cover of the display connection area.
3. Fit the display module onto the mounted and wired head transmitter. The fastening pins must click securely into place on the head transmitter. After mounting, securely tighten the terminal head cover.

 The display can be used only with the appropriate terminal heads - cover with viewing window (e.g. TA30 from Endress+Hauser).

5.3 Post-mounting check

After installing the device, run the following final checks:

Device health and specifications	Notes
Is the device undamaged (visual inspection)?	-
Do the ambient conditions match the device specification (e.g. ambient temperature, measuring range, etc.)?	See "Technical data" section"

6 Electrical connection

6.1 Connecting requirements

A Phillips head screwdriver is required to wire the head transmitter with screw terminals. No tools are required for the version with push-in terminals.

⚠ CAUTION

- ▶ Switch off the power supply before installing or connecting the device. Failure to observe this may result in the destruction of parts of the electronics.
- ▶ When connecting Ex-certified devices, please take special note of the instructions and connection schematics in the Ex-specific supplement to these Operating Instructions.
- ▶ Do not occupy the display connection. An incorrect connection can destroy the electronics.
- ▶ Before connecting the power supply, connect the potential equalization line to the external ground terminal.
- ▶ The device may only be powered by a power unit with an energy-limited circuit in accordance with UL/EN/IEC 61010-1, Section 9.4 and the requirements of Table 18.

6.2 Connecting the measuring device

Head transmitter:

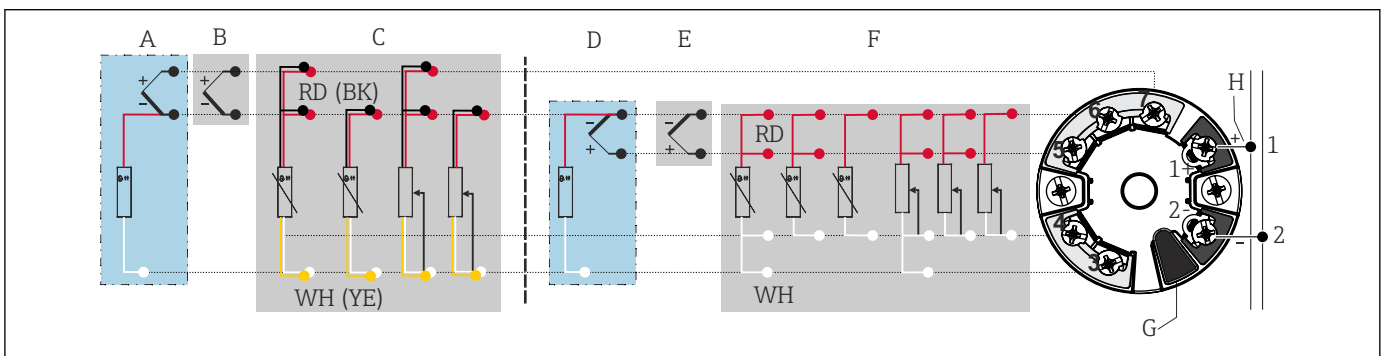

5 Assignment of terminal connections for head transmitter

- A Sensor input 2, TC and mV, external cold junction (CJ) Pt1000
- B Sensor input 2, TC and mV, internal cold junction (CJ)
- C Sensor input 2, RTD and Ω , 2- and 3-wire
- D Sensor input 1, TC and mV, external cold junction (CJ) Pt1000
- E Sensor input 1, TC and mV, internal cold junction (CJ)
- F Sensor input 1, RTD and Ω , 2-, 3- and 4-wire
- G Display connection, service interface
- H Bus connection and power supply

NOTICE

- ▶ ⚡ ESD - Electrostatic discharge. Protect the terminals from electrostatic discharge. Failure to observe this may result in the destruction or malfunction of parts of the electronics.

6.2.1 Fieldbus connection

Devices can be connected to the fieldbus in two ways:

- via conventional cable gland →  16
- via fieldbus connector

Risk of damage

- Switch off the power supply before installing or connecting the head transmitter. Failure to observe this may result in the destruction of parts of the electronics.
- Grounding via one of the grounding screws (terminal head, field housing) is recommended.
- If the shielding of the fieldbus cable is grounded at more than one point in systems without additional potential equalization, mains-frequency equalizing currents may occur and cause damage to the cable or shielding. In such cases, the shielding of the fieldbus cable should be grounded on one side only, i.e. it must not be connected to the ground terminal of the housing (terminal head, field housing). The shield that is not connected should be insulated!
- We recommend that the fieldbus not be looped using conventional cable glands. If you replace even just one measuring device at a later date, the bus communication will have to be interrupted.

Cable gland or entry

Please also follow the general procedure on →  15.

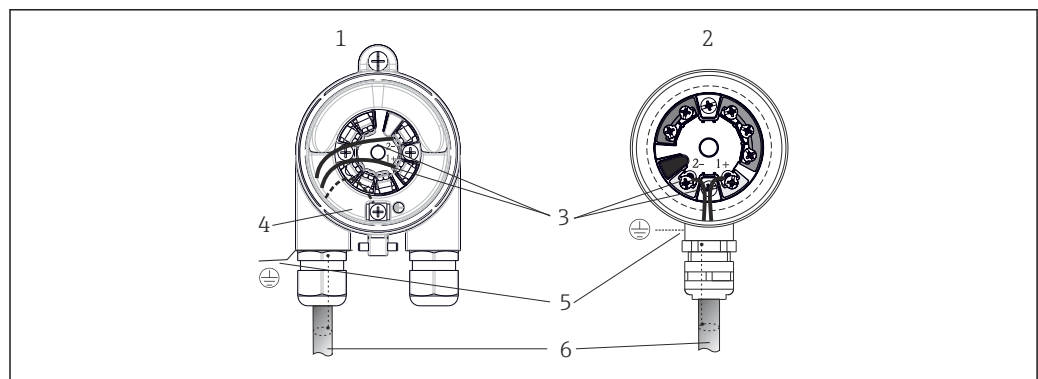

 6 Connecting the signal cables and power supply

- 1 Head transmitter installed in field housing
- 2 Head transmitter installed in terminal head
- 3 Terminals for fieldbus communication and power supply
- 4 Internal ground connection
- 5 External ground connection
- 6 Shielded fieldbus cable

Terminals

Choice of screw or push-in terminals for sensor cables and supply cables. The terminals for the fieldbus connection (1+ and 2-) are independent of polarity. A shielded cable must be used for the connection.

Terminal design	Cable design	Cable cross-section
Screw terminals	Rigid or flexible	$\leq 2.5 \text{ mm}^2$ (14 AWG)
Push-in terminals (cable design, stripping length = min. 10 mm (0.39 in))	Rigid or flexible ¹⁾	0.2 to 1.5 mm ² (24 to 16 AWG)
	Flexible with wire end ferrules with/without plastic ferrule	0.25 to 1.5 mm ² (24 to 16 AWG)

1) In the case of push-in terminals and flexible cables with a cross-section $\leq 0.3 \text{ mm}^2$ (22 AWG), wire end ferrules must be used.

 For more information on shielding, connector PIN assignment, etc., see "Ethernet-APL Engineering Guideline" at <https://www.ethernet-apl.org>

6.2.2 Supply voltage

Connecting to an APL field switch

The device must be used in accordance with the APL port classification:

Hazardous areas: SLAA or SLAC (details in Ex safety instructions)

Non-hazardous areas: SLAX connection to an APL field switch with maximum voltage of 15 VDC and minimal output power of 0.54 W. This corresponds to an APL field switch with APL port classification SPCC or SPAA, for example.

Ethernet-APL power class A (9.6 to 15 V_{DC}, 540 mW)

Maximum power consumption: 0.7 W

Connecting to an SPE switch

In non-hazardous areas, the device can be used with a suitable SPE field switch: The device can be connected to an SPE switch with a maximum voltage of 30 VDC and a minimum output power of 1.85 W. The SPE switch must support the 10BASE-T1L standard and the PoDL power classes 10, 11 or 12 and recognize SPE field devices without an integrated PoDL module.

 The field switch must be tested to ensure that it meets safety requirements (e.g. PELV, SELV, Class 2).

6.3 Connecting the sensor cables

Terminal assignment of sensor connections

NOTICE

When connecting 2 sensors ensure that there is no galvanic connection between the sensors (e.g. caused by sensor elements that are not isolated from the thermowell). The resulting equalizing currents distort the measurements considerably.

- ▶ The sensors must remain galvanically isolated from one another by connecting each sensor separately to a transmitter. The transmitter provides sufficient galvanic isolation (> 2 kV AC) between the input and output.

The following connection combinations are possible when both sensor inputs are assigned:
→  15

		Sensor input 1				
		RTD or resistance transmitter, 2-wire	RTD or resistance transmitter, 3-wire	RTD or resistance transmitter, 4-wire	TC, voltage transmitter, internal CJ	TC, voltage transmitter, external CJ
Sensor input 2	RTD or resistance transmitter, 2-wire	✓	✓	-	✓	-
	RTD or resistance transmitter, 3-wire	✓	✓	-	✓	-
	RTD or resistance transmitter, 4-wire	-	-	-	-	-
	TC, voltage transmitter, internal CJ	✓	✓	✓	✓	-
	TC, voltage transmitter, external CJ	✓	✓	-	-	✓

Internal and external cold junctions (CJ) are selectable reference junction measurements for the connection of thermocouple sensors (TC).

- Internal CJ: the internal cold junction temperature is used.
- External CJ: an RTD resistance sensor Pt1000 must also be connected.

6.3.1 Connecting to push-in terminals

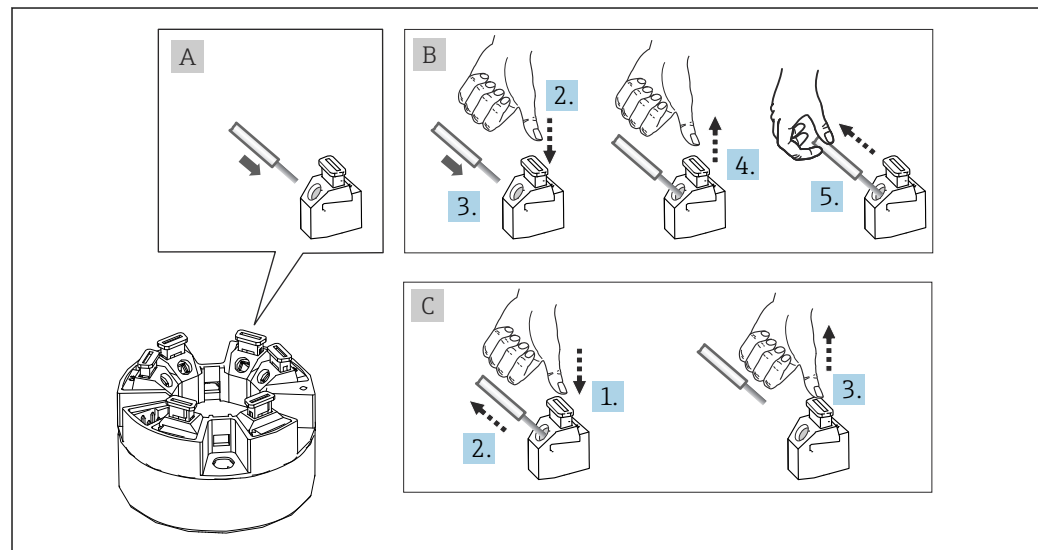

 7 Connecting to push-in terminals

Fig. A, solid wire:

1. Strip wire end. Min. stripping length 10 mm (0.39 in).
2. Insert the wire end into the terminal.
3. Pull the wire gently to ensure it is connected correctly. Repeat from step 1 if necessary.

Fig. B, fine-strand wire without ferrule:





1. Strip wire end. Min. stripping length 10 mm (0.39 in).
2. Press down on the lever opener.
3. Insert the wire end into the terminal.
4. Release lever opener.
5. Pull the wire gently to ensure it is connected correctly. Repeat from step 1 if necessary.

Fig. C, releasing the connection:

1. Press down on the lever opener.
2. Remove the wire from the terminal.
3. Release lever opener.

6.4 Ensuring the degree of protection

Compliance with the following points is mandatory following installation in the field or servicing in order to ensure that IP67 protection is maintained:

- The transmitter must be mounted in a terminal head with the appropriate degree of protection.
- The housing seals must be clean and undamaged when inserted into their grooves. The seals must be dried, cleaned or replaced if necessary.
- The connecting cables used must have the specified external diameter (e.g. M20x1.5, cable diameter 8 to 12 mm).
- Firmly tighten the cable gland. →  8,  19
- The cables must loop down before they enter the cable glands ("water trap"). This means that any moisture that may form cannot enter the gland. Install the device in such a way that the cable glands are not facing upwards. →  8,  19
- Replace unused cable glands with dummy plugs.
- Do not remove the grommet from the cable gland.

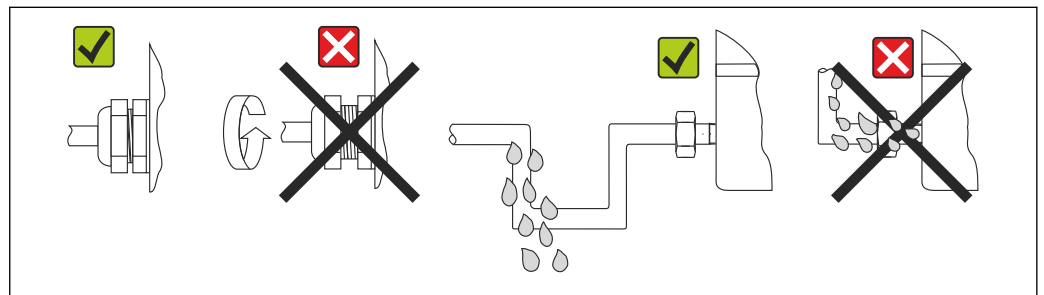

A0024523

 8 Connection tips to retain IP67 protection

6.5 Post-connection check

Device condition and specifications	Notes
Is the device or cable undamaged (visual check)?	--
Electrical connection	Notes
Does the port classification match the information on the nameplate?	Compare the port classification with the information on the nameplate
Do the cables used meet the required specifications?	Fieldbus cable, Sensor cable, →  17
Are the mounted cables relieved of tension?	--

Device condition and specifications	Notes
Are the power supply and signal cables connected correctly?	→ 📄 15
Are all the screw terminals firmly tightened and have the push-in terminal connections been checked?	→ 📄 18
Are all the cable entries mounted, tightened and leak-tight? Cable run with "water trap"?	--
Are all housing covers installed and firmly tightened?	--
Electrical connection of the fieldbus system	Notes
Are all connecting components (switch, device connector, etc.) correctly connected to each other?	--
Does the max. length of the fieldbus cable comply with the fieldbus specifications?	For more information, see www.ethernet-apl.org "Ethernet-APL Engineering Guideline"
Does the max. length of the spurs match the fieldbus specifications?	
Is the fieldbus cable fully shielded and correctly grounded?	

7 Operation options

7.1 Overview of operation options

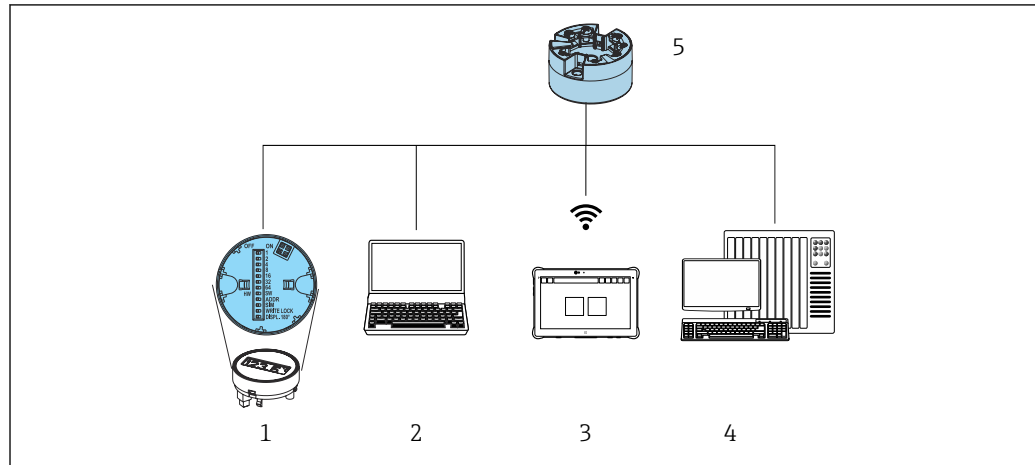

- 1 Local operation via DIP switch on display module
- 2 Computer with web browser or with operating tool (e.g. FieldCare, DeviceCare, SIMATIC PDM)
- 3 Field Xpert SMT70
- 4 Control system (e.g. PLC)
- 5 Temperature transmitter

There are different ways in which the operator can configure and commission the device:

1. Miniature switches (DIP switches) for various hardware settings, optional

→ 📄 22

You can make the following hardware settings via DIP switches positioned on the rear of the optional display:

- switch the hardware write protection on/off
- rotate the display 180 °
- activate the service IP address **192.168.1.212**

2. Configuration programs

Profile parameters and device-specific parameters are configured exclusively via the fieldbus interface. Special configuration and operating programs are available from various manufacturers for this purpose.

7.1.1 Measured value display and operating elements

i For the head transmitter, display and operating elements are available locally only if the head transmitter was ordered with a display unit! The display can also be ordered subsequently, see the "Accessories" section

Display elements

Head transmitter

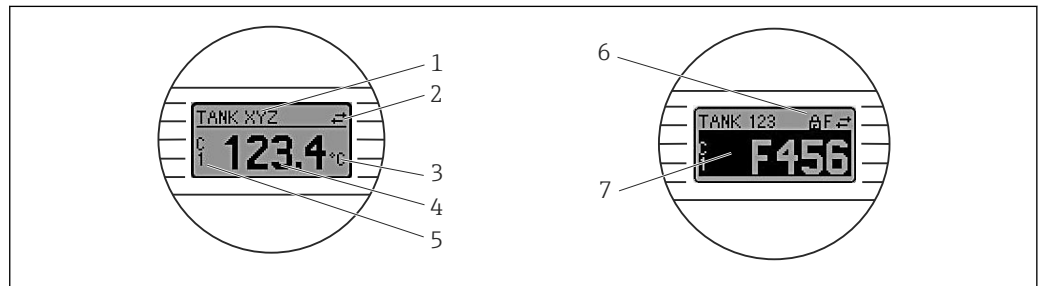

A0008549

9 Optional LC display for head transmitter

Item No.	Function	Description
1	Displays the device tag.	Device tag, 32 characters.
2	'Communication' symbol	The communication symbol appears when read and write-accessing via the fieldbus protocol.
3	Unit display	Unit display for the measured value displayed.
4	Measured value display	Displays the current measured value.
5	Value/channel display	C1 = sensor 1 measured value C2 = sensor 2 measured value DT = device temperature Cx = channel for diagnostic messages
6	'Configuration locked' symbol	The 'configuration locked' symbol appears when configuration is locked via the hardware.
7	Status signals	
	Symbols	Meaning
	F	"Failure" error message An operating error has occurred. The measured value is no longer valid. The display alternates between the error message and "- - -" (no valid measured value present), see "Diagnostics and troubleshooting" section.
	C	"Function check" The device is in the service mode (e.g. during a simulation).
	S	"Out of specification" The device is being operated outside its technical specifications (e.g. during startup or cleaning processes).
	M	"Maintenance required" Maintenance is required. The measured value is still valid. The display alternates between the measured value and the status message.

Local operation

NOTICE

- ▶  ESD - Electrostatic discharge. Protect the terminals from electrostatic discharge. Failure to observe this may result in the destruction or malfunction of parts of the electronics.

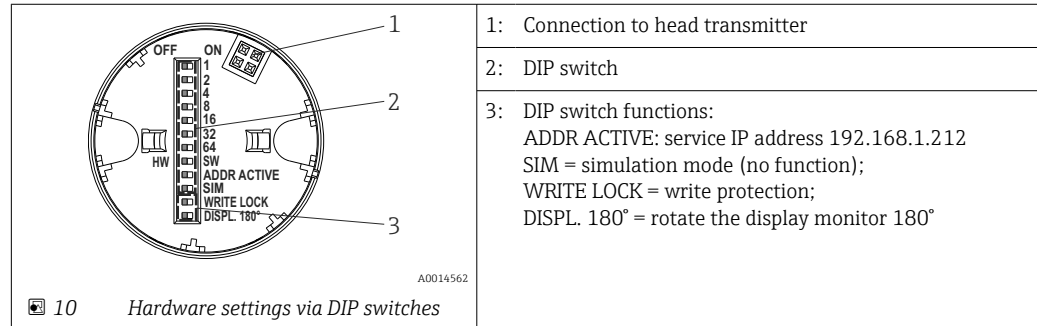

Procedure for setting the DIP switch:

1. Open the cover of the terminal head or field housing.
2. Remove the attached display from the head transmitter.
3. Configure the DIP switch on the rear of the display accordingly. In general: switch to ON = function enabled, switch to OFF = function disabled.
4. Fit the display onto the head transmitter in the correct position.
5. Secure the cover back onto the terminal head or field housing.

Switching write protection on/off

Write protection is switched on and off via a DIP switch on the rear of the optional attachable display.

 When write protection is active, parameters cannot be modified. A lock symbol on the display indicates that write protection is on. Write protection remains active even when the display is removed. To disable write protection, the display must be attached to the transmitter with the DIP switch deactivated (WRITE LOCK = OFF). The transmitter adopts the setting during operation and does not need to be restarted.

Turning the display

The display can be rotated 180° via a DIP switch.

Setting the service IP address

The service IP address can be set via a DIP switch.

Procedure for activating the service IP address:

1. Set ADDR ACTIVE DIP switch to **ON**.
2. Connect the display.
3. Wait until the display has fully started.
4. Disconnect the device from the power supply and then reconnect it (power cycle).
5. After restarting, the device communicates only with the service IP address.

Procedure for deactivating the service IP address:

1. Set ADDR ACTIVE DIP switch to **OFF**.
2. Connect the display.
3. Wait until the display has fully started.

4. Disconnect the device from the power supply and then reconnect it (power cycle).
5. After restarting, the device no longer communicates with the service IP address but with the last IP address set.

7.2 Structure and function of the operating menu

7.2.1 Structure of the operating menu

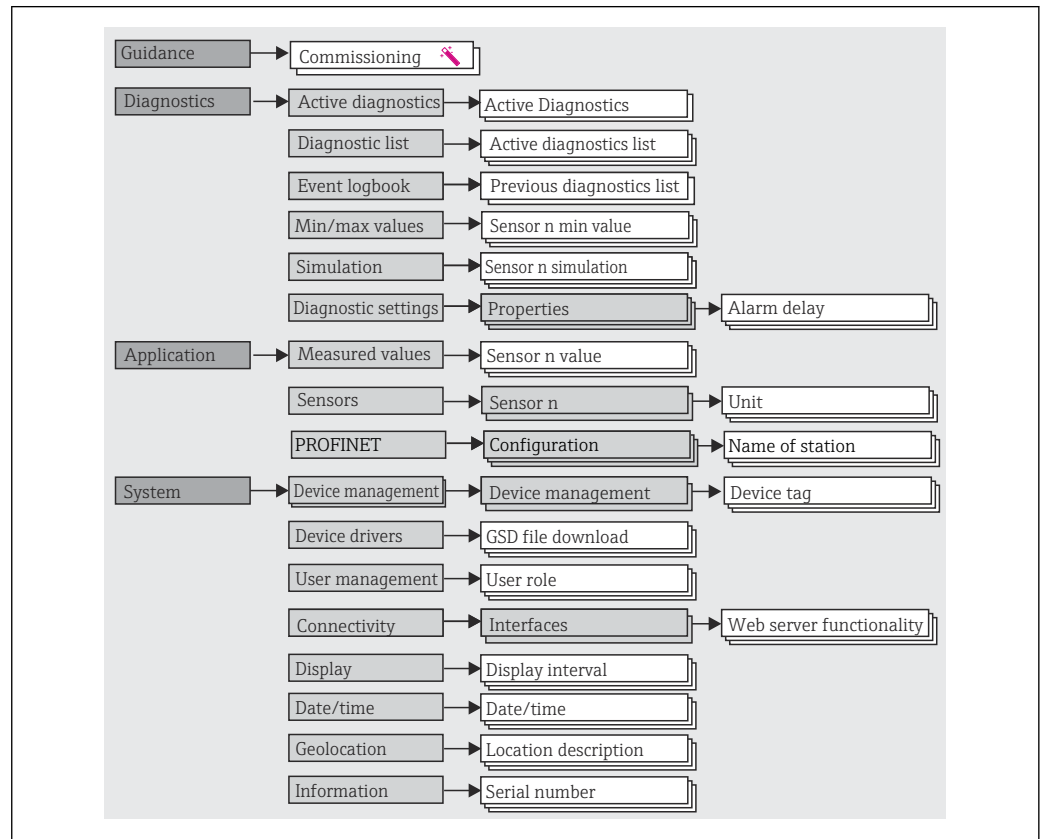

A0050431

User roles

The role-based access concept consists of two hierarchical levels for the user and presents the various user roles with defined read/write authorizations derived from the NAMUR shell model.

- **Operator**

The plant operator can only change settings that do not affect the application - and particularly the measuring path - and simple, application-specific functions that are used during operation. The operator is able to read all the parameters, however.

- **Maintenance**

The **Maintenance** user role refers to configuration situations: commissioning and process adaptations as well as troubleshooting. It allows the user to configure and modify all available parameters. In contrast to the **Operator** user role, in the **Maintenance** role the user has read and write access to all the parameters.

- **Changing the user role**

A user role - and therefore existing read and write authorization - is changed by selecting the desired user role (already pre-selected depending on the operating tool) and entering the correct password when subsequently prompted. When a user logs out, system access always returns to the lowest level in the hierarchy. A user is logged out either by actively selecting the logout function when operating the device or is logged out automatically if the device is not operated for a period of over 600 seconds. Irrespective of this, actions that are already in progress (e.g. active upload/download, data logging, etc.) continue to be executed in the background.

- **As-delivered state**

The **Operator** user role is not enabled when the device is delivered from the factory, i.e. the **Maintenance** role is the lowest level in the hierarchy ex-works. This state makes it possible to commission the device and make other process adaptations without having to enter a password (webserver: 0000). Afterwards, a password can be assigned for the **Maintenance** user role to protect this configuration. The **Operator** user role is not visible when the device is delivered from the factory.

- **Password**

The **Maintenance** user role can assign a password in order to restrict access to device functions. This activates the **Operator** user role, which is now the lowest hierarchy level where the user is not asked to enter a password. The password can only be changed or disabled in the **Maintenance** user role. A password can be defined at different points in the operation of the device:

In the **Guidance** → **Commissioning** menu: as a component in the guided device operation

In the **System** → **User management** menu

Submenus

Menu	Typical tasks	Content/meaning
"Diagnostics"	Troubleshooting: <ul style="list-style-type: none"> ▪ Diagnosing and eliminating process errors. ▪ Error diagnostics in difficult cases. ▪ Interpretation of device error messages and correcting associated errors. ▪ Measured value and diagnostic simulation. 	Contains all parameters for detecting and analyzing errors: <ul style="list-style-type: none"> ▪ Diagnostic list Contains the diagnostic events currently pending ▪ Event logbook Contains a list of device events ▪ "Simulation" submenu Used to simulate measured values or diagnostic messages ▪ "Properties" submenu Contains all the parameters for configuring error events ▪ "Min/max values" submenu Contains the minimum/maximum indicator and the reset option
"Application"	Commissioning: <ul style="list-style-type: none"> ▪ Configuration of the measurement. ▪ Configuration of inputs and outputs Tasks during operation: Reading measured values.	Contains all of the parameters for commissioning: <ul style="list-style-type: none"> ▪ "Measured values" submenu Contains all the current measured values ▪ "Sensor" submenu Contains all the parameters for configuring the measurement ▪ "PROFINET" submenu Contains all of the parameters for configuring the communication-specific output signals
"System"	Tasks that require detailed knowledge of the system administration of the device: <ul style="list-style-type: none"> ▪ Optimum adaptation of the measurement for system integration. ▪ Detailed configuration of the communication interface. ▪ User and access administration, password control. ▪ Information for device identification and display configuration. 	Contains all higher-level device parameters that are assigned to system, device and user management. <ul style="list-style-type: none"> ▪ "Device management" submenu Contains parameters for general device management ▪ "User management" submenu Parameters for access authorization, password assignment, etc. ▪ "Connectivity" submenu (option) Contains the parameters for configuring the communication interface ▪ "Display" submenu Configuration of display ▪ "Date/time" submenus Configuration and display of date/time ▪ "Information" submenu Contains all the parameters for the unique identification of the device



For a detailed overview of all operating parameters, see the associated description of device parameters (GP)

7.3 Access to operating menu via web browser

The device can be operated and configured via a web browser with the integrated web server. A web server is enabled when the device is delivered, but can be disabled via an appropriate parameter.

7.3.1 Function scope

The structure of the operating menu is the same as for other operating tools. In addition to the measured values, device status information is also displayed and allows users to monitor the status of the device. Furthermore the device data can be managed and the network parameters can be configured.

7.3.2 Prerequisites



Access to the network is required for the Ethernet-APL connection.

Computer software

Software	
Recommended operating systems	<ul style="list-style-type: none"> ▪ Microsoft Windows 7 or higher. ▪ Mobile operating systems: <ul style="list-style-type: none"> ▪ iOS ▪ Android <p> Microsoft Windows XP is supported.</p>
Web browsers supported	<ul style="list-style-type: none"> ▪ Microsoft Edge ▪ Mozilla Firefox ▪ Google Chrome ▪ Safari

Computer settings

Settings	Interface
User rights	Corresponding user rights (e.g. administrator rights) for TCP/IP and proxy server settings are required (for changing the IP address, subnet mask etc.).
Proxy server settings of the web browser	The web browser setting <i>Use a proxy server for your LAN</i> must be deselected .
JavaScript	<p>JavaScript must be enabled.</p> <p> When installing a new firmware version: To enable correct data display, clear the temporary memory (cache) of the web browser under Internet options.</p>

7.3.3 Connecting to the web server

Via PROFINET with Ethernet-APL network

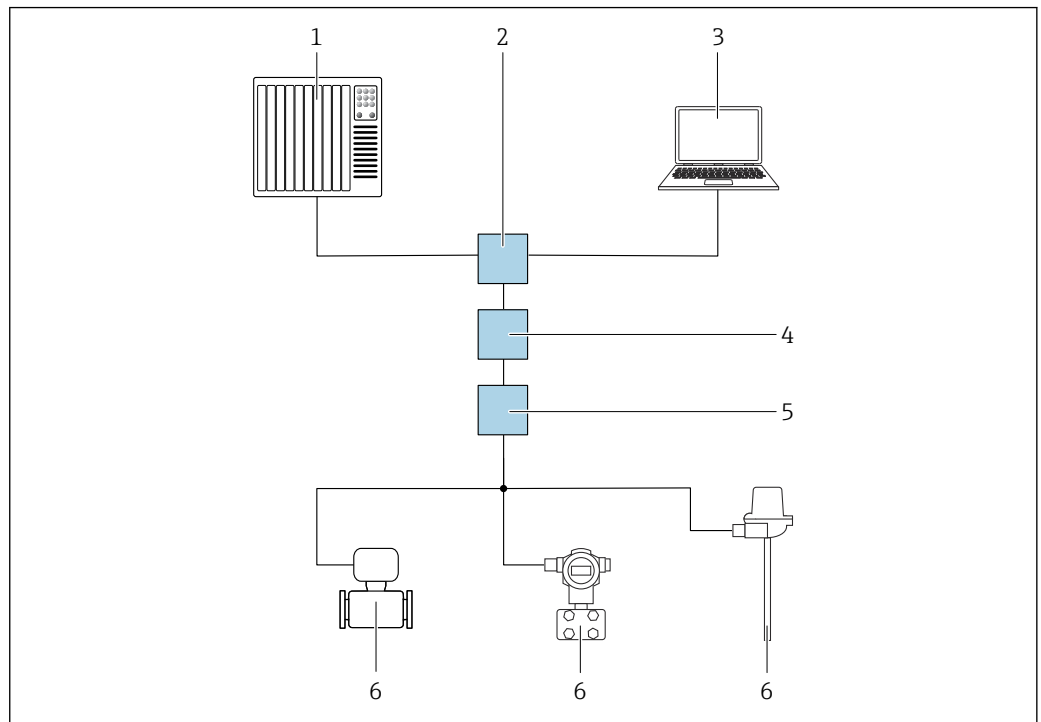

11 Options for remote operation via PROFINET with Ethernet-APL network: star topology

- 1 Automation system, e.g. Simatic S7 (Siemens)
- 2 Ethernet switch
- 3 Computer with web browser (e.g. Microsoft Edge) for accessing the integrated device web server or computer with operating tool (e.g. FieldCare, DeviceCare, SIMATIC PDM) with iDTM Profinet Communication
- 4 APL power switch (optional)
- 5 APL field switch
- 6 APL field device

Call up the website via the computer in the network. The IP address of the device must be known.

The IP address can be assigned to the device in a variety of ways:

- Dynamic Configuration Protocol (DCP), factory setting
The automation system (e.g. Siemens S7) automatically assigns the IP address to the device
- Software addressing
The IP address is entered via the IP address parameter
- DIP switch for service
The device then has the fixed IP address 192.168.1.212
The IP address can now be used to establish the connection to the network

The default setting is that the device uses the Dynamic Configuration Protocol (DCP). The automation system (e.g. Siemens S7) automatically assigns the IP of the device.

Starting the web browser and logging in

1. Start the web browser on the computer.
2. Enter the IP address of the web server in the address line of the web browser, e.g. 192.168.1.212
↳ The login page appears.

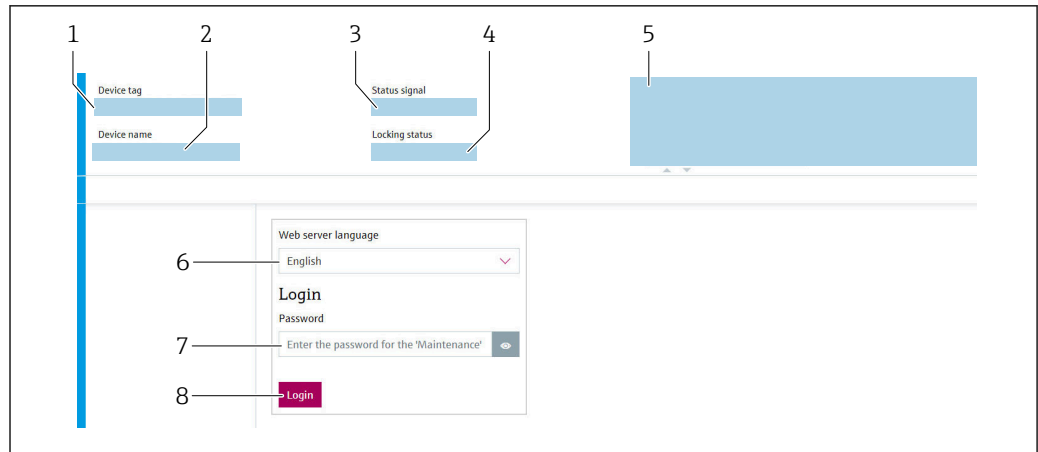

A0050398

- 1 Device tag
- 2 Device name
- 3 Status signal
- 4 Locking status
- 5 Current measured values
- 6 Operating language
- 7 Password
- 8 Login

1. Select the preferred operating language for the web server.
2. Enter the password.
3. Select Login to confirm your entry.

7.3.4 User interface of web server

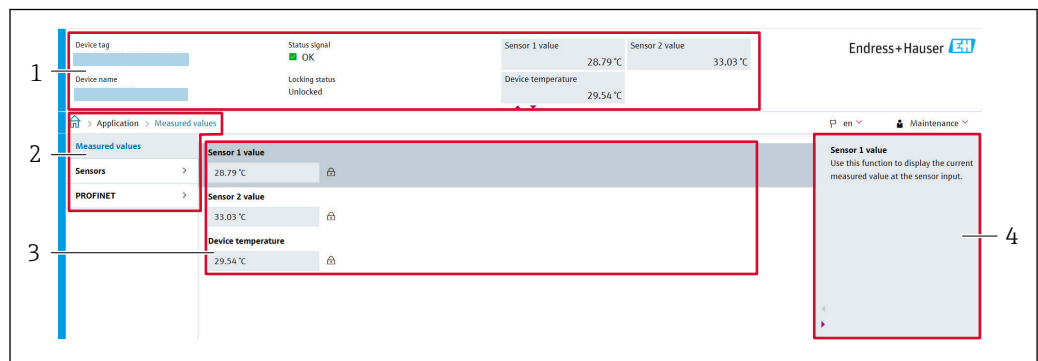

A0050404

- 1 Header
- 2 Navigation area
- 3 Work area
- 4 Help section

Header

The following information appears in the header:

- Device name
- Device tag
- Device status with status signal
- Current measured values

Navigation area

If a function is selected in the function bar, the submenus of the function open in the navigation area. The user can now navigate within the menu structure.

Work area

Depending on the selected function and the related submenus, various actions can be performed in this area:

- Configuring parameters
- Reading measured values
- Downloading the GSD file
- Downloading the configuration report
- Updating the device firmware

7.3.5 Disabling the web server

The web server of the measuring device can be switched on and off as required using the **Web server functionality** parameter.

Enabling the web server

If the web server is disabled, it can only be re-enabled with the **Web server functionality** parameter via the following operating options:

- via the "FieldCare" operating tool
- via the "DeviceCare" operating tool

7.3.6 Logging out

1. Select the **Logout** entry in the user role.
 - ↳ The home page with the Login box appears.
2. Close the web browser.
3. If no longer needed:
 - Reset the modified properties of the Internet protocol (TCP/IP).

 Once communication with the web server is established via the standard IP address 192.168.1.212 using the display, the DIP switch on the back of the display must be reset (from **ON** → **OFF**). Afterwards, the IP address of the device is active again for network communication.

7.4 Access to the operating menu via operating tools

Operating tools

DeviceCare (Endress+Hauser) FieldCare (Endress+Hauser) Field Xpert SMT70 (Endress +Hauser)	SIMATIC PDM (Siemens) Field Device Manager FDM (Honeywell) Fieldbus Information Manager FIM (ABB)
---	---

7.4.1 Establishing a connection via FieldCare and DeviceCare

Via PROFINET protocol

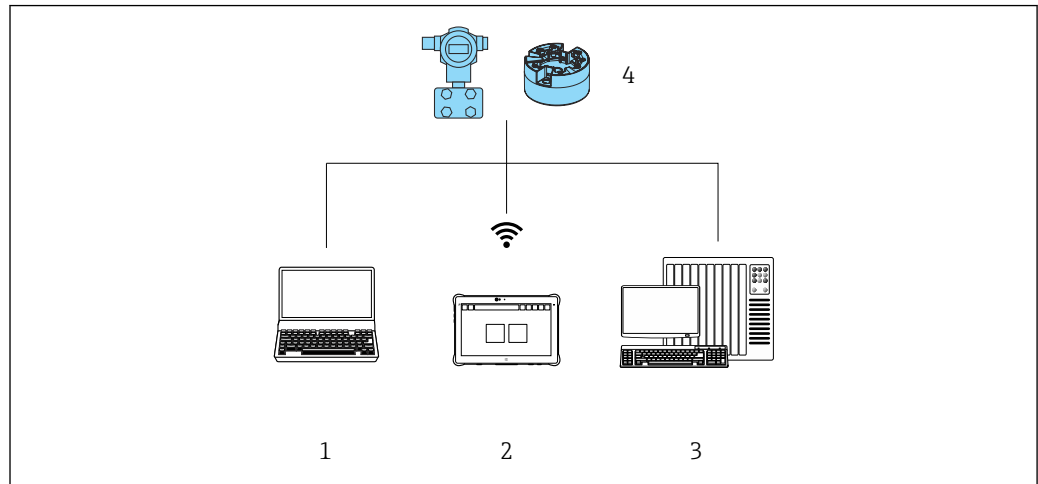

A0048419

12 Options for remote operation via PROFINET protocol

- 1 Computer with web browser or operating tool (e.g. FieldCare, DeviceCare, AMS Device Manager, SIMATIC PDM)
- 2 Field Xpert SMT70
- 3 Automation system (e.g. PLC)
- 4 Measuring device (e.g. temperature transmitter)

FieldCare/DeviceCare via service interface (CDI)

i Communication via CDI is possible only if the device is connected to a suitable power supply.

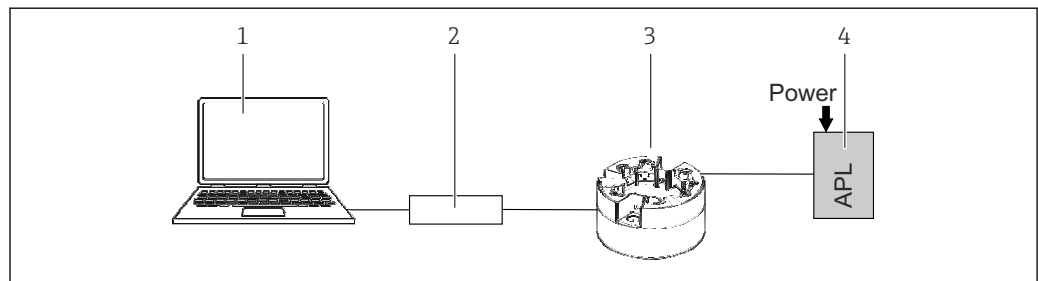

A0048376

- 1 Computer with operating tool (e.g. FieldCare, DeviceCare)
- 2 Commubox FXA291
- 3 Temperature transmitter
- 4 Ethernet-APL switch or SPE switch

8 System integration

8.1 Overview of device description files

Version data for the device

Firmware version	01.01.zz	<ul style="list-style-type: none"> ▪ On the title page of the manual ▪ On the nameplate ▪ Firmware version parameter System → Information → Firmware version
Device ID	0xA3FF	<ul style="list-style-type: none"> ▪ On the nameplate ▪ Device ID parameter Application → PROFINET → Information → Device ID
Device type	TMT86	Device name parameter System → Information → Device name
Device revision	1	On the nameplate
PROFINET version	PROFINET version: 2.4MU2 Profile version: 4.02	PA Profile Version parameter Application → PROFINET → Information → PA Profile Version

The suitable device driver software (GSD/FDI Package) for the individual operating tools can be obtained from different sources:

- www.endress.com → Downloads → Search field: Software → Software type: Device driver
- www.endress.com → Products: individual product page, e.g. TMT8x → Documents / Manuals / Software: GSD or FDI Package.
- The GSD file can also be downloaded from the device web server: **System → Device drivers**

Endress+Hauser supports all common operating tools from a variety of manufacturers (e.g. ABB, Siemens, Honeywell and many more). Endress+Hauser's FieldCare and DeviceCare operating tools are also available for download (www.endress.com → Downloads → Search field: Software → Application software) or on the optical data storage medium (DVD) which you can obtain from your local Endress+Hauser sales organization.

8.2 Overview of system files

8.2.1 Device master file (GSD)

In order to integrate field devices into a bus system, the PROFINET system needs a description of the device parameters, such as output data, input data, data format and data volume.

These data are available in the device master file (GSD) which is provided to the automation system when the communication system is commissioned. In addition device bit maps, which appear as icons in the network structure, can also be integrated.

The device master file (GSD) is in XML format, and the file is created in the GSDML description markup language.

8.2.2 File name of the device master file (GSD)

Example of the name of a device master file:

GSDML-Vx.x.x-EH-iTEMP_TMT86-yyyymmdd.xml

GSDML	Description language
Vx.x.x	Version of the PROFINET specification
EH	Manufacturer
iTEMP	Instrument family
TMT86	Transmitter
yyyymmdd	Date of issue (yyyy: year, mm: month, dd: day)
.xml	File name extension (XML file)

8.3 Cyclic data transmission

8.3.1 Description of the modules

 The following graphic shows which modules are available to the device for cyclic data exchange. Cyclic data exchange is performed with an automation system.

The data structure is described from the perspective of the automation system:

- Input data: are sent from the device to the automation system
- Output data: are sent from the automation system to the device

Analog Input module

Transmission of input variables from the device to the automation system:

Analog Input modules cyclically transmit the selected input variables, including the status, from the measuring device to the automation system. The input variable is depicted in the first four bytes in the form of a floating point number as per the IEEE 754 standard. The fifth byte contains status information pertaining to the input variable.

Device Module	Slot	Direction Data flow	Control system
Sensor 1 or sensor backup	1	→	PROFINET
Sensor 2	20	→	
Electronics temperature	21	→	
Average (S1+S2)/2	22	→	
Difference temperature sensor 1 - sensor 2	23	→	

8.3.2 Status coding

Status	Coding (hex)	Meaning
BAD - Maintenance alarm	0x24	No measured value available, as a device error has occurred.
BAD - Process related	0x28	No measured value available, as the process conditions are not within the device's technical specification limits.
BAD - Function check	0x3C	A function check is active (e.g. cleaning or calibration)
UNCERTAIN - Initial value	0x4F	A predefined value is output until a correct measured value is available again or corrective measures have been performed that change this status.
UNCERTAIN - Maintenance demanded	0x68	Wear and tear has been detected. Maintenance is needed shortly to ensure the device remains operational. The measured value might be invalid. The use of the measured value depends on the application.

Status	Coding (hex)	Meaning
UNCERTAIN - Process related	0x78	The process conditions are not within the device's technical specification limits. This could have a negative impact on the quality and accuracy of the measured value. The use of the measured value depends on the application.
GOOD - OK	0x80	No error has been diagnosed.
GOOD - Maintenance demanded	0xA8	The measured value is valid. It is highly advisable to service the device in the near future.
GOOD - Function check	0xBC	The measured value is valid. The device performs an internal function check. The function check does not have any noticeable effect on the process.

8.3.3 Factory setting

The slots are already assigned in the automation system for initial commissioning.

Assignment of slots:

- 1: Sensor 1
- 20: -
- 21: Electronics temperature
- 22: -
- 23: -

8.3.4 Startup configuration

Startup configuration (NSU)	<p>If startup configuration is enabled, the configuration of the most important device parameters is taken from the automation system and used.</p> <ul style="list-style-type: none"> ▪ Management: <ul style="list-style-type: none"> ▪ Software revision ▪ Write protection ▪ Web server functionality ▪ System units: <ul style="list-style-type: none"> Temperature ▪ Process: <ul style="list-style-type: none"> ▪ Damping ▪ Temperature ▪ Calculation of scaled variable: <ul style="list-style-type: none"> Type of linearization and linearization values ▪ Alarm delay ▪ Diagnostic settings ▪ Diagnostic behavior for diverse diagnostic information ▪ Interfaces: <ul style="list-style-type: none"> ▪ Web server functionality ▪ Service (UART-CDI) ▪ Sensor 1: <ul style="list-style-type: none"> ▪ Unit ▪ Sensor type ▪ Connection type ▪ 2-wire compensation ▪ Cold junction ▪ Sensor offset ▪ Call./v. Dusen coeff. R0 ▪ Call./v. Dusen coeff. A ▪ Call./v. Dusen coeff. B ▪ Call./v. Dusen coeff. C ▪ Polynomial coeff. R0: <ul style="list-style-type: none"> ▪ Polynomial coeff. A ▪ Polynomial coeff. B ▪ Sensor 2: <ul style="list-style-type: none"> ▪ Unit ▪ Sensor type ▪ Connection type ▪ 2-wire compensation ▪ Cold junction ▪ Sensor offset ▪ Call./v. Dusen coeff. R0 ▪ Call./v. Dusen coeff. A ▪ Call./v. Dusen coeff. B ▪ Call./v. Dusen coeff. C ▪ Polynomial coeff. R0: <ul style="list-style-type: none"> ▪ Polynomial coeff. A ▪ Polynomial coeff. B ▪ Sensor backup
-----------------------------	---

8.3.5 System redundancy S2

A redundant layout with two automation systems is necessary for processes that are in continuous operation. If one system fails the second system guarantees continued, uninterrupted operation. The device supports S2 system redundancy and can communicate simultaneously with both automation systems.

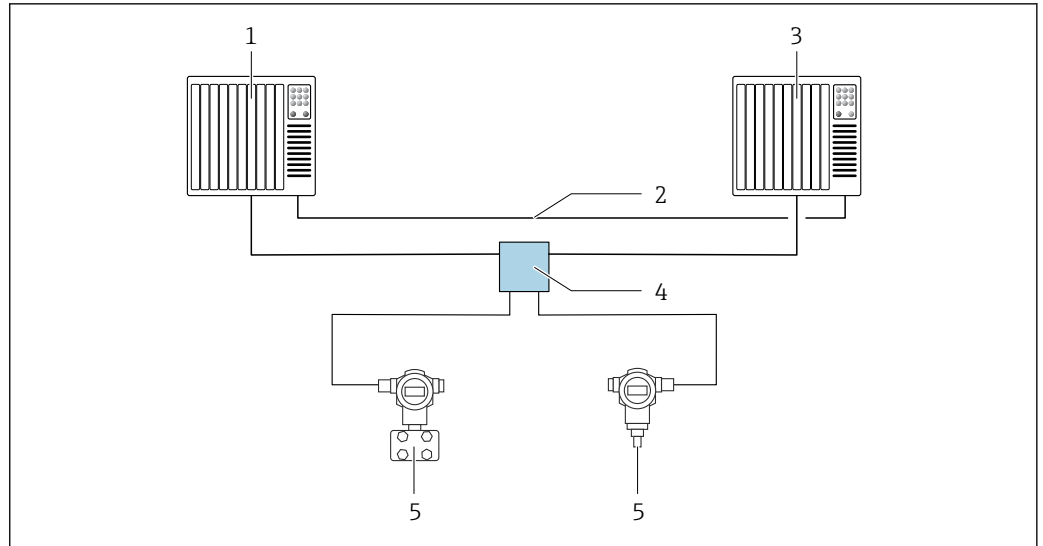

A0046154

13 Example of the layout of a redundant system (S2): star topology

- 1 Automation system 1
- 2 Synchronization of automation systems
- 3 Automation system 2
- 4 Ethernet-APL field switch
- 5 Device (e.g. temperature transmitter)

i All the devices in the network must support S2 system redundancy.

9 Commissioning

9.1 Installation check

Before commissioning the measuring point make sure that all final checks have been carried out:

- "Post-installation check" checklist
- "Post-connection check" checklist

9.2 Switching on the device

Switch on the supply voltage after completing the final checks. The transmitter performs a number of internal test functions after power-up. As this procedure progresses, a sequence of device information appears on the display.

Step	User interface
1	Display name and firmware version (FW)
2	Device name, firmware (FW) and hardware (HW) version and device revision of head transmitter
3	Name of station
4	MAC address and IP address
5	Sensor configuration
6a	Current measured value or
6b	Current status message  If the switch-on procedure is not successful, the relevant diagnostic event, depending on the cause, is displayed. A detailed list of diagnostic events and the corresponding troubleshooting instructions can be found in the "Diagnostics and troubleshooting" section .

Normal measuring mode commences as soon as the switch-on procedure is completed. Measured values and status values appear on the display.

9.3 Configuring the device address via software

The IP address is set via the **IP address** parameter (System → Connectivity → Ethernet → Properties).

9.3.1 Setting the service IP address

If the IP address of the device is assigned via a software address and this IP address is unknown, the network connection can be established via the web server by enabling the service IP address. The service IP address becomes active (ADDR ACTIVE = 1) as soon as the display is connected to the device and the device is restarted. When the configuration of the measuring device is complete, the "ADDR ACTIVE" DIP switch must be disabled again (0) and the device restarted. After restarting, the measuring device uses the IP address originally configured, and the device is reconnected to the network.

9.4 Device configuration

The transmitter is configured and measured values obtained via the Ethernet or CDI (= Common Data Interface) interface.

 For detailed information on configuring specific parameters, see the associated Description of Device Parameters (GP)

Wizards

The starting point for device wizards is in the **Guidance** menu. Wizards are used not only to query individual parameters, but also to guide the operator through the configuration and verification of entire parameter combinations by means of a clearly structured sequence, including prompts. In the case of wizards requiring specific access authorization, the **Start** button may be disabled (lock symbol).

9.4.1 DeviceCare

Function scope

DeviceCare is a free configuration tool for Endress+Hauser devices. It supports devices with the following protocols, provided a suitable driver (device DTM) is installed: HART, PROFIBUS, FOUNDATION Fieldbus, PROFINET, Ethernet/IP, Modbus, CDI, ISS, IPC and PCP. The target group comprises customers without a digital network in plants and service centers as well as Endress+Hauser service technicians. The devices can be connected directly via a modem (point-to-point) or a bus system. DeviceCare is fast, easy and intuitive to use. It can run on a PC, laptop or tablet with a Windows operating system.

Source for device description files

See information in the "System integration" section.

User interface

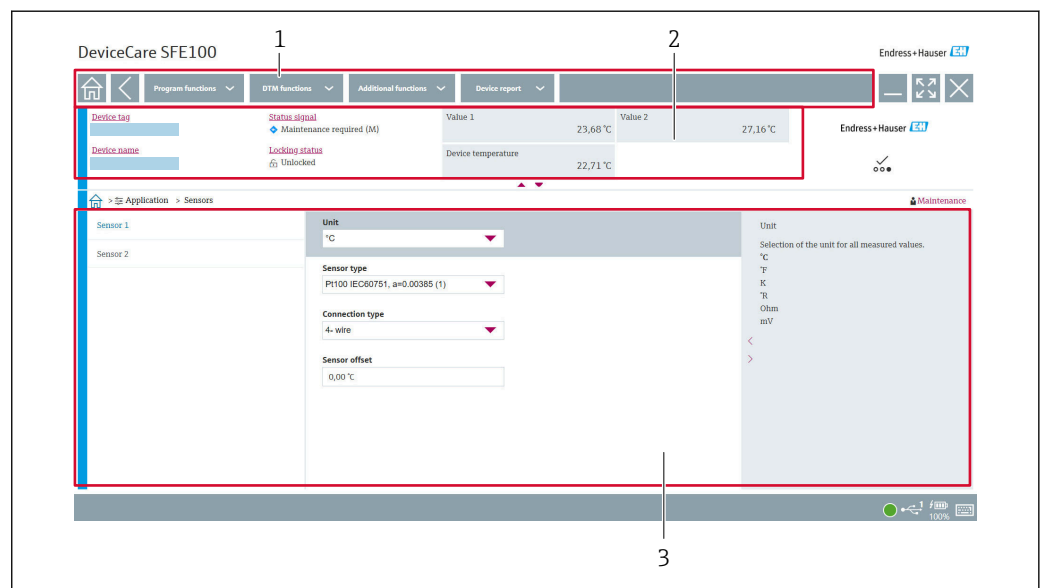

14 DeviceCare user interface with device information

- 1 Navigation area
- 2 Displays device name, current status, current measured values
- 3 Device parameter configuration section

9.4.2 FieldCare

Function scope

FDT/DTM-based plant asset management tool from Endress+Hauser. It can configure all smart field units in a system and helps you manage them. By using the status information, it is also a simple but effective way of checking their status and condition. Access is via a CDI (= Common Data Interface) interface. It supports devices with the following protocols,

provided a suitable driver (device DTM) is installed: HART, PROFIBUS, FOUNDATION Fieldbus, PROFINET, Ethernet/IP, Modbus, CDI, ISS, IPC and PCP.

Typical functions:

- Parameterization of transmitters
- Loading and saving of device data (upload/download)
- Documentation of the measuring point
- Visualization of the measured value memory (line recorder) and event logbook



For details, see Operating Instructions BA00065S, KA01303S and SD01928S

Source for device description files

See "System integration" section.

Connecting via CDI interface

1. Make sure that the DTM library is updated for all the connected devices.
2. Start FieldCare and create a project.
3. Go to **View** -> **Network**: right-click **Host PC** Add device...
 - ↳ The **Add new device** window opens.
4. Select the **CDI Communication FXA291** option from the list and press **OK** to confirm.
5. Right-click **CDI Communication FXA291** and select the **Add device...** option in the context menu that opens.
6. Select the desired device from the list and press **OK** to confirm.
 - ↳ The device now appears in the network list.
7. Right-click the device and select the **Connect** option in the context menu.
 - ↳ The CommDTM is displayed in green.
8. Establish the online connection to the device.



If transferring the device parameters following offline configuration, the password for the **Maintenance** user role - if assigned - must first be entered in the "**User management**" menu.

User interface

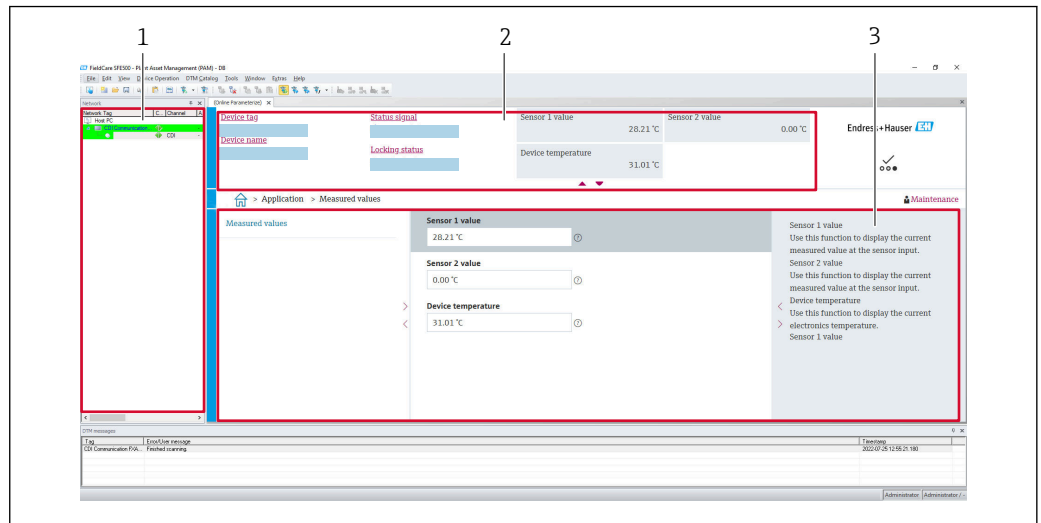

A0050411

15 FieldCare user interface with device information

- 1 Network view
- 2 Displays device name, current status, current measured values
- 3 Menu navigation, device parameterization, help section

9.4.3 Commissioning wizard

Commissioning is the first step towards using the device for the designated application. The commissioning wizard includes a welcome page (with **Start** operating element) and a table of contents as a brief description. The wizard consists of several sections in which the user is guided step-by-step through the commissioning of the device.

When the wizard is run, the first section, **Device management**, contains the following parameters and serves mainly to provide information about the device:

- Device tag
- Device name
- Serial number
- Extended order code (n) 1

All of the relevant settings concerning the sensor are performed in the next two **Sensor** sections. The number of parameters displayed depends on the corresponding settings.

The following parameters can be configured:

- Sensor type
- Connection type
- 2-wire compensation
- Cold junction
- RJ preset value

A password for the **Maintenance** user role can be assigned in the next section. This is strongly recommended to protect the device against unauthorized access. The following steps describe how to configure a password for the "**Maintenance**" user role for the first time.

Access authorization: set up the password for **Maintenance**

1. The two entry fields **New password** and **Confirm new password** appear.
2. **New password**: Enter a user-defined password that meets the password requirements described in the online help.
3. Enter the password again in the **Confirm new password** entry field.

Once the password has been entered successfully, parameter changes, particularly those that are needed for commissioning, process adaptation/optimization and troubleshooting,

can only be implemented in the **Maintenance** user role and if the password is entered successfully.

9.4.4 Creating the configuration report

In the submenu **Guidance** → **Configuration report**, the user can start generating a detailed configuration report. The report contains all the parameter settings and can be used for the documentation of the measuring point. Once completed, the configuration report is saved on the terminal.

9.4.5 Specifying the device tag

The device tag is equivalent to the device name (name of station) in the PROFINET specification (data length: 255 bytes).

The device name can be adapted via the automation system. The device name currently used is displayed in the **Device tag** parameter.

Navigation in the menu **System** → **Device management** → **Device tag** (Max. 32 characters, such as letters and numbers, e.g. EH_TMT86_serial number of the device).

9.4.6 Settings for the communication interfaces

The **Connectivity** submenu shows the user all of the current parameter settings used to select and configure the communication interfaces:

In the menu **System** → **Connectivity** → **Interfaces**, the web server functionality and/or the service interface (CDI) can be disabled.

The menu **System** → **Connectivity** → **Ethernet** → **Properties** contains the interface properties, such as:

- MAC address
- IP address
- Subnet mask

It also contains the Port, APL, TCP and UDP information.

9.4.7 Date and time

The submenu **System** → **Date/time** offers the user two ways to set the device's internal real time clock (RTC).

Set system time: By activating the **Set system time** button, the system time of the connected computer is transferred to the device.

Time synchronization via NTP (Network Time Protocol): In the **Activate NTP** parameter, select "Yes" and confirm. A valid NTP server address must then be entered. Afterwards, the device synchronizes its RTC with the specified NTP server.

9.5 Simulation

The **Diagnostics** → **Simulation** submenu enables you to simulate, without real process values, various process variables in the process and the device alarm mode, and to verify downstream signal chains (switching valves or closed-control loops).

9.6 Protecting settings from unauthorized access

9.6.1 Hardware locking

The device can be protected against unauthorized access by hardware locking. In the locking and access concept, hardware locking always has top priority. The device is write-

protected if the lock symbol appears in the header of the measured value display. To disable write protection, switch the write protection switch on the back of the display to the "OFF" position (hardware write protection).

9.6.2 Software locking

By assigning a password for the **Maintenance** user role, it is possible to restrict access authorization and protect the device against unauthorized access (see commissioning wizard).

The parameters are also protected against modification by logging out of the **Maintenance** user role and switching to the **Operator** user role. No lock symbol appears, however. To disable the write protection, the user must log on with the **Maintenance** user role via the relevant operating tool (see user role concept).

10 Operation

10.1 Reading off the device locking status

Displaying active write protection: **Status locking** parameter

System → **Device management**

Locking using the software

Locking using the hardware

10.2 Reading off measured values

All the measured values can be read off using the **Measured values** submenu.

Navigation

Menu **Application** → **Measured values**

Sensor 1 value

Sensor 2 value

Device temperature

10.3 Adapting the measuring device to the process conditions



The following options are available to adapt the measuring device to the specific process conditions:

- Basic settings using the Commissioning wizard
- Advanced settings using the operating menu

11 Diagnostics and troubleshooting

11.1 General troubleshooting

Always start troubleshooting with the checklists below if faults occur after startup or during operation. The checklists take you directly (via various queries) to the cause of the problem and the appropriate remedial measures.

 Due to its design, the device cannot be repaired. However, it is possible to send the device in for examination. See the information in the "Return" section. →  50

General errors

Problem	Possible cause	Remedy
Device is not responding.	Supply voltage does not match the required power supply. →  17	Check the voltage at the transmitter directly using a voltmeter and correct.
	Connecting cables are not in contact with the terminals.	Ensure electrical contact between the cable and the terminal.
	Electronics unit is defective.	Replace the device.



Check display (optionally in conjunction with head transmitter)

Problem	Possible cause	Remedy
Display is blank	No supply voltage	<ul style="list-style-type: none"> ▪ Check the supply voltage at the head transmitter, terminals + and -. ▪ Ensure that the display module holders are correctly seated and that the display module is properly connected to the head transmitter, . ▪ If possible, test the display module with other suitable head transmitters, e.g. an Endress+Hauser head transmitter.
	The display module is defective.	Replace the module.
	The electronics of the head transmitter are defective.	Replace the head transmitter.



Local error messages on the display

→  45



Faulty connection to the fieldbus host system

No connection can be made between the fieldbus host system and the device. Check the following points:

Problem	Possible cause	Remedy
Fieldbus connection	Wiring not creating contact Wire break	Check the data cable
Fieldbus connector (optional)	Incorrect assignment at fieldbus connector Wire break on connector	Check the pin assignment/wiring

Faulty connection to the fieldbus host system No connection can be made between the fieldbus host system and the device. Check the following points:		
Problem	Possible cause	Remedy
Fieldbus voltage	Defective switch Voltage too low or too high	Check whether a minimum bus voltage of $9 V_{DC}$ is present at the +/- terminals. Permitted range: 9 to 15 V_{DC} (APL); 20 to 30 V_{DC} (SPE)
Network structure	Permitted length of fieldbus wiring not observed Wrong cable types	Check permitted line length Observe APL cable specification



Error messages in the configuration software
→ 45

Application errors without status messages for RTD sensor connection

Problem	Possible cause	Remedy
Measured value is incorrect/ inaccurate	Incorrect sensor orientation.	Install the sensor correctly.
	Heat conducted by sensor.	Observe the installed length of the sensor.
	Device programming is incorrect (number of wires).	Change the Connection type device function.
	Incorrect RTD configured.	Change the Sensor type device function.
	Sensor connection.	Check that the sensor is connected correctly.
	The cable resistance of the sensor (2-wire) was not compensated.	Compensate the cable resistance.
	Offset incorrectly set.	Check offset.



Application errors without status messages for TC sensor connection

Problem	Possible cause	Remedy
Measured value is incorrect/ inaccurate	Incorrect sensor orientation.	Install the sensor correctly.
	Heat conducted by sensor.	Observe the installed length of the sensor.
	Incorrect thermocouple type (TC) configured.	Change the Sensor type device function.
	Incorrect cold junction set.	Set the correct cold junction .
	Interference via the thermocouple wire welded in the thermowell (interference voltage coupling).	Use a sensor where the thermocouple wire is not welded.
	Offset incorrectly set.	Check offset.

11.2 Diagnostic information on local display

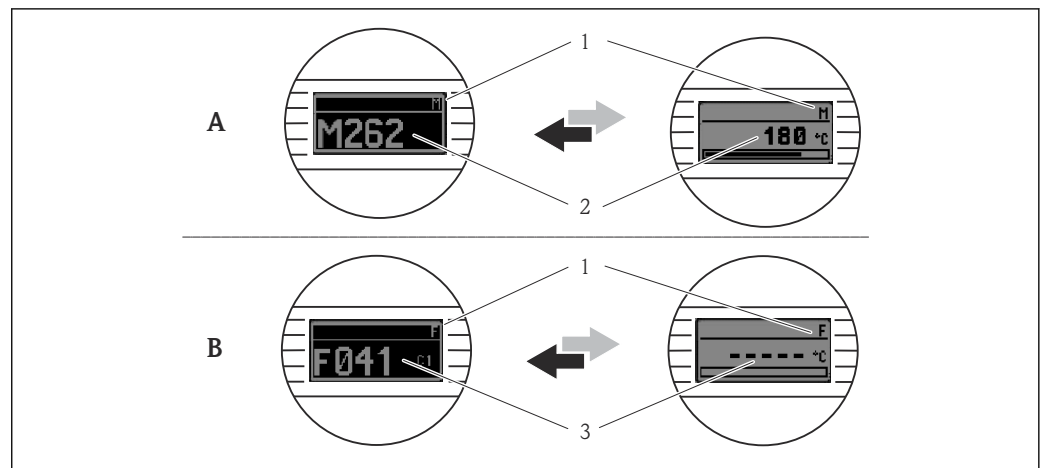

A0014837

A Display in the event of a warning

B Display in the event of an alarm

1 Status signal in the header

2 The display alternates between the primary measured value and the status - indicated by the appropriate letter (M, C or S) - plus the defined error number.

3 The display alternates between "- - -" (no valid measured value) and the status - indicated by the appropriate letter (F) - plus the defined error number.

11.3 Diagnostic information via communication interface

i The diagnostic behavior can be configured manually for certain diagnostic events. If a diagnostic event occurs, however, it is not guaranteed that the measured values are valid for the event and comply with the process for the status signals S and M and the diagnostic behavior: 'Warning' and 'Off'.

Status signals

Letter/symbol ¹⁾	Event category	Meaning
F	Failure	An operating error has occurred.
C	Function check	The device is in the service mode (e.g. during a simulation).
S	Out of specification	The device is being operated outside its technical specifications (e.g. during startup or cleaning processes).
M	Maintenance required	Maintenance is required.
-	Not categorized	

1) As per NAMUR NE107

Diagnostic behavior

Alarm	Measurement is interrupted. The signal outputs adopt the defined alarm state. A diagnostic message is generated.
Warning	The device continues to measure. A diagnostic message is generated.
Off	The diagnosis is completely disabled even if the device is not recording a measured value.
Logbook entry only	The device continues to measure. A diagnostic message is not generated. Instead only an entry is generated in the event logbook.

11.4 Overview of diagnostic events

Each diagnostic event is assigned a certain event behavior at the factory. The user can change this assignment for certain diagnostic events.

Example:

Configuration examples	Diagnostic number	Settings	Device behavior		Entry		
		Diagnostic behavior	Status signal	Process value, status	Diagnostic list	Event logbook	User interface
1. Default setting	042	Warning	M	Measured value, GOOD - maintenance required	✓	✓	M042
2. Manual setting: Warning diagnostic behavior changed to Alarm	042	Alarm	F	Measured value, BAD - maintenance alarm	✓	✓	F042
3. Manual setting: Alarm diagnostic behavior changed to Off	042	Off	-	Measured value, GOOD - ok	-	-	OK
4. Manual setting: Off diagnostic behavior changed to Logbook entry only	042	Logbook entry only	-	Measured value, GOOD - ok	-	✓	OK

11.4.1 Diagnostic list

All the diagnostic messages that are currently queued can be displayed in the **Diagnostic list** submenu.

Navigation path

Diagnostics → Diagnostic list

Diagnostic number	Short text	Remedy instructions	Status signal [from the factory]	Diagnostic behavior [from the factory]
Diagnostic of sensor				
041	Sensor 1 to 2 interrupted	1. Check electrical connection 2. Replace sensor 3. Check connection type	F	Alarm
042	Sensor 1 to 2 corroded	1. Check sensor 2. Replace sensor	M	Warning ¹⁾
043	Sensor 1 to 2 short circuit detected	1. Check electrical connection 2. Check sensor 3. Replace sensor or cable	F	Alarm
044	Sensor drift detected	1. Check sensor or main electronics 2. Replace sensor or main electronics	M	Warning ¹⁾
104	Sensor backup active	1. Check electrical connection of sensor 1 2. Check sensor 1 3. Check sensor 1 configuration	M	Warning
106	Backup not available	1. Check electrical connection of sensor 2 2. Check sensor 2 3. Check sensor 2 configuration	M	Warning
145	Compensation 1 to 2 cold junction	1. Check terminal temperature 2. Check cold junction point	F	Alarm
167	Thermowell faulty	1. Check thermowell 2. Replace thermowell	M	Warning

Diagnostic number	Short text	Remedy instructions	Status signal [from the factory]	Diagnostic behavior [from the factory]
Diagnostic of electronic				
201	Electronics faulty	1. Restart device 2. Replace electronics	F	Alarm
232	Real time clock defective	Replace main electronics	M	Warning
270	Main electronics defective	Replace main electronics	F	Alarm
272	Main electronics faulty	1. Restart device 2. Contact service	F	Alarm
287	Memory content inconsistent	1. Restart device 2. Contact service	M	Warning
321	Internal cold junction defective	Replace device	M	Warning ¹⁾
331	Firmware update failed	1. Update firmware of device 2. Restart device	M	Warning
Diagnostic of configuration				
402	Initialization sensor 1 to 2 active	Initialization in progress, please wait	C	Warning
410	Data transfer failed	1. Check connection 2. Repeat data transfer	F	Alarm
412	Processing download	Download active, please wait	S	Warning
435	Linearization sensor 1 to 2 faulty	Check linearization	F	Alarm
436	Date/time incorrect	Check date and time settings.	S	Warning ¹⁾
437	Configuration incompatible	1. Check device configuration 2. Update firmware 3. Execute factory reset	F	Alarm
438	Dataset different	1. Check dataset file 2. Check device parameterization 3. Download new device parameterization	M	Warning
484	Failure mode simulation active	Deactivate simulation	C	Alarm
485	Process variable 1 to 2 simulation active	Deactivate simulation	C	Warning
495	Diagnostic event simulation active	Deactivate simulation	S	Warning
Diagnostic of process				
811	APL connection faulty	Connect field device only to APL spur port	F	Alarm
825	Electronics temperature out of range	1. Check ambient temperature 2. Check process temperature	S	Warning ¹⁾
841	Operating range 1 to 2	1. Check sensor 2. Check process conditions	S	Warning ¹⁾

1) Diagnostic behavior can be changed.

If two or more diagnostic events occur simultaneously, only the diagnostic message with the highest priority is shown. Additional pending diagnostic messages are shown in the **Diagnostic list** submenu. The status signal dictates the priority in which the diagnostic messages are displayed. The following order of priority applies: F, C, S, M. If two or more

diagnostic events with the same status signal are active simultaneously, the numerical order of the event number dictates the order of priority in which the events are displayed, e.g.: F042 appears before F044 and before S044. Filters can be used to determine which category of event messages is displayed. The date/time of the event and the details (remedial measures) are also displayed.

Filter categories

- All
- Failure (F)
- Function check (C)
- Out of specification (S)
- Maintenance required (M)

11.5 Event logbook

Previous diagnostic messages are displayed in the **Event logbook** submenu.

11.5.1 Event history

The **Event logbook** submenu provides a chronological overview of the event messages that have occurred ¹⁾.

Navigation path

Diagnostics → Event logbook

A maximum of 100 event messages can be displayed in chronological order.

The event history includes entries for:

- Diagnostic events
- Information events

In addition to the operating time when the event occurred and the event details (remedial measures), each event is also assigned a symbol that indicates whether the event has occurred or is finished:

- Diagnostic event
 - ☉: Occurrence of the event
 - ☺: End of the event
- Information event
 - ①: Occurrence of the event



If the configuration is changed, the name of the modified parameter, the previous parameter value and the new value are displayed in addition to the operating time.

11.5.2 Filtering the event logbook

You can use filters to specify which category of event messages is displayed in the **Event logbook** submenu.

Navigation path

Diagnostics → Event logbook

Filter categories

- All
- Failure (F)
- Function check (C)
- Out of specification (S)
- Maintenance required (M)
- Information

1) If operating via FieldCare, the event list can be displayed via the "Event List" FieldCare function.

11.6 Thermowell monitoring with second process seal (dual seal)

The transmitter provides the option of detecting a tripped pressure switch in the second process seal in a iTHERM ModuLine TM131 thermometer and generating a diagnostic event. To be able to use this function, a temperature sensor (sensor input 1) and the pressure switch of the thermometer (sensor input 2) are connected and the Dual seal (ModuLine) sensor type is configured accordingly. This activates monitoring. Other settings do not need to be made. If the switch point of the pressure switch is exceeded, the transmitter outputs a diagnostic message.

Navigation path

Application → Sensor → Sensor 1/2

11.7 Firmware history

Revision history

The firmware version (FW) on the nameplate and in the Operating Instructions indicates the device release: XX.YY.ZZ (example 01.02.01).

XX	Change to main version. No longer compatible. The device and Operating Instructions change.
YY	Change to functions and operation. Compatible. The Operating Instructions change.
ZZ	Fixes and internal changes. No changes to the Operating Instructions.

Date	Firmware version	Modifications	Documentation
12/2022	01.01.zz	Original firmware	BA02144T, Version 01.22

12 Maintenance

No special maintenance work is required for the device.

Cleaning

A clean, dry cloth can be used to clean the device.

13 Repair

13.1 General information

Due to its design, the device cannot be repaired.

13.2 Spare parts

Device spare parts that are currently available can be found online at: <https://www.endress.com/en/instrumentation-services>.

Always quote the serial number of the device when ordering spare parts!

13.3 Return

The requirements for safe device return can vary depending on the device type and national legislation.

1. Refer to the web page for information:
<http://www.endress.com/support/return-material>
 ↳ Select the region.
2. Return the device if repairs or a factory calibration are required, or if the wrong device was ordered or delivered.

13.4 Disposal



If required by the Directive 2012/19/EU on waste electrical and electronic equipment (WEEE), the product is marked with the depicted symbol in order to minimize the disposal of WEEE as unsorted municipal waste. Do not dispose of products bearing this marking as unsorted municipal waste. Instead, return them to the manufacturer for disposal under the applicable conditions.

14 Accessories



Various accessories, which can be ordered with the device or subsequently from Endress+Hauser, are available for the device. Detailed information on the order code in question is available from your local Endress+Hauser sales center or on the product page of the Endress+Hauser website: www.endress.com.

14.1 Device-specific accessories

Accessories
TID10 display unit for Endress+Hauser head transmitter iTEMP TMT8x ¹⁾ , attachable
TID10 service cable; connecting cable for service interface, 40 cm (15.75 in)
Field housing TA30x for DIN flat face (form B) head transmitter
Adapter for DIN rail mounting, clip as per IEC 60715 (TH35) without securing screws
Standard - DIN mounting set (2 screws + springs, 4 securing disks and 1 display connector cover)
US - M4 mounting screws (2 M4 screws and 1 display connector cover)
Stainless steel wall mounting bracket Stainless steel pipe mounting bracket

1) Without TMT80

14.2 Communication-specific accessories

Accessories	Description
Commubox FXA291	<p>Connects Endress+Hauser field devices with a CDI interface (= Common Data Interface) and the USB port of a computer or laptop.</p> <p> For details, see Technical Information TI405C</p>
Field Xpert SMT70, SMT77	<p>Universal, high-performance tablet PC for device configuration</p> <p>The tablet PC enables mobile plant asset management in hazardous (Ex-Zone-1) and non-hazardous areas. It is suitable for commissioning and maintenance staff to manage field instruments with a digital communication interface and to record progress. This tablet PC is designed as a comprehensive, all-in-one solution. With a pre-installed driver library, it is an easy-to-use, touch-sensitive tool which can be used to manage field instruments throughout their entire life cycle.</p> <p> For details:</p> <ul style="list-style-type: none"> ■ SMT70 - Technical Information TI01342S ■ SMT77 - Technical Information TI01418S

14.3 Service-specific accessories

Device Viewer

The Device Viewer is an online tool for the device-specific selection of device information, technical documentation including device-specific documents. Using the serial number of a device, the Device Viewer displays information about the product life cycle, documents, spare parts, etc.

The Device Viewer is available: <https://portal.endress.com/webapp/DeviceViewer/>

15 Technical data

15.1 Function and system design

Measuring principle

Electronic recording and conversion of various input signals in industrial temperature measurement.

Measuring system

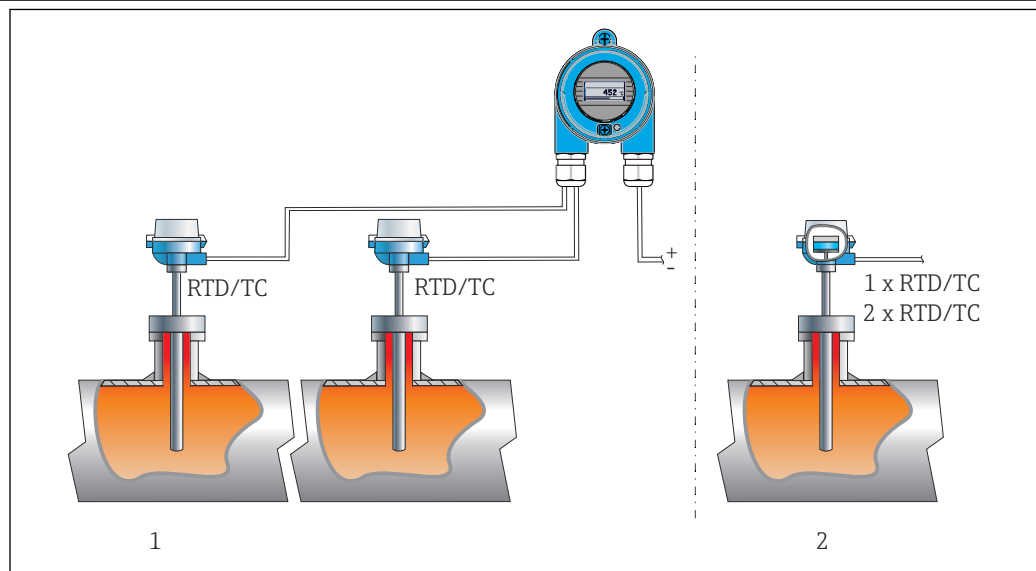

16 Application examples

- 1 Two sensors with measuring input (RTD or TC) in remote installation with the following advantages: drift warning, sensor backup function
- 2 Integrated transmitter - 1 x RTD/TC or 2 x RTD/TC for redundancy

Endress+Hauser offers a comprehensive range of industrial thermometers with resistance sensors or thermocouples.

When combined with the temperature transmitter, these components form a complete measuring point for a wide range of applications in the industrial sector.

The temperature transmitter is a 2-wire device with two measuring inputs. The device not only transfers converted signals from resistance thermometers and thermocouples, it also transfers resistance and voltage signals using the PROFINET[®] protocol. Power is supplied via the 2-wire Ethernet connection according to IEEE 802.3cg 10BASE-T1L. The transmitter can be installed as an intrinsically safe electrical apparatus in Zone 1 hazardous areas. The device can be used for instrumentation purposes in the terminal head form B (flat face) according to DIN EN 50446.

Standard diagnostic functions

- Open circuit, short-circuit, corrosion of sensor cables
- Incorrect wiring
- Internal device errors
- Overage/underrange detection
- Ambient temperature out-of-range detection

Corrosion detection as per NAMUR NE89

Corrosion of the sensor connection cables can cause incorrect measured value readings. The transmitter offers the possibility of detecting any corrosion of thermocouples, mV

transmitters and resistance thermometers, Ohm transmitters with 4-wire connection before a measured value is corrupted. The transmitter prevents incorrect measured values from being read out and can issue a warning via the PROFINET® protocol if wire resistance values exceed plausible limits.

2-channel functions

These functions increase the reliability and availability of the process values:

- Sensor backup switches to the second sensor if the primary sensor fails
- Drift warning or alarm if the deviation between sensor 1 and sensor 2 is less than or greater than a predefined limit value
- Mean value or differential measurement from two sensors

Equipment architecture

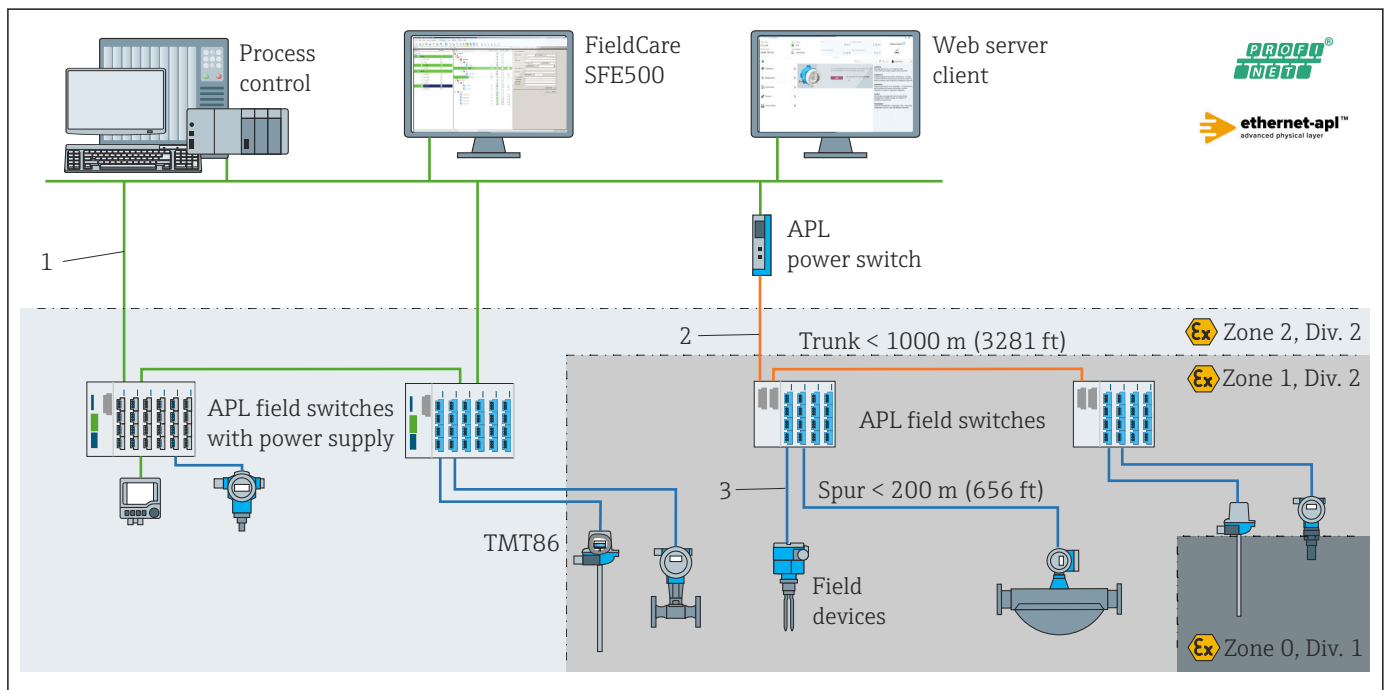

A0048925

17 Equipment architecture of the transmitter with PROFINET with Ethernet-APL communication

- 1 Facility Ethernet
- 2 Ethernet-APL with advanced safety
- 3 Ethernet-APL with intrinsic safety

Dependability

IT security

Endress+Hauser can only provide a warranty if the device is installed and used as described in the Operating Instructions. The device is equipped with security mechanisms to protect it against any inadvertent changes to the device settings. IT security measures in line with operators' security standards and designed to provide additional protection for the device and device data transfer must be implemented by the operators themselves.

Device-specific IT security

The device offers specific functions to support protective measures by the operator. These functions can be configured by the user and guarantee greater in-operation safety if used correctly. An overview of the most important functions is provided in the following section:
 Password to change the user role ²⁾

Function/interface	Factory setting	Recommendation
Password (also applies for web server login or FieldCare connection)	Not enabled (0000)	Assign an individual password when commissioning.
Web server	Enabled	On an individual basis following risk assessment.
Service interface (CDI)	Enabled	On an individual basis following risk assessment.
Write protection via hardware write protection switch (optional via display)	Not enabled	On an individual basis following risk assessment.

Protecting access via a password

Different passwords are available to protect write access to the parameters of the device. Protect write access to the parameters of the device via the web browser or operating tool (e.g. FieldCare, DeviceCare). Access authorization is clearly regulated through the use of a user-specific password.

General notes on the use of passwords

- During commissioning, change the password that was used when the device was delivered from the factory.
- Follow the general rules for generating a secure password when defining and managing the password.
- The user is responsible for the management and careful handling of the password.

Access via web server

The device can be operated and configured via a web browser with the integrated web server. For device versions with the PROFINET® communication protocol, the connection can be established via the terminal connection for signal transmission with PROFINET®.

 For detailed information on device parameters, see: "Description of Device Parameters" document

15.2 Input

Measured variable Temperature (temperature-linear transmission behavior), resistance and voltage.

Measuring range Two independent sensors can be connected. The measuring inputs are not galvanically isolated from each other.

Resistance thermometer (RTD) as per standard	Description	α	Measuring range limits
IEC 60751:2022	Pt100 (1) Pt200 (2) Pt500 (3) Pt1000 (4)	0.003851	-200 to +850 °C (-328 to +1562 °F) -200 to +850 °C (-328 to +1562 °F) -200 to +500 °C (-328 to +932 °F) -200 to +500 °C (-328 to +932 °F)
JIS C1604:1984	Pt100 (5)	0.003916	-200 to +510 °C (-328 to +950 °F)

2) FDI driver package

Resistance thermometer (RTD) as per standard	Description	α	Measuring range limits
GOST 6651-94	Pt50 (8) Pt100 (9)	0.003910	-185 to +1100 °C (-301 to +2012 °F) -200 to +850 °C (-328 to +1562 °F)
OIML R84: 2003, GOST 6651-2009	Cu50 (10) Cu100 (11)	0.004280	-180 to +200 °C (-292 to +392 °F) -180 to +200 °C (-292 to +392 °F)
OIML R84: 2003, GOST 6651-94	Cu50 (14)	0.004260	-50 to +200 °C (-58 to +392 °F)
-	Pt100 (Callendar van Dusen) Nickel polynomial Copper polynomial	-	The measuring range limits are specified by entering the limit values that depend on the coefficients A to C and R0. <ul style="list-style-type: none"> ■ Connection type: 2-wire, 3-wire or 4-wire connection, sensor current: ≤ 0.3 mA ■ With 2-wire circuit, compensation of wire resistance possible (0 to 30 Ω) ■ With 3-wire and 4-wire connection, sensor wire resistance up to max. 50 Ω per wire
Resistance transmitter	Resistance Ω		10 to 400 Ω 10 to 2 850 Ω

Thermocouples as per standard	Description	Measuring range limits	
IEC 60584, Part 1	Type A (W5Re-W20Re) (30) Type B (PtRh30-PtRh6) (31) Type E (NiCr-CuNi) (34) Type J (Fe-CuNi) (35) Type K (NiCr-Ni) (36) Type N (NiCrSi-NiSi) (37) Type R (PtRh13-Pt) (38) Type S (PtRh10-Pt) (39) Type T (Cu-CuNi) (40)	0 to +2 500 °C (+32 to +4 532 °F) 0 to +1 820 °C (+32 to +3 308 °F) ¹⁾ -250 to +1 000 °C (-418 to +1 832 °F) -210 to +1 200 °C (-346 to +2 192 °F) -270 to +1 372 °C (-454 to +2 501 °F) -270 to +1 300 °C (-454 to +2 372 °F) -50 to +1 768 °C (-58 to +3 214 °F) -50 to +1 768 °C (-58 to +3 214 °F) -200 to +400 °C (-328 to +752 °F)	Recommended temperature range: 0 to +2 500 °C (+32 to +4 532 °F) +500 to +1 820 °C (+932 to +3 308 °F) -150 to +1 000 °C (-238 to +1 832 °F) -150 to +1 200 °C (-238 to +2 192 °F) -150 to +1 200 °C (-238 to +2 192 °F) -150 to +1 300 °C (-238 to +2 372 °F) +200 to +1 768 °C (+392 to +3 214 °F) +200 to +1 768 °C (+392 to +3 214 °F) -150 to +400 °C (-238 to +752 °F)
IEC 60584, Part 1; ASTM E988-96	Type C (W5Re-W26Re) (32)	0 to +2 315 °C (+32 to +4 199 °F)	0 to +2 000 °C (+32 to +3 632 °F)
ASTM E988-96	Type D (W3Re-W25Re) (33)	0 to +2 315 °C (+32 to +4 199 °F)	0 to +2 000 °C (+32 to +3 632 °F)
DIN 43710	Type L (Fe-CuNi) (41) Type U (Cu-CuNi) (42)	-200 to +900 °C (-328 to +1 652 °F) -200 to +600 °C (-328 to +1 112 °F)	-150 to +900 °C (-238 to +1 652 °F) -150 to +600 °C (-238 to +1 112 °F)
GOST R8.585-2001	Type L (NiCr-CuNi) (43)	-200 to +800 °C (-328 to +1 472 °F)	-200 to +800 °C (+328 to +1 472 °F)
	<ul style="list-style-type: none"> ■ Internal cold junction (Pt100) ■ External preset value: configurable value -40 to +85 °C (-40 to +185 °F) ■ Maximum sensor wire resistance 10 kΩ (If the sensor wire resistance is greater than 10 kΩ, an error message is output in accordance with NAMUR NE89.) 		
Voltage transmitter (mV)	Millivolt transmitter (mV)	-20 to 100 mV	

- 1) In the undefined range between 0 °C (+32 °F) and +45 °C (+113 °F), the device will constantly output +20 °C (+68 °F) without a diagnostic message. This is intended for installation start-ups at room temperature.

15.3 Output

Output signal	PROFINET® according to IEEE 802.3cg 10BASE-T1L, 2-wire 10 Mbps
Signal on alarm	PROFINET®: according to "Application Layer protocol for decentralized periphery", Version 2.4
Linearization	Temperature-linear, resistance-linear, voltage-linear

Galvanic isolation U = 2 kV AC for 1 minute (input/output)

Protocol-specific data	Protocol	Application layer protocol for decentral device periphery and distributed automation, Version 2.4
	Communication type	10 Mbps
	Conformance Class	Conformance Class B
	Netload Class	Netload Class 10BASE-T1L
	Baud rates	Automatic 10 Mbps with full-duplex detection
	Cycle times	128 ms
	Polarity	Auto-polarity for automatic correction of crossed TxD and RxD pairs
	Real Time Class	Class 1
	Media Redundancy Protocol (MRP)	No
	System redundancy support	System redundancy S2 (4 AR with 1 NAP)
	Neighborhood detection (LLDP)	Yes
	Device profile	Profile DeviceID 0xB300 Generic device
	Manufacturer ID	0x11
	Device type ID	0xA3FF
	Device description files (GSD, FDI, EDD)	Information and files at: <ul style="list-style-type: none"> ▪ www.endress.com. On the product page for the device: Documents/Software → Device drivers ▪ www.profibus.com
Supported connections	2 x AR (IO Controller AR) 2 x AR (device access, acyclic communication)	
Configuration options	<ul style="list-style-type: none"> ▪ Manufacturer-specific software (FieldCare, DeviceCare) ▪ Web browser ▪ Device master file (GSD): can be read out via the integrated web server of the measuring device. 	
Configuration of the device label	<ul style="list-style-type: none"> ▪ DCP protocol ▪ Field Device Integration (FDI) ▪ Process Device Manager (PDM) ▪ Integrated web server 	

15.4 Performance characteristics

Response time

- ≤ 0.5 s per channel RTD
- ≤ 0.5 s per channel TC
- ≤ 1.6 s per channel CJ

In the two-channel mode, the response times double due to sequential measured value acquisition.

Reference operating conditions

- Calibration temperature: +25 °C ±3 K (77 °F ±5.4 °F)
- Supply voltage: 15 V DC
- 4-wire circuit for resistance adjustment

Maximum measured error In accordance with DIN EN 60770 and the reference conditions specified above. The measured error data corresponds to $\pm 2 \sigma$ (Gaussian distribution). The data include non-linearities and repeatability.

Typical

Standard	Description	Measuring range	Typical measured error (\pm)
Resistance thermometer (RTD) as per standard			Digital value
IEC 60751:2022	Pt100 (1)	0 to +200 °C (32 to +392 °F)	0.08 °C (0.14 °F)
IEC 60751:2022	Pt1000 (4)		0.06 °C (0.11 °F)
GOST 6651-94	Pt100 (9)		0.07 °C (0.13 °F)
Thermocouples (TC) as per standard			Digital value
IEC 60584, Part 1	Type K (NiCr-Ni) (36)	0 to +800 °C (32 to +1472 °F)	0.36 °C (0.65 °F)
IEC 60584, Part 1	Type S (PtRh10-Pt) (39)		1.01 °C (1.82 °F)
GOST R8.585-2001	Type L (NiCr-CuNi) (43)		2.35 °C (4.23 °F)

Measured error for resistance thermometers (RTD) and resistance transmitters

Standard	Description	Measuring range	Measured error (\pm)
			Based on measured value
IEC 60751:2022	Pt100 (1)	-200 to +850 °C (-328 to +1562 °F)	0.06 °C (0.11 °F) + 0.006% * (MV - LRV)
	Pt200 (2)		0.11 °C (0.2 °F) + 0.018% * (MV - LRV)
	Pt500 (3)	-200 to +500 °C (-328 to +932 °F)	0.05 °C (0.09 °F) + 0.015% * (MV - LRV)
	Pt1000 (4)	-200 to +500 °C (-328 to +932 °F)	0.03 °C (0.05 °F) + 0.013% * (MV - LRV)
JIS C1604:1984	Pt100 (5)	-200 to +510 °C (-328 to +950 °F)	0.05 °C (0.09 °F) + 0.006% * (MV - LRV)
GOST 6651-94	Pt50 (8)	-185 to +1100 °C (-301 to +2012 °F)	0.10 °C (0.18 °F) + 0.008% * (MV - LRV)
	Pt100 (9)	-200 to +850 °C (-328 to +1562 °F)	0.05 °C (0.09 °F) + 0.006% * (MV - LRV)
OIML R84: 2003 / GOST 6651-2009	Cu50 (10)	-180 to +200 °C (-292 to +1562 °F)	0.09 °C (0.16 °F) + 0.006% * (MV - LRV)
	Cu100 (11)		0.05 °C (0.09 °F) + 0.003% * (MV - LRV)
OIML R84: 2003, GOST 6651-94	Cu50 (14)	-50 to +200 °C (-58 to +392 °F)	0.09 °C (0.16 °F) + 0.004% * (MV - LRV)
Resistance transmitter	Resistance Ω	10 to 400 Ω	20 m Ω + 0.003% * (MV - LRV)
		10 to 2850 Ω	100 m Ω + 0.006% * (MV - LRV)

Measured error for thermocouples (TC) and voltage transmitters

Standard	Description	Measuring range	Measured error (\pm)
			Based on measured value
IEC 60584-1	Type A (30)	0 to +2500 °C (+32 to +4532 °F)	0.9 °C (1.62 °F) + 0.025% * (MV - LRV)
	Type B (31)	+500 to +1820 °C (+932 to +3308 °F)	1.6 °C (2.88 °F) - 0.065% * (MV - LRV)
IEC 60584-1 / ASTM E988-96	Type C (32)	0 to +2000 °C (+32 to +3632 °F)	0.6 °C (1.08 °F) + 0.0055% * MV
ASTM E988-96	Type D (33)		0.8 °C (1.44 °F) - 0.008% * MV
IEC 60584-1	Type E (34)	-150 to +1000 °C (-238 to +2192 °F)	0.25 °C (0.45 °F) - 0.008% * (MV - LRV)
	Type J (35)	-150 to +1200 °C (-238 to +2192 °F)	0.3 °C (0.54 °F) - 0.007% * (MV - LRV)
	Type K (36)	-150 to +1200 °C (-238 to +2192 °F)	0.4 °C (0.72 °F) - 0.004% * (MV - LRV)
	Type N (37)	-150 to +1300 °C (-238 to +2372 °F)	0.5 °C (0.9 °F) - 0.015% * (MV - LRV)

Standard	Description	Measuring range	Measured error (±)
	Type R (38)	+200 to +1768 °C (+392 to +3214 °F)	0.9 °C (1.62 °F) - 0.015% * MV
	Type S (39)		0.95 °C (1.71 °F) - 0.01% * MV
	Type T (40)	-150 to +400 °C (-238 to +752 °F)	0.4 °C (0.72 °F) - 0.04% * (MV - LRV)
DIN 43710	Type L (41)	-150 to +900 °C (-238 to +1652 °F)	0.31 °C (0.56 °F) - 0.01% * (MV - LRV)
	Type U (42)	-150 to +600 °C (-238 to +1112 °F)	0.35 °C (0.63 °F) - 0.03% * (MV - LRV)
GOST R8.585-2001	Type L (43)	-200 to +800 °C (-328 to +1472 °F)	2.2 °C (3.96 °F) - 0.015% * (MV - LRV)
Voltage transmitter (mV)		-20 to +100 mV	10 µV

MV = measured value

LRV = lower range value of the sensor in question

Sample calculation with Pt100, measuring range 0 to +200 °C (+32 to +392 °F), ambient temperature +25 °C (+77 °F), supply voltage 15 V:

Measured error = 0.06 °C + 0.006% x (200 °C - (-200 °C)):	0.084 °C (0.151 °F)
---	---------------------

Sample calculation with Pt100, measuring range 0 to +200 °C (+32 to +392 °F), ambient temperature +35 °C (+95 °F), supply voltage 9 V

Measured error = 0.06 °C + 0.006% x (200 °C - (-200 °C)):	0.084 °C (0.151 °F)
Influence of ambient temperature = (35 - 25) x (0.0013% x 200 °C - (-200 °C)), min. 0.003 °C	0.05 °C (0.09 °F)
Influence of supply voltage = (15 - 9) x (0.0007% x 200 °C - (-200 °C)), min. 0.005 °C	0.02 °C (0.03 °F)
Measured error: $\sqrt{(\text{Measured error}^2 + \text{Influence of ambient temperature}^2 + \text{Influence of supply voltage}^2)}$	0.10 °C (0.18 °F)

Sensor adjustment

Sensor-transmitter matching

RTD sensors are one of the most linear temperature measuring elements. Nevertheless, the output must be linearized. To significantly improve temperature measurement accuracy, the device allows the use of two methods:

- Callendar van Dusen coefficients (Pt100 resistance thermometer)

The Callendar van Dusen equation is described as:

$$R_T = R_0[1 + AT + BT^2 + C(T - 100)T^3]$$

The coefficients A, B and C are used to match the sensor (platinum) and transmitter in order to improve the accuracy of the measuring system. The coefficients for a standard sensor are specified in IEC 751. If no standard sensor is available or if greater accuracy is required, the coefficients for each sensor can be determined specifically with the aid of sensor calibration.

- Linearization for copper/nickel resistance thermometers (RTD)

The polynomial equation for copper/nickel is as follows:

$$R_T = R_0(1 + AT + BT^2)$$

The coefficients A and B are used for the linearization of nickel or copper resistance thermometers (RTD). The exact values of the coefficients derive from the calibration data and are specific to each sensor. The sensor-specific coefficients are then sent to the transmitter.

Sensor-transmitter matching using one of the methods mentioned above significantly improves the temperature measurement accuracy of the entire system. This is because the transmitter uses the specific data pertaining to the connected sensor to calculate the measured temperature, instead of using the standardized sensor curve data.

Operating influences The measured error data corresponds to $\pm 2 \sigma$ (Gaussian distribution).

Influence of ambient temperature and supply voltage on operation for resistance thermometers (RTD) and resistance transmitters

Description	Standard	Ambient temperature: Influence (\pm) per 1 °C (1.8 °F) change		Supply voltage: Influence (\pm) per 1 V change	
		Digital		Digital	
		Maximum	Based on measured value	Maximum	Based on measured value
Pt100 (1)	IEC 60751:2022	≤ 0.013 °C (0.023 °F)	0.0013% * (MV - LRV), at least 0.002 °C (0.004 °F)	≤ 0.007 °C (0.013 °F)	0.0007% * (MV - LRV), at least 0.002 °C (0.004 °F)
Pt200 (2)		≤ 0.017 °C (0.031 °F)	0.002% * (MV - LRV), at least 0.012 °C (0.022 °F)	≤ 0.009 °C (0.016 °F)	0.001% * (MV - LRV), at least 0.008 °C (0.014 °F)
Pt500 (3)		≤ 0.008 °C (0.014 °F)	0.0013% * (MV - LRV), at least 0.005 °C (0.009 °F)	≤ 0.004 °C (0.007 °F)	0.0007% * (MV - LRV), at least 0.003 °C (0.005 °F)
Pt1000 (4)		≤ 0.008 °C (0.014 °F)	0.0013% * (MV - LRV), at least 0.002 °C (0.004 °F)		0.0007% * (MV - LRV), at least 0.002 °C (0.004 °F)
Pt100 (5)	JIS C1604:1984	≤ 0.009 °C (0.016 °F)	0.0015% * (MV - LRV), at least 0.002 °C (0.004 °F)	≤ 0.009 °C (0.016 °F)	0.0007% * (MV - LRV), at least 0.002 °C (0.004 °F)
Pt50 (8)	GOST 6651-94	≤ 0.017 °C (0.031 °F)	0.0015% * (MV - LRV), at least 0.005 °C (0.009 °F)		0.0007% * (MV - LRV), at least 0.003 °C (0.005 °F)
Pt100 (9)		≤ 0.013 °C (0.023 °F)	0.0015% * (MV - LRV), at least 0.002 °C (0.004 °F)	≤ 0.007 °C (0.013 °F)	0.0007% * (MV - LRV), at least 0.002 °C (0.004 °F)
Cu50 (10)	OIML R84: 2003 / GOST 6651-2009	≤ 0.005 °C (0.009 °F)	0.001% * (MV - LRV), at least 0.004 °C (0.007 °F)	≤ 0.002 °C (0.004 °F)	0.0007% * (MV - LRV), at least 0.003 °C (0.005 °F)
Cu100 (11)		≤ 0.004 °C (0.007 °F)	0.0015% * (MV - LRV), at least 0.002 °C (0.004 °F)		0.0007% * (MV - LRV), at least 0.002 °C (0.004 °F)
Cu50 (14)	OIML R84: 2003 / GOST 6651-94	≤ 0.005 °C (0.009 °F)	0.002% * (MV - LRV), at least 0.005 °C (0.009 °F)	≤ 0.002 °C (0.004 °F)	0.0007% * (MV - LRV), at least 0.003 °C (0.005 °F)
Resistance transmitter (Ω)					
10 to 400 Ω		≤ 4 m Ω	0.001% * MV, at least 1 m Ω	≤ 2 m Ω	0.0005% * MV, at least 1 m Ω
10 to 2850 Ω		≤ 29 m Ω	0.001% * MV, at least 10 m Ω	≤ 14 m Ω	0.0005% * MV, at least 5 m Ω

Influence of ambient temperature and supply voltage on operation for thermocouples (TC) and voltage transmitters

Description	Standard	Ambient temperature: Influence (\pm) per 1 °C (1.8 °F) change		Supply voltage: Influence (\pm) per 1 V change	
		Digital		Digital	
		Maximum	Based on measured value	Maximum	Based on measured value
Type A (30)	IEC 60584-1/ ASTM E230-3	≤ 0.07 °C (0.13 °F)	0.003% * (MV - LRV), at least 0.01 °C (0.018 °F)	≤ 0.03 °C (0.054 °F)	0.0014% * (MV - LRV), at least 0.01 °C (0.018 °F)
Type B (31)		≤ 0.04 °C (0.07 °F)	-	≤ 0.02 °C (0.036 °F)	-
Type C (32)	IEC 60584-1 / ASTM E230-3 ASTM E988-96	≤ 0.04 °C (0.07 °F)	0.0021% * (MV - LRV), at least 0.01 °C (0.018 °F)	≤ 0.02 °C (0.036 °F)	0.0012% * (MV - LRV), at least 0.01 °C (0.018 °F)

Description	Standard	Ambient temperature: Influence (±) per 1 °C (1.8 °F) change		Supply voltage: Influence (±) per 1 V change	
		Digital		Digital	
Type D (33)	ASTM E988-96	≤ 0.04 °C (0.07 °F)	0.002% * (MV - LRV), at least 0.01 °C (0.018 °F)	≤ 0.02 °C (0.036 °F)	0.0011% * (MV - LRV), at least 0.0 °C (0.0 °F)
Type E (34)	IEC 60584-1 / ASTM E230-3	≤ 0.02 °C (0.036 °F)	0.0014% * (MV - LRV), at least 0.0 °C (0.0 °F)	≤ 0.01 °C (0.018 °F)	0.0008% * (MV - LRV), at least 0.0 °C (0.0 °F)
Type J (35)			0.0014% * (MV - LRV), at least 0.0 °C (0.0 °F)		0.0008% * MV, at least 0.0 °C (0.0 °F)
Type K (36)		≤ 0.02 °C (0.036 °F)	0.0015% * (MV - LRV), at least 0.0 °C (0.0 °F)	≤ 0.01 °C (0.018 °F)	0.0009% * (MV - LRV), at least 0.0 °C (0.0 °F)
Type N (37)			0.0014% * (MV - LRV), at least 0.010 °C (0.018 °F)		0.0008% * MV, at least 0.0 °C (0.0 °F)
Type R (38)		≤ 0.03 °C (0.054 °F)	-	≤ 0.02 °C (0.036 °F)	-
Type S (39)			-		-
Type T (40)		DIN 43710	≤ 0.01 °C (0.018 °F)	-	0.01 °C (0.018 °F)
Type L (41)	-			-	
Type U (42)	-			-	
Type L (43)	GOST R8.585-2001			-	
Voltage transmitter (mV)					
-20 to 100 mV	-	≤ 1.5 µV	0.0015% * MV, at least 0.2µV	≤ 0.8 µV	0.0008% * MV, at least 0.1 µV

MV = measured value

LRV = lower range value of the sensor in question

Long-term drift, resistance thermometers (RTD) and resistance transmitters

Description	Standard	Long-term drift (±) ¹⁾		
		after 1 year	after 3 years	after 5 years
		Based on measured value		
Pt100 (1)	IEC 60751:2022	≤ 0.007% * (MV - LRV) or 0.02 °C (0.04 °F)	≤ 0.0095% * (MV - LRV) or 0.03 °C (0.05 °F)	≤ 0.0105% * (MV - LRV) or 0.03 °C (0.05 °F)
Pt200 (2)		≤ 0.008% * (MV - LRV) or 0.08 °C (0.14 °F)	≤ 0.0105% * (MV - LRV) or 0.10 °C (0.18 °F)	≤ 0.0115% * (MV - LRV) or 0.04 °C (0.07 °F)
Pt500 (3)		≤ 0.006% * (MV - LRV) or 0.02 °C (0.04 °F)	≤ 0.008% * (MV - LRV) or 0.04 °C (0.07 °F)	≤ 0.009% * (MV - LRV) or 0.04 °C (0.07 °F)
Pt1000 (4)		≤ 0.006% * (MV - LRV) or 0.02 °C (0.04 °F)	≤ 0.008% * (MV - LRV) or 0.02 °C (0.04 °F)	≤ 0.009% * (MV - LRV) or 0.02 °C (0.04 °F)
Pt100 (5)	JIS C1604:1984	≤ 0.007% * (MV - LRV) or 0.02 °C (0.04 °F)	≤ 0.0095% * (MV - LRV) or 0.03 °C (0.05 °F)	≤ 0.0105% * (MV - LRV) or 0.03 °C (0.05 °F)
Pt50 (8)	GOST 6651-94	≤ 0.0075% * (MV - LRV) or 0.04 °C (0.08 °F)	≤ 0.01% * (MV - LRV) or 0.06 °C (0.11 °F)	≤ 0.011% * (MV - LRV) or 0.07 °C (0.12 °F)
Pt100 (9)		≤ 0.007% * (MV - LRV) or 0.02 °C (0.04 °F)	≤ 0.0095% * (MV - LRV) or 0.03 °C (0.05 °F)	≤ 0.0105% * (MV - LRV) or 0.03 °C (0.05 °F)
Cu50 (10)	OIML R84: 2003 / GOST 6651-2009	0.04 °C (0.07 °F)	0.05 °C (0.09 °F)	0.05 °C (0.09 °F)
Cu100 (11)		≤ 0.007% * (MV - LRV) or 0.02 °C (0.04 °F)	≤ 0.0095% * (MV - LRV) or 0.03 °C (0.05 °F)	≤ 0.0105% * (MV - LRV) or 0.03 °C (0.05 °F)
Cu50 (14)	OIML R84: 2003 / GOST 6651-94	0.04 °C (0.07 °F)	0.05 °C (0.09 °F)	0.05 °C (0.09 °F)

Description	Standard	Long-term drift (\pm) ¹⁾		
Resistance transmitter				
10 to 400 Ω		$\leq 0.0055\% * MV$ or 7 m Ω	$\leq 0.0075\% * MV$ or 10 m Ω	$\leq 0.008\% * (MV - LRV)$ or 11 m Ω
10 to 2850 Ω		$\leq 0.0055\% * (MV - LRV)$ or 50 m Ω	$\leq 0.0065\% * (MV - LRV)$ or 60 m Ω	$\leq 0.007\% * (MV - LRV)$ or 70 m Ω

1) The larger value is valid

Long-term drift, thermocouples (TC) and voltage transmitters

Description	Standard	Long-term drift (\pm) ¹⁾			
		after 1 year	after 3 years	after 5 years	
		Based on measured value			
Type A (30)	IEC 60584-1 / ASTM E230-3	$\leq 0.044\% * (MV - LRV)$ or 0.70 °C (1.26 °F)	$\leq 0.058\% * (MV - LRV)$ or 0.95 °C (1.71 °F)	$\leq 0.063\% * (MV - LRV)$ or 1.05 °C (1.89 °F)	
Type B (31)		1.70 °C (3.06 °F)	2.20 °C (3.96 °F)	2.40 °C (4.32 °F)	
Type C (32)	IEC 60584-1 / ASTM E230-3 ASTM E988-96	0.70 °C (1.26 °F)	0.95 °C (1.71 °F)	1.00 °C (1.80 °F)	
Type D (33)	ASTM E988-96	0.90 °C (1.62 °F)	1.15 °C (2.07 °F)	1.30 °C (2.34 °F)	
Type E (34)	IEC 60584-1 / ASTM E230-3	0.30 °C (0.54 °F)	0.35 °C (0.63 °F)	0.45 °C (0.81 °F)	
Type J (35)			0.40 °C (0.72 °F)	0.44 °C (0.79 °F)	
Type K (36)			0.40 °C (0.72 °F)	0.50 °C (0.90 °F)	0.50 °C (0.90 °F)
Type N (37)			0.55 °C (0.99 °F)	0.70 °C (1.26 °F)	0.75 °C (1.35 °F)
Type R (38)			1.30 °C (2.34 °F)	1.70 °C (3.06 °F)	1.85 °C (3.33 °F)
Type S (39)			0.40 °C (0.72 °F)	0.50 °C (0.90 °F)	0.55 °C (0.99 °F)
Type T (40)	DIN 43710	0.25 °C (0.45 °F)	0.35 °C (0.63 °F)	0.40 °C (0.72 °F)	
Type L (41)			0.40 °C (0.72 °F)	0.55 °C (0.99 °F)	
Type U (42)	GOST R8.585-2001	0.30 °C (0.54 °F)	0.40 °C (0.72 °F)	0.45 °C (0.81 °F)	
Type L (43)			0.40 °C (0.72 °F)	0.45 °C (0.81 °F)	
Voltage transmitter (mV)					
-20 to 100 mV		$\leq 0.025\% * MV$ or 8 μV	$\leq 0.033\% * MV$ or 11 μV	$\leq 0.036\% * MV$ or 12 μV	

1) The larger value is valid

Influence of the cold junction

Pt100 DIN IEC 60751 Cl. B (internal cold junction with thermocouples TC)



A 2-wire Pt1000 resistor must be used for external cold junction measurement. The Pt1000 must be positioned directly at the sensor terminals of the device, as the temperature difference between the Pt1000 and the terminal must be added to the measured error of the sensor element and sensor input Pt1000.

15.5 Environment

Ambient temperature range	<ul style="list-style-type: none"> ■ -40 to +85 °C (-40 to +185 °F), for hazardous areas see Ex documentation ■ -50 to +85 °C (-58 to +185 °F), for hazardous areas see Ex documentation, Product Configurator order code for "Test, certificate, declaration", option "JM" ³⁾ ■ -52 to +85 °C (-62 to +185 °F), for hazardous areas see Ex documentation, Product Configurator order code for "Test, certificate, declaration", option "JN" ³⁾
Storage temperature	-52 to +100 °C (-62 to +212 °F)
Operating altitude	Up to 4000 m (4374.5 yards) above mean sea level as per IEC 61010-1, CAN/CSA C22.2 No. 61010-1
Relative humidity	<ul style="list-style-type: none"> ■ Condensation permitted as per IEC 60 068-2-33 ■ Max. rel. humidity: 95% as per IEC 60068-2-30
Climate class	<p>C1 as per EN 60654-1</p> <ul style="list-style-type: none"> ■ Temperature: -5 to +45 °C (+23 to +113 °F) ■ Relative humidity: 5 to 95 %
Degree of protection	<ul style="list-style-type: none"> ■ Head transmitter with screw or push-in terminals: IP 20. In the installed state, it depends on the terminal head or field housing used. ■ When installing in field housing TA30A, TA30D or TA30H: IP 66/67 (NEMA Type 4x encl.)
Shock and vibration resistance	<p>Shock as per DIN EN 60068-2-27</p> <p>Vibration resistance as per DNVGL-CG-0339 : 2015 and DIN EN 60068-2-6: 2 to 100 Hz at 4g</p>
Electromagnetic compatibility (EMC)	<p>CE conformity</p> <p>Electromagnetic compatibility in accordance with all the relevant requirements of the IEC/EN 61326 series and NAMUR Recommendation EMC (NE21). For details, refer to the Declaration of Conformity.</p> <p>Maximum measured error <1% of measuring range.</p> <p>Interference immunity as per IEC/EN 61326 series, industrial requirements</p> <p>Interference emission as per IEC/EN 61326 series, Class B equipment</p>
Overvoltage category	Measuring category II as per IEC 61010-1. The measuring category is provided for measuring on power circuits that are directly connected electrically with the low-voltage network.
Pollution degree	Pollution degree 2 as per IEC 61010-1.
Insulation class	Class III

3) If the temperature is below -40 °C (-40 °F), increased failure rates are likely.

15.6 Mechanical construction

Design, dimensions

Dimensions in mm (in)

Head transmitter

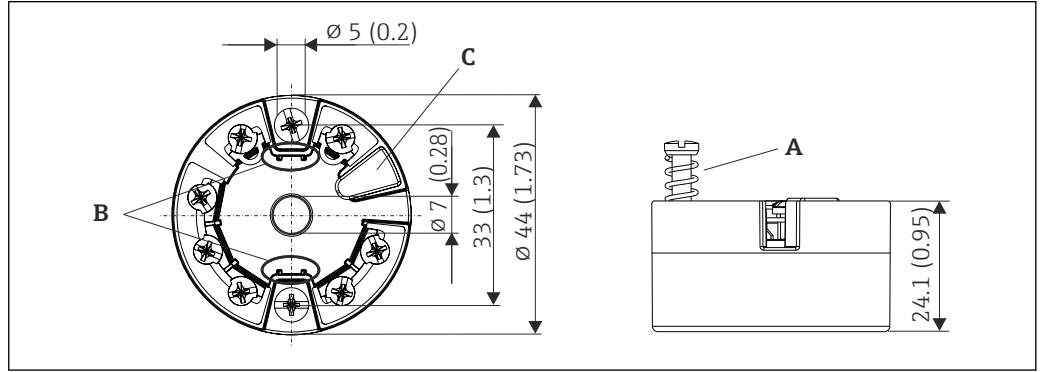

18 Version with screw terminals

A Spring travel $L \geq 5$ mm (not for US - M4 securing screws)

B Mounting elements for attachable measured value display TID10

C Service interface for connecting measured value display or configuration tool

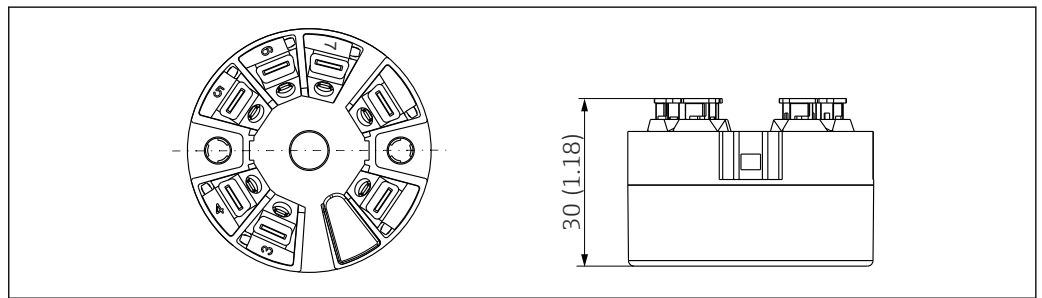

19 Version with push-in terminals. Dimensions are identical to the version with screw terminals, apart from housing height.

Field housing

All field housings have an internal geometry in accordance with DIN EN 50446, form B (flat face). Cable glands in the diagrams: M20x1.5

Maximum ambient temperatures for cable glands	
Type	Temperature range
Polyamide cable gland ½" NPT, M20x1.5 (non-Ex)	-40 to +100 °C (-40 to 212 °F)
Polyamide cable gland M20x1.5 (for dust ignition-proof area)	-20 to +95 °C (-4 to 203 °F)
Brass cable gland ½" NPT, M20x1.5 (for dust ignition-proof area)	-20 to +130 °C (-4 to +266 °F)

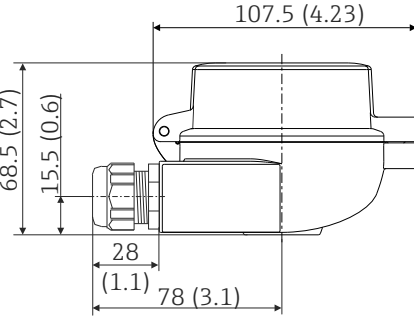
TA30A	Specification
 <p style="text-align: right; font-size: small;">A0009820</p>	<ul style="list-style-type: none"> ■ Two cable entries ■ Material: aluminum, polyester powder coated Seals: silicone ■ Degree of protection: <ul style="list-style-type: none"> ■ IP66/68 (NEMA Type 4x encl.) ■ For ATEX: IP66/67 ■ Cable entry glands: ½" NPT and M20x1.5 ■ Head color: blue, RAL 5012 ■ Cap color: gray, RAL 7035 ■ Weight: 330 g (11.64 oz)

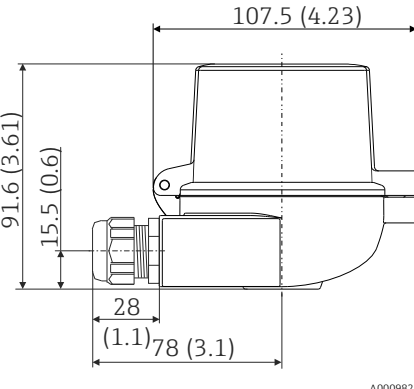
TA30A with display window in cover	Specification
 <p style="text-align: right; font-size: small;">A0009821</p>	<ul style="list-style-type: none"> ■ Two cable entries ■ Material: aluminum, polyester powder coated Seals: silicone ■ Degree of protection: <ul style="list-style-type: none"> ■ IP66/68 (NEMA Type 4x encl.) ■ For ATEX: IP66/67 ■ Cable entry glands: ½" NPT and M20x1.5 ■ Head color: blue, RAL 5012 ■ Cap color: gray, RAL 7035 ■ Weight: 420 g (14.81 oz) ■ Display window: single-pane safety glass according to DIN 8902 ■ For TID10 display

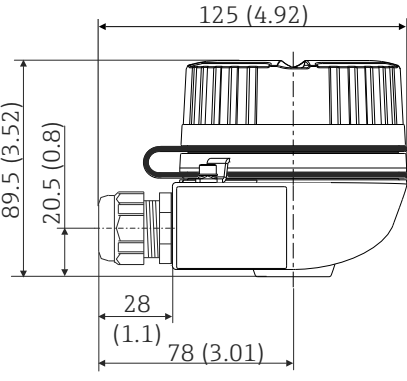
TA30H	Specification
 <p style="text-align: right; font-size: small;">A0009832</p>	<ul style="list-style-type: none"> ■ Flameproof (XP) version, explosion-protected, captive screw cap, with two cable entries ■ Degree of protection: IP 66/68, NEMA Type 4x Encl. Ex-version: IP 66/67 ■ Material: <ul style="list-style-type: none"> ■ Aluminum, with polyester powder coating ■ Stainless steel 316L without coating ■ Cable entry glands: ½" NPT, M20x1.5 ■ Color of aluminum head: blue, RAL 5012 ■ Color of aluminum cap: gray, RAL 7035 ■ Weight: <ul style="list-style-type: none"> ■ Aluminum approx. 640 g (22.6 oz) ■ Stainless steel approx. 2 400 g (84.7 oz)

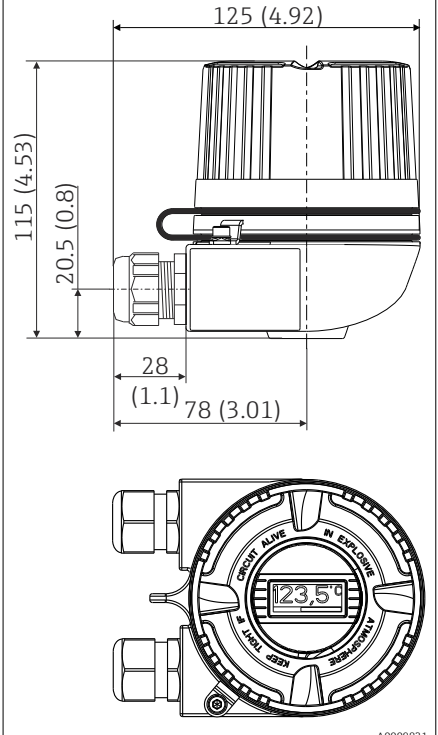
TA30H with display window in cover	Specification
	<ul style="list-style-type: none"> ▪ Flameproof (XP) version, explosion-protected, captive screw cap, with two cable entries ▪ Degree of protection: IP 66/68, NEMA Type 4x Encl. Ex-version: IP 66/67 ▪ Material: <ul style="list-style-type: none"> ▪ Aluminum with polyester powder coating ▪ Stainless steel 316L without coating ▪ Display window: single-pane safety glass according to DIN 8902 ▪ Cable entry glands: ½" NPT, M20x1.5 ▪ Color of aluminum head: blue, RAL 5012 ▪ Color of aluminum cap: gray, RAL 7035 ▪ Weight: <ul style="list-style-type: none"> ▪ Aluminum approx. 860 g (30.33 oz) ▪ Stainless steel approx. 2 900 g (102.3 oz) ▪ For TID10 display

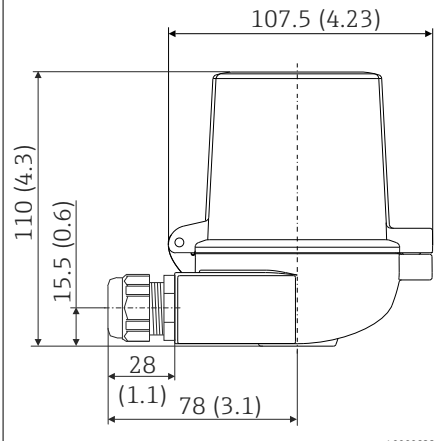
TA30D	Specification
	<ul style="list-style-type: none"> ▪ 2 cable entries ▪ Material: aluminum, polyester powder coated Seals: silicone ▪ Degree of protection: <ul style="list-style-type: none"> ▪ IP66/68 (NEMA Type 4x encl.) ▪ For ATEX: IP66/67 ▪ Cable entry glands: ½" NPT and M20x1.5 ▪ Two head transmitters can be mounted. In the standard configuration one transmitter is mounted in the terminal head cover and an additional terminal block is installed directly on the insert. ▪ Head color: blue, RAL 5012 ▪ Cap color: gray, RAL 7035 ▪ Weight: 390 g (13.75 oz)

Weight

- Head transmitter: approx. 40 to 50 g (1.4 to 1.8 oz)
- Field housing: see specifications

Materials

All the materials used are RoHS-compliant.

- Housing: Polycarbonate (PC), complies with UL94 HB (fire resistance properties)
- Terminals:
 - Screw terminals: nickel-plated brass and gold-plated or tin-plated contacts
 - Push-in terminals: tin-plated brass, contact springs 1.4310, 301 (AISI)
- Potting: QSIL 553

Field housing: see specifications

15.7 Operability

Operating concept

Operator-oriented menu structure for user-specific tasks

- Commissioning
- Operation
- Maintenance

Fast and safe commissioning

- Guided operation: commissioning wizards for applications
- Menu guidance with short explanations of the individual parameter functions
- Access to the device via web server

Reliable operation

Uniform operating concept in all operating tools

Efficient diagnostic possibilities increase measurement availability

- Troubleshooting measures can be called up in the operating tools
- Variety of simulation options and logbook of events that have occurred

Local operation

Head transmitter

The head transmitter has no display or operating elements. There is the option of using the attachable measured value display TID10 together with the head transmitter. The display provides plain-text information on the current measured value and the measuring point identification. In the event of a fault in the measurement chain, this will be displayed in inverse color showing the channel ident and error number. DIP switches can be found on the rear of the display. These enable hardware settings to be made e.g. write protection.

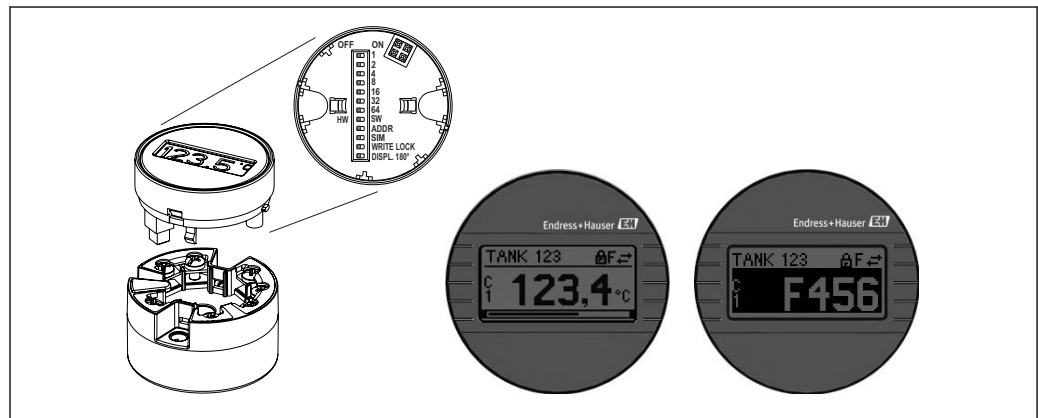

20 Attachable measured value display TID10 with bar graph indicator (optional)

i If the head transmitter is installed in a field housing and used with a display, an enclosure with a glass window in the cover must be used.

Remote operation

- PROFINET with Ethernet-APL
- Web server
- Service interface

System integration

PROFINET® Profile 4.0

Supported operating tools Different operating tools can be used for local or remote access to the measuring device. Depending on the operating tool used, access is possible with different operating units and interfaces.

Configuration software
Endress+Hauser FieldCare, DeviceCare, Field Xpert (FDI/iDTM)
SIMATIC PDM (FDI)
Field Information Manager / FIM (FDI)
Honeywell Field Device Manager (FDI)

Where to obtain GSD files and device drivers:

- GSD file: www.endress.com (→ Download → Device drivers)
- GSD file: download from the web server
- Profile GSD file: www.profibus.com
- FDI, FDI/iDTM: www.endress.com (→ Download → Device drivers)

15.8 Certificates and approvals

Current certificates and approvals that are available for the product can be selected via the Product Configurator at www.endress.com:

1. Select the product using the filters and search field.
2. Open the product page.
3. Select **Configuration**.

Certification PROFINET®-APL

The temperature transmitter is certified and registered by the PNO (PROFIBUS Nutzerorganisation e.V. /PROFIBUS User Organization). The device meets the requirements of the following specifications.

- Certified according to:
 - Test specification for PROFINET® devices
 - PROFINET® Security Level – Netload Class
- The device can also be operated with certified devices of other manufacturers (interoperability). The device supports PROFINET® S2 system redundancy.

MTTF

95 years

The mean time to failure (MTTF) denotes the theoretically expected time until the device fails during normal operation. The term MTTF is used for systems that cannot be repaired, e.g. temperature transmitters.

15.9 Ordering information

Detailed ordering information is available from your nearest sales organization www.addresses.endress.com or in the Product Configurator at www.endress.com:

1. Select the product using the filters and search field.
2. Open the product page.

3. Select **Configuration**.



Product Configurator - the tool for individual product configuration

- Up-to-the-minute configuration data
- Depending on the device: Direct input of measuring point-specific information such as measuring range or operating language
- Automatic verification of exclusion criteria
- Automatic creation of the order code and its breakdown in PDF or Excel output format
- Ability to order directly in the Endress+Hauser Online Shop

15.10 Supplementary documentation

The following types of documentation are available on the product pages and in the Download Area of the Endress+Hauser website (www.endress.com/downloads) (depending on the selected device version):

Document	Purpose and content of the document
Technical Information (TI)	Planning aid for your device The document contains all the technical data on the device and provides an overview of the accessories and other products that can be ordered for the device.
Brief Operating Instructions (KA)	Guide that takes you quickly to the 1st measured value The Brief Operating Instructions contain all the essential information from incoming acceptance to initial commissioning.
Operating Instructions (BA)	Your reference document The Operating Instructions contain all the information that is required in various phases of the life cycle of the device: from product identification, incoming acceptance and storage, to mounting, connection, operation and commissioning through to troubleshooting, maintenance and disposal.
Description of Device Parameters (GP)	Reference for your parameters The document provides a detailed explanation of each individual parameter. The description is aimed at those who work with the device over the entire life cycle and perform specific configurations.
Safety Instructions (XA)	Depending on the approval, Safety Instructions (XA) are supplied with the device. The Safety Instructions are an integral part of the Operating Instructions. Information on the Safety Instructions (XA) that are relevant for the device is provided on the nameplate.
Supplementary device-dependent documentation (SD/FY)	Always comply strictly with the instructions in the relevant supplementary documentation. The supplementary documentation is an integral part of the device documentation.

Index

A

Accessories	
Communication-specific	51
Device-specific	50

C

Connection combinations	18
-----------------------------------	----

D

DeviceCare	
User interface	37
Diagnostic events	
Diagnostic behavior	45
Overview	46
Status signals	45
Diagnostic list	46

E

Event history	48
Event list	48

F

FieldCare	
Function scope	37
User interface	39
Filtering the event logbook	48

I

Intended use	7
------------------------	---

M

Mounting location	
DIN rail (DIN rail clip)	11
Field housing	11
Terminal head, flat face as per DIN 43729	11

N

Nameplate	10
---------------------	----

O

Operating tools	29
Operation options	
Local operation	20
Operating tool	20
Overview	20

P

Product safety	8
PROFINET protocol	30

R

Requirements concerning the staff	7
Return	50

S

Service interface (CDI)	30
Solid wire	18

Structure of operating menu	23
Submenu	
Event list	48
System redundancy S2	34

T

Terminal assignment	15
Troubleshooting	
Application error with RTD sensor connection	44
Application error with TC sensor connection	44
Checking the display	43
General errors	43

V

Version data for the device	31
---------------------------------------	----

W

Wire without wire end ferrule	19
Workplace safety	7



www.addresses.endress.com
