

Operating Instructions

Modular thermometers

Universal modular thermometers with RTD or TC insert for industrial applications

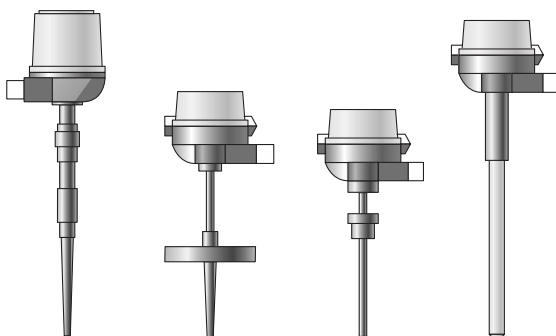

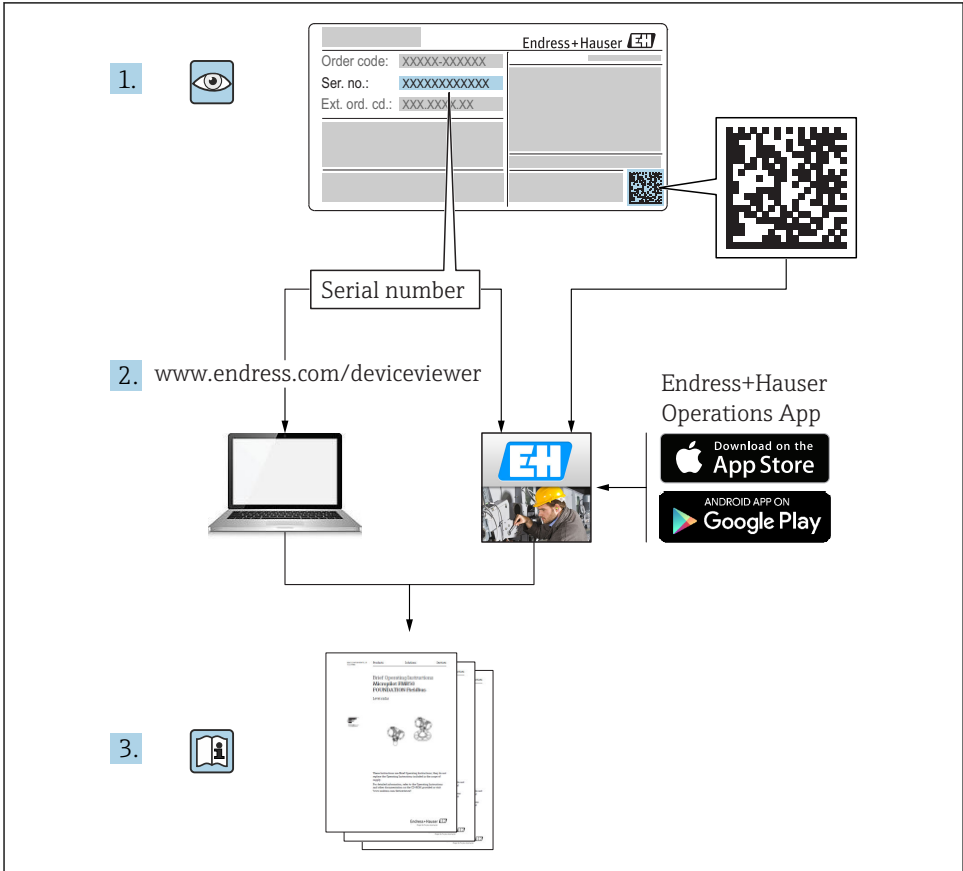

A0023555

Table of contents

1	About this document	4
1.1	Document function	4
1.2	Symbols used	4
2	Basic safety instructions	7
2.1	Requirements for the personnel	7
2.2	Designated use	7
2.3	Occupational safety	8
2.4	Operational safety	8
2.5	Product safety	9
3	Incoming acceptance and product identification	9
3.1	Incoming acceptance	9
3.2	Product identification	9
3.3	Storage and transport	11
4	Installation	12
4.1	Installation conditions	12
4.2	Installing the thermometer	13
4.3	Ensuring the degree of protection	14
5	Electrical connection	15
5.1	Wiring diagram for RTD	16
5.2	Wiring diagram for TC	16
6	Maintenance	17
6.1	Cleaning	17
6.2	Endress+Hauser services	17
7	Repair	17
7.1	Spare parts	17
8	Accessories	18
8.1	Service-specific accessories	18
9	Technical data	18
9.1	Output	18
9.2	Power supply	19
9.3	Environment	19
9.4	Certificates and approvals	20
9.5	Supplementary documentation	21

1 About this document

1.1 Document function

These Operating Instructions provide all of the information that is required in various phases of the life cycle of the device including:

- Product identification
- Incoming acceptance
- Storage
- Installation
- Connection
- Operation
- Commissioning
- Troubleshooting
- Maintenance
- Disposal

1.2 Symbols used

1.2.1 Safety symbols

DANGER

This symbol alerts you to a dangerous situation. Failure to avoid this situation will result in serious or fatal injury.

WARNING

This symbol alerts you to a dangerous situation. Failure to avoid this situation can result in serious or fatal injury.



CAUTION



This symbol alerts you to a dangerous situation. Failure to avoid this situation can result in minor or medium injury.

NOTICE













This symbol contains information on procedures and other facts which do not result in personal injury.

1.2.2 Electrical symbols



Symbol	Meaning
	Direct current
	Alternating current
	Direct current and alternating current

Symbol	Meaning
	<p>Ground connection</p> <p>A grounded terminal which, as far as the operator is concerned, is grounded via a grounding system.</p>
	<p>Protective Earth (PE)</p> <p>A terminal which must be connected to ground prior to establishing any other connections.</p> <p>The ground terminals are situated inside and outside the device:</p> <ul style="list-style-type: none"> ▪ Inner ground terminal: Connects the protective earth to the mains supply. ▪ Outer ground terminal: Connects the device to the plant grounding system.

1.2.3 Symbols for certain types of information

Symbol	Meaning
	<p>Permitted</p> <p>Procedures, processes or actions that are permitted.</p>
	<p>Preferred</p> <p>Procedures, processes or actions that are preferred.</p>
	<p>Forbidden</p> <p>Procedures, processes or actions that are forbidden.</p>
	<p>Tip</p> <p>Indicates additional information.</p>
	Reference to documentation.
	Reference to page.
	Reference to graphic.
	Notice or individual step to be observed.
	Series of steps.
	Result of a step.
	Help in the event of a problem.
	Visual inspection.

1.2.4 Symbols in graphics

Symbol	Meaning	Symbol	Meaning
1, 2, 3,...	Item numbers		Series of steps
A, B, C, ...	Views	A-A, B-B, C-C, ...	Sections
	Hazardous area		Safe area (non-hazardous area)

2 Basic safety instructions

2.1 Requirements for the personnel

The personnel for installation, commissioning, diagnostics and maintenance must fulfill the following requirements:

- ▶ Trained, qualified specialists must have a relevant qualification for this specific function and task.
- ▶ Are authorized by the plant owner/operator.
- ▶ Are familiar with federal/national regulations.
- ▶ Before starting work, read and understand the instructions in the manual and supplementary documentation as well as the certificates (depending on the application).
- ▶ Follow instructions and comply with basic conditions.

The operating personnel must fulfill the following requirements:

- ▶ Are instructed and authorized according to the requirements of the task by the facility's owner-operator.
- ▶ Follow the instructions in this manual.

2.2 Designated use

The thermometers described here are suitable for temperature measurement in industrial and hygienic applications. Depending on the version, these thermometers can be installed either in the process in direct contact with the medium, or in a thermowell. The thermowell designs are configurable. However, the process parameters (temperature, pressure, density and flow velocity) must be taken into account. It is the responsibility of the operator to select the thermometer and thermowell, in particular the material used, to ensure safe operation of the temperature measuring point.



The manufacturer is not liable for damage caused by improper or non-designated use.



The process-wetted materials of the measuring device must have an adequate level of resistance to the media.

Incorrect use



The manufacturer is not liable for damage caused by improper or non-designated use.

For special fluids and fluids for cleaning, Endress+Hauser is glad to provide assistance in verifying the corrosion resistance of process-wetted materials, but does not accept any warranty or liability.

Residual risks



Contact with surfaces presents a burn hazard! When in operation, the housing may reach a temperature close to the process temperature.

- ▶ At elevated process temperatures, protection against contact must be ensured in order to prevent burns.

2.3 Occupational safety

CAUTION

Contact with hazardous media, as well as extreme temperatures (hot or cold), may result in personal injury and damage to property and the environment. In the event of a fault, it is possible that aggressive media under extreme pressure and/or at extreme temperatures may be present at the thermometer and in the terminal head.

- ▶ The general guidelines for handling the substances, along with the relevant regulations and standards, must be observed. The appropriate protective equipment must be worn.

If working on and with the device with wet hands:

- ▶ Due to the increased risk of electric shock, gloves must be worn.

2.4 Operational safety

CAUTION

Risk of injury!

- ▶ Operate the device in proper technical condition and fail-safe condition only.
- ▶ The operator is responsible for the interference-free operation of the device.

Modifications to the device

Unauthorized modifications to the device are not permitted and can lead to unforeseeable dangers:

- ▶ If, despite this, modifications are required, consult with Endress+Hauser.

Repair

To ensure continued operational safety and reliability:

- ▶ Carry out repairs on the device only if they are expressly permitted.
- ▶ Observe federal/national regulations pertaining to the repair of an electrical device.
- ▶ Use original spare parts and accessories from Endress+Hauser only.

Temperature

NOTICE

During operation, heat conduction or heat radiation may cause the temperature in the terminal head to rise.

- ▶ Exceeding the operating temperature of the transmitter or housing is not permitted and must be prevented using appropriate heat insulation or a suitably long extension neck.

NOTICE

Taking convection and heat radiation into account also, the thermometer may become damaged even during installation if the permitted operating temperature is not observed.

- ▶ The maximum/minimum permitted temperature is based on various parameters: maximum/minimum temperatures are specified for thermowell materials, sensor versions, approvals, etc. in the technical documentation. The resulting limit values for the thermometer are based on the respective maximum/minimum permitted values of the individual components.

2.5 Product safety

This measuring device is designed in accordance with good engineering practice to meet state-of-the-art safety requirements, has been tested, and left the factory in a condition in which it is safe to operate.

It meets general safety standards and legal requirements. It also complies with the EU directives listed in the device-specific EU Declaration of Conformity. The manufacturer confirms this by affixing the CE mark.

3 Incoming acceptance and product identification

3.1 Incoming acceptance

Proceed as follows on receipt of the device:

1. Check whether the packaging is intact.
2. If damage is discovered:
Report all damage immediately to the manufacturer.
3. Do not install damaged material, as the manufacturer cannot otherwise guarantee compliance with the safety requirements and cannot be held responsible for the consequences that may result.
4. Compare the scope of delivery against the contents of your order.
5. Remove all the packaging material used for transportation.

3.2 Product identification

The following options are available for identification of the measuring device:

- The device label
- Order code with breakdown of the device features on the delivery note
- Enter the serial number on the device label in *W@M Device Viewer* (www.endress.com/deviceviewer): all the information about the measuring device is displayed.
- Enter the serial number on the device label into the *Endress+Hauser Operations App* or scan the 2-D matrix code (QR code) on the measuring device with the *Endress+Hauser Operations App*: all the information about the measuring device is displayed.

3.2.1 Nameplate

Nameplate data: The nameplate shown below helps you to identify specific product information, such as serial number, design, variables, configuration and device approvals:

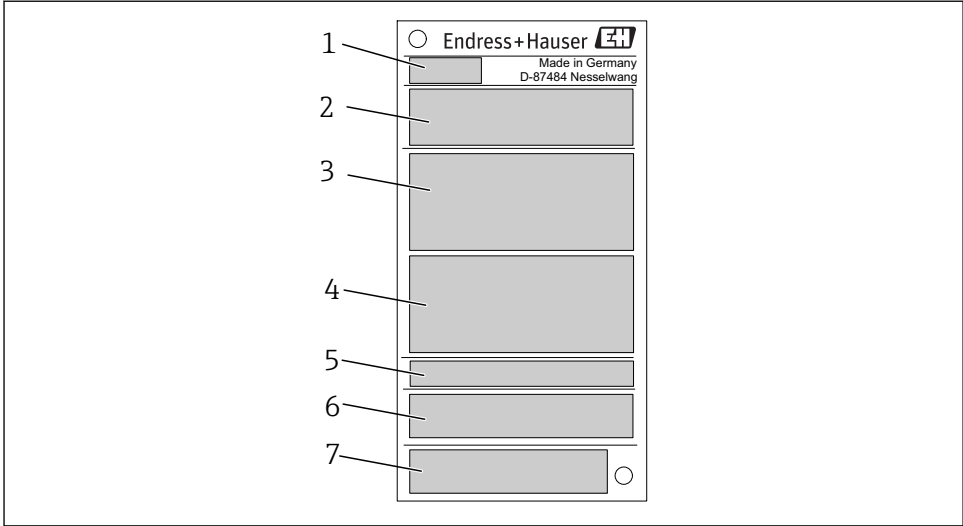

A0038995

1 Nameplate (example)

Field no.	Description	Examples
1	Product root, device designation	TM131, TM111
2	Order code, serial number	-
3	Technical values	Ambient temperature, degree of protection
4	Hazardous area classification and Ex logo	-
5	Device tag	-
6	Proof of functional safety	-
7	Approvals with symbols	CE mark, EAC

i Check the data on the nameplate of the device, and compare them against the requirements of the measuring point.

3.2.2 Name and address of manufacturer

Name of manufacturer:	Endress+Hauser Wetzer GmbH + Co. KG
Address of manufacturer:	Obere Wank 1, D-87484 Nesselwang oder www.endress.com

3.3 Storage and transport



Do not remove the packaging until just before installation.



Thermometers for hygienic applications are sometimes specially cleaned and packed. When opening the packaging, the user must take care to avoid contaminating the device.

Permitted storage temperature:

- Devices without transmitter installed: -40 to $+80$ °C (-40 to $+176$ °F)
- Devices with transmitter installed: see Operating Instructions for respective transmitter

Avoid the following influencing factors:

- Direct sunlight or proximity to hot objects
- Mechanical loads (shocks, pressure, etc.)
- Contamination, steam, dust and corrosive gases
- Hazardous environment
- Humidity

4 Installation

4.1 Installation conditions

Depending on the process connection selected, thermometers can be installed in three positions in pipes or storage tanks. There are no restrictions with regard to orientation. Self-draining in the process must be guaranteed. If there is an opening to detect leaks at the process connection, this opening must be at the lowest possible point.

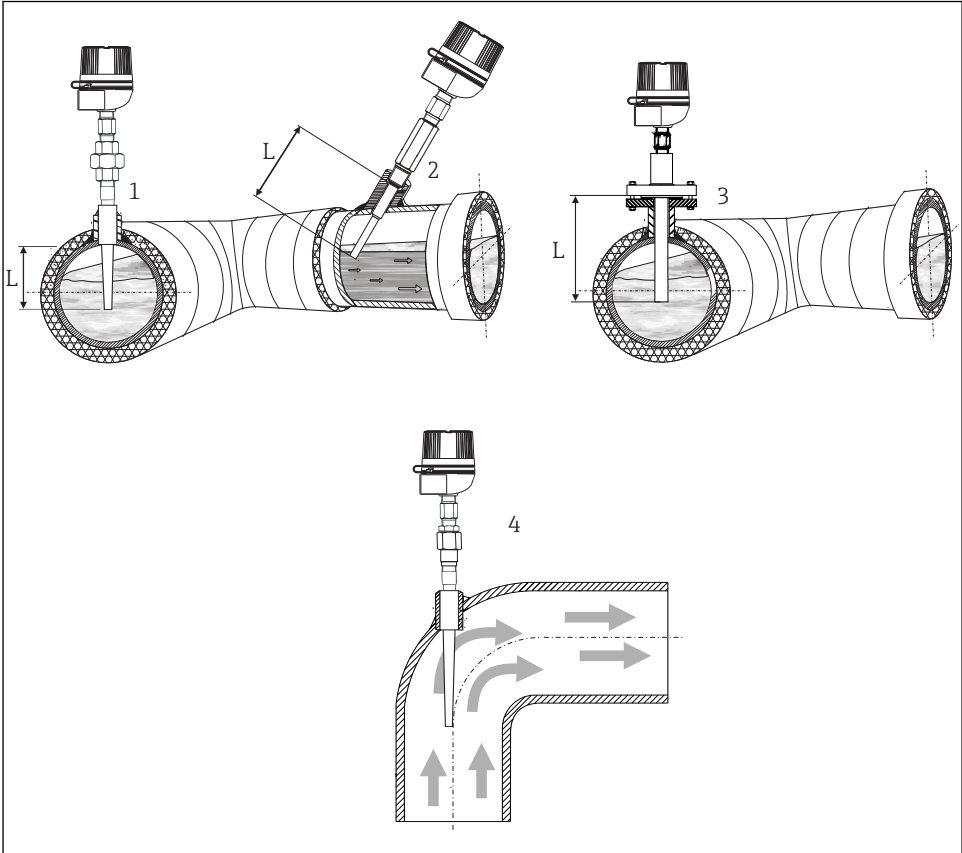

A0037331

2 Installation examples

- 1 General orientation. In pipes with a small cross-section, the sensor tip should reach or extend slightly past the center axis of the pipe ($= L$).
- 2 Slanted orientation
- 3 Straight orientation
- 4 Orientation in pipe elbow

The immersion length of the thermometer can influence the accuracy. If the immersion length is too small then errors in the measurement are caused by heat conduction via the process connection and the container wall. If installing in a pipe, the immersion length should ideally correspond to half of the pipe diameter. Another possibility is to install the thermometer at an angle (see 2 and 4). When determining the immersion length, all the parameters of the thermometer and of the process to be measured must be taken into account (e.g. flow velocity, process pressure).

- Installation possibilities: Pipes, tanks or other plant components
- Recommended minimum immersion depth: 80 to 100 mm (3.15 to 3.94 in)
The immersion length should be at least eight times the thermowell diameter. Example: thermowell diameter 12 mm (0.47 in) x 8 = 96 mm (3.8 in).
- ATEX certification: Observe the installation instructions in the Ex documentation!



When using the measuring device in a hazardous area, the relevant national standards and regulations as well as the safety instructions or installation regulations must be observed.



Other types of installation are possible. Endress+Hauser will advise on the correct design of the measuring point.

4.2 Installing the thermometer



Prior to installation, the device must be checked for any damage that may have occurred in transit. Obvious damage must be reported immediately. It should be noted whether the thermometer may be installed directly in the process or whether a thermowell must be used.



See Technical Information of the relevant thermometer. → 21

To install, proceed as follows:

- The permitted loading capacity of the process connections can be found in the relevant standards.
- The process connection and compression fitting must comply with the maximum specified process pressure.
- Make sure that the device is installed and secured before applying the process pressure.
- Adjust the loading capacity of the thermowell in accordance with the process conditions. It may be necessary to calculate the static and dynamic loading capacity.



It is possible to verify the mechanical loading capacity as a function of the installation and process conditions using the online TW Sizing Module for thermowells in the Endress+Hauser Applicator software. See 'Accessories' section. → 18

Cylindrical threads

Seals must be used for cylindrical threads. In the case of combined thermometer and thermowell assemblies, these seals are already installed (if ordered). It is the responsibility of the system operator to verify the suitability of this seal with regard to the operating conditions, and to replace it with a suitable seal. The seals must be replaced following disassembly. All threads must be firmly tightened using the appropriate torques.

Tapered threads

The operator must verify if additional sealing by means of PTFE tape, hemp or an additional welded seam, for example, is necessary in the case of NPT threads or other tapered threads.

Flange

When using flange connections, the flange of the thermowell must match the counterflange on the process side. The seals used must be suitable for the process and for the flange geometries. The appropriate torques must be used for installation.

Weld-in thermowells

Weld-in thermowells can be welded directly into the pipe or vessel wall, or secured using a welding socket. The specifications on the relevant material data sheets and the applicable guidelines and standards regarding welding procedures, heat treatment, welding fillers, etc. must be observed.

CAUTION

Incorrectly designed, faulty or leaking welded seams can lead to uncontrolled discharge of the process medium.

- ▶ Welding activities must be performed by qualified technical personnel only.
- ▶ When designing the welded seam, the requirements arising from the process conditions must be taken into account.

Installation instructions for electrical thermometers with ceramic thermowell

NOTICE

Ceramic thermowell materials are usually only partially resistant to rapid changes in temperature. A temperature shock may lead to stress cracks in the thermowell.

- ▶ Higher process temperatures require a lower insertion speed. Thermocouples with ceramic thermowells must be pre-heated prior to installation in the hot process, and immersed slowly.
- ▶ Ceramic thermowells must be protected against mechanical loads.
- ▶ When installed horizontally, mechanical shocks or bending stress caused by the weight of the thermowell itself must be avoided.
- ▶ Depending on the material, diameter, length and design, an additional support must be provided when installed horizontally.

 In theory, problems with bending stress apply to metallic thermowells too. Vertical installation is generally preferable.

4.3 Ensuring the degree of protection

The device meets all of the requirements in accordance with the degree of protection indicated on the nameplate. To ensure that the degree of protection of the housing is maintained

following installation in the field or after servicing, compliance with the following points is mandatory:

- The housing seals must be clean and undamaged when inserted into their grooves. The seals must be dried, cleaned or replaced if necessary.
- All housing screws and screw caps must be firmly tightened.
- The cables used for connection must be of the specified outside diameter (e.g. M20x1.5, cable diameter 8 to 12 mm).
- Firmly tighten the cable gland, and use it only in the specified clamping area (the cable diameter must be appropriate to the cable gland).
- The cables must loop down before they enter the cable gland ("water trap"). This means that any moisture that may form cannot enter the gland. The device must be installed so that the cable glands are not facing upwards.
- Do not twist the cables, and use only round cables.
- Replace unused cable glands with a dummy plug (included in the scope of delivery).
- Do not remove the grommet from the cable gland.
- Repeated opening/closing of the device is possible but has a negative impact on the degree of protection.

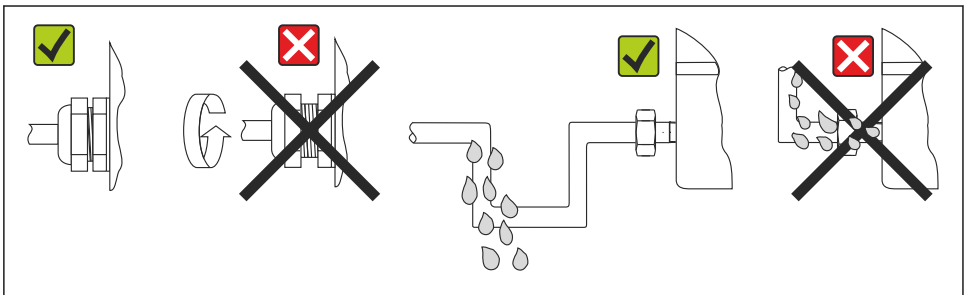

A0024523

3 Connection tips to retain IP67 protection

5 Electrical connection

NOTICE

Risk of short-circuit - may cause the device to malfunction.

- ▶ Check for damage to cables, wires and connection points.

Terminal assignment

⚠ WARNING

Risk of injury from the uncontrolled activation of processes!

- ▶ The supply voltage must be switched off before connecting the device.
- ▶ Make sure that downstream processes are not started unintentionally.

⚠ WARNING

There is a risk of explosion if the supply voltage is connected!

- ▶ The supply voltage must be switched off before connecting the device.

⚠ WARNING

Electrical safety is compromised by an incorrect connection!

- ▶ When using the measuring device in hazardous areas, installation must comply with the corresponding national standards and regulations and the Safety Instructions or Installation or Control Drawings.
- ▶ All data relating to explosion protection is contained in the separate Ex documentation. The Ex documentation is supplied as standard with all Ex-systems .

i Pay attention to the Technical Information when connecting the transmitter electrically!

5.1 Wiring diagram for RTD

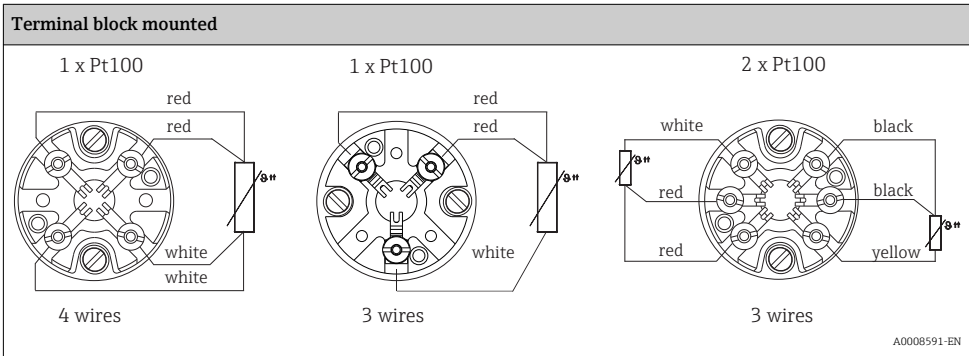

5.2 Wiring diagram for TC

Thermocouple wire colors

As per IEC 60584	As per ASTM E230
<ul style="list-style-type: none"> ▪ Type J: black (+), white (-) ▪ Type K: green (+), white (-) ▪ Type N: red (+), white (-) 	<ul style="list-style-type: none"> ▪ Type J: white (+), red (-) ▪ Type K: yellow (+), red (-) ▪ Type N: orange (+), white (-)

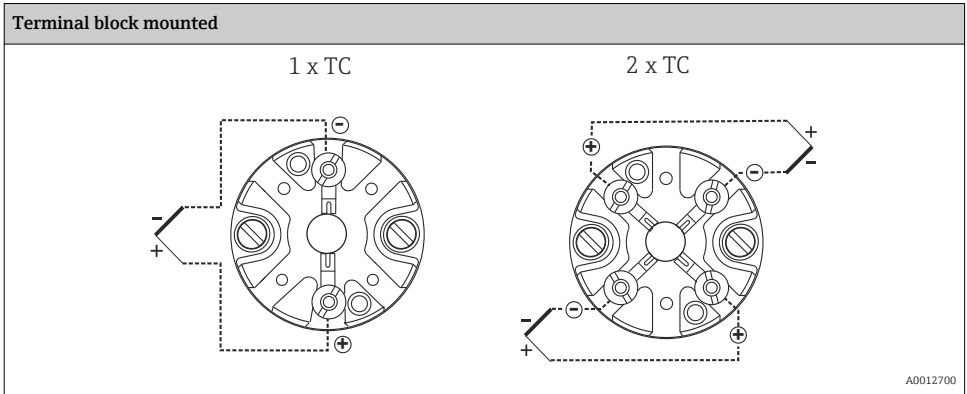

6 Maintenance

No special maintenance work is required for the device.

6.1 Cleaning

A clean, dry cloth can be used to clean the device.

6.2 Endress+Hauser services

Service	Description
Calibration	RTD inserts may drift depending on the application. Regular recalibration to verify accuracy is recommended. The calibration can be performed by E+H or by qualified technical staff using calibration devices onsite.

7 Repair

7.1 Spare parts

i Information on accessories and spare parts that are currently available for the product can be found online at: www.endress.com/spareparts_consumables → **access to specific device information** → enter serial number.

Spare parts for the modular thermometer are:

- Terminal heads
- Temperature transmitter
- Temperature inserts
- Thermowells

8 Accessories

Various accessories, which can be ordered with the device or subsequently from Endress+Hauser, are available for the device. Detailed information on the order code in question is available from your local Endress+Hauser sales center or on the product page of the Endress+Hauser website: www.endress.com.

8.1 Service-specific accessories

Accessories	Description
Applicator	<p>Software for selecting and sizing Endress+Hauser measuring devices:</p> <ul style="list-style-type: none"> ▪ Calculation of all the necessary data for identifying the optimum measuring device: e.g. pressure loss, accuracy or process connections. ▪ Graphic illustration of the calculation results <p>Administration, documentation and access to all project-related data and parameters over the entire life cycle of a project.</p> <p>Applicator is available: Via the Internet: https://portal.endress.com/webapp/applicator</p>
Configurator	<p>Product Configurator - the tool for individual product configuration</p> <ul style="list-style-type: none"> ▪ Up-to-the-minute configuration data ▪ Depending on the device: Direct input of measuring point-specific information such as measuring range or operating language ▪ Automatic verification of exclusion criteria ▪ Automatic creation of the order code and its breakdown in PDF or Excel output format ▪ Ability to order directly in the Endress+Hauser Online Shop <p>The Configurator is available on the Endress+Hauser website: www.endress.com -> Click "Corporate" -> Select country -> Click "Products" -> Select the product using the filters and search field -> Open product page -> The "Configure" button to the right of the product image opens the Product Configurator.</p>
W@M	<p>Life cycle management for your plant</p> <p>W@M supports with a wide range of software applications over the entire process: from planning and procurement, to the installation, commissioning and operation of the measuring devices. All the relevant device information, such as the device status, spare parts and device-specific documentation, is available for every device over the entire life cycle.</p> <p>The application already contains the data of your Endress+Hauser device. Endress+Hauser also takes care of maintaining and updating the data records.</p> <p>W@M is available: Via the Internet: www.endress.com/lifecyclemanagement</p>

9 Technical data

9.1 Output

9.1.1 Output signal



See Technical Information for the mounted transmitter. →  21

9.2 Power supply

9.2.1 Supply voltage



See Technical Information for the mounted transmitter. → 21

9.2.2 Current consumption



See Technical Information for the mounted transmitter. → 21

9.3 Environment

9.3.1 Ambient temperature range

Terminal head	Temperature in °C (°F)
Without mounted head transmitter	Depends on the terminal head used and the cable gland or fieldbus connector See the Technical Information of the relevant thermometer, "Terminal heads" section. → 21
With mounted head transmitter	-40 to 85 °C (-40 to 185 °F)
With mounted head transmitter and display	-20 to 70 °C (-4 to 158 °F)

Extension neck	Temperature in °C (°F)
iTHERM QuickNeck quick-release fastener	-50 to +140 °C (-58 to +284 °F)

9.3.2 Storage temperature

-40 to +80 °C (-40 to +176 °F)

9.3.3 Altitude

Up to 2 000 m (6 561 ft) above mean seal level in accordance with IEC 61010-1

9.3.4 Climate class



See Technical Information for the mounted transmitter. → 21

9.3.5 Degree of protection

max. IP68, type 4X, depending on the design (terminal head, connector, etc.)

9.3.6 Shock- and vibration-resistance



See Technical Information of the relevant thermometer. → 21

9.3.7 Electromagnetic compatibility (EMC)

EMC to all relevant requirements of the IEC/EN 61326-series and NAMUR Recommendation EMC (NE21). For details, refer to the Declaration of Conformity.

Maximum fluctuations during EMC-tests: < 1 % of measuring span.



Interference immunity to IEC/EN 61326-series, requirements for industrial areas

Interference emission to IEC/EN 61326-series, electrical equipment Class B

9.3.8 Process temperature range

The maximum possible process pressure depends on various influencing factors, such as the design, process connection and process temperature. Maximum possible process pressures for the individual process connections.

 See Technical Information for the relevant thermometer, "Process connection" section. →  21

 It is possible to verify the mechanical loading capacity as a function of the installation and process conditions using the online TW Sizing Module for thermowells in the Endress+Hauser Applicator software. See "Accessories" section. →  18

Example of the dependency of the permitted flow velocity on the immersion length and process medium

The maximum flow velocity tolerated by the thermometer diminishes with increasing immersion of the insert in the flow of the medium being measured. The flow velocity is also dependent on the diameter of the thermometer tip, the type of medium being measured, the process temperature and the process pressure. The following diagrams exemplify the maximum permitted flow velocities in water and superheated steam at a process pressure of 40 bar (580 PSI).

9.3.9 Electrical safety

- Protection class III
- Overvoltage category II
- Pollution level 2

9.4 Certificates and approvals

9.4.1 CE mark

The product meets the requirements of the harmonized European standards. As such, it complies with the legal specifications of the EC directives. The manufacturer confirms successful testing of the product by affixing to it the CE-mark.

9.4.2 EAC mark

The product meets the legal requirements of the EEU guidelines. The manufacturer confirms the successful testing of the product by affixing the EAC mark.

9.4.3 Ex approvals

For further details on the available Ex versions (ATEX, IECEx, CSA, etc.), please contact your Endress+Hauser sales organization. All relevant data for hazardous areas can be found in separate Ex documentation. If required, please request copies.

9.4.4 Marine approval

Information on the "Type Approval Certificates" currently available (DNVGL, BV, etc.) can be obtained from the sales organization.

9.4.5 Electrical safety

- IEC/EN 61010-1
- CAN/CSA-C22.2 no. 61010-1
- UL 61010-1

9.5 Supplementary documentation

Technical Information

- **iTEMP temperature head transmitter:**
 - TMT71, PC-programmable, single-channel, RTD and TC, Ω, mV (TI01393T/09)
 - HART® TMT72, PC-programmable, single-channel, RTD, TC, Ω, mV (TI01392T/09)
 - TMT180, PC-programmable, single-channel, Pt100 (TI088R/09)
 - HART® TMT82, two-channel, RTD, TC, Ω, mV (TI01010T/09)
 - PROFIBUS® PA TMT84, two-channel, RTD, TC, Ω, mV (TI138R/09)
 - HART®, FOUNDATION Fieldbus™, PROFIBUS® TMT162, two-channel, RTD, TC, Ω, mV (TI00086R/09)
- **iTHERM thermometer:**
 - iTHERM TM131 (TI01373T/09)
 - iTHERM TM101 (TI01446T/09)
 - iTHERM TM111 (TI01445T/09)
 - iTHERM TM121 (TI01455T/09)
- **Thermowell:**
 - Welded thermowell iTHERM TT131 (TI01442T/09)
- **Insert:**
 - iTHERM TS111 (TI01014T/09)
- **Supplementary documentation ATEX/IECEx:**
 - ATEX: II1G Ex ia IIC T6...T4 Ga: XA01736T/09



71410963

www.addresses.endress.com
