

# Operating Instructions

## Memosens CLS21E

Conductivity sensor with Memosens protocol  
For contacting conductivity measurement in liquids







# Table of contents









<b>1</b>	<b>About this document</b>	<b>3</b>	10.3 Environment	17
1.1	Safety information	3	10.4 Process	17
1.2	Symbols	3	10.5 Mechanical construction	18
1.3	Documentation	3		
<b>2</b>	<b>Basic safety instructions</b>	<b>4</b>	<b>Index</b>	<b>19</b>
2.1	Requirements of the personnel	4		
2.2	Intended use	4		
2.3	Workplace safety	4		
2.4	Operational safety	4		
2.5	Product safety	5		
<b>3</b>	<b>Incoming acceptance and product identification</b>	<b>5</b>		
3.1	Incoming acceptance	5		
3.2	Product identification	5		
3.3	Scope of delivery	6		
<b>4</b>	<b>Mounting</b>	<b>7</b>		
4.1	Mounting requirements	7		
4.2	Mounting the sensor	9		
4.3	Post-mounting check	9		
<b>5</b>	<b>Electrical connection</b>	<b>9</b>		
5.1	Connecting the sensor	10		
5.2	Ensuring the degree of protection	10		
5.3	Post-connection check	10		
<b>6</b>	<b>Commissioning</b>	<b>11</b>		
<b>7</b>	<b>Maintenance</b>	<b>12</b>		
<b>8</b>	<b>Repair</b>	<b>13</b>		
8.1	General information	13		
8.2	Spare parts	13		
8.3	Return	13		
8.4	Disposal	13		
<b>9</b>	<b>Accessories</b>	<b>14</b>		
9.1	Assemblies	14		
9.2	Measuring cables	15		
9.3	Calibration solutions	16		
<b>10</b>	<b>Technical data</b>	<b>16</b>		
10.1	Input	16		
10.2	Performance characteristics	16		

# 1 About this document

## 1.1 Safety information

Structure of information	Meaning
<p> <b>DANGER</b></p> <p><b>Causes (/consequences)</b> If necessary, Consequences of non-compliance (if applicable)</p> <ul style="list-style-type: none"> <li>▶ Corrective action</li> </ul>	<p>This symbol alerts you to a dangerous situation. Failure to avoid the dangerous situation <b>will</b> result in a fatal or serious injury.</p>
<p> <b>WARNING</b></p> <p><b>Causes (/consequences)</b> If necessary, Consequences of non-compliance (if applicable)</p> <ul style="list-style-type: none"> <li>▶ Corrective action</li> </ul>	<p>This symbol alerts you to a dangerous situation. Failure to avoid the dangerous situation <b>can</b> result in a fatal or serious injury.</p>
<p> <b>CAUTION</b></p> <p><b>Causes (/consequences)</b> If necessary, Consequences of non-compliance (if applicable)</p> <ul style="list-style-type: none"> <li>▶ Corrective action</li> </ul>	<p>This symbol alerts you to a dangerous situation. Failure to avoid this situation can result in minor or more serious injuries.</p>
<p> <b>NOTICE</b></p> <p><b>Cause/situation</b> If necessary, Consequences of non-compliance (if applicable)</p> <ul style="list-style-type: none"> <li>▶ Action/note</li> </ul>	<p>This symbol alerts you to situations which may result in damage to property.</p>

## 1.2 Symbols

-  Additional information, tips
-  Permitted
-  Recommended
-  Forbidden or not recommended
-  Reference to device documentation
-  Reference to page
-  Reference to graphic
-  Result of a step

## 1.3 Documentation



Technical Information Memosens CLS2 1E, TI01528C

In addition to these Operating Instructions, an XA with "Safety instructions for electrical apparatus in the hazardous area" is also included with sensors for use in the hazardous area.

- ▶ Please follow instructions on use in the hazardous area carefully.

## 2 Basic safety instructions

### 2.1 Requirements of the personnel

- Installation, commissioning, operation and maintenance of the measuring system may be carried out only by specially trained technical personnel.
- The technical personnel must be authorized by the plant operator to carry out the specified activities.
- The electrical connection may be performed only by an electrical technician.
- The technical personnel must have read and understood these Operating Instructions and must follow the instructions contained therein.
- Faults at the measuring point may only be rectified by authorized and specially trained personnel.

 Repairs not described in the Operating Instructions provided must be carried out only directly at the manufacturer's site or by the service organization.

### 2.2 Intended use

The conductivity sensor is designed for the conductive measurement of the conductivity of liquids.

It is used in the following areas:

Measurements in media with medium or high conductivity

Use of the device for any purpose other than that described, poses a threat to the safety of people and of the entire measuring system and is therefore not permitted.

The manufacturer is not liable for damage caused by improper or non-designated use.

### 2.3 Workplace safety

As the user, you are responsible for complying with the following safety conditions:

- Installation guidelines
- Local standards and regulations
- Regulations for explosion protection

#### **Electromagnetic compatibility**

- The product has been tested for electromagnetic compatibility in accordance with the applicable international standards for industrial applications.
- The electromagnetic compatibility indicated applies only to a product that has been connected in accordance with these Operating Instructions.

### 2.4 Operational safety

**Before commissioning the entire measuring point:**

1. Verify that all connections are correct.
2. Ensure that electrical cables and hose connections are undamaged.
3. Do not operate damaged products, and protect them against unintentional operation.
4. Label damaged products as defective.

**During operation:**

- ▶ If faults cannot be rectified:  
products must be taken out of service and protected against unintentional operation.

## 2.5 Product safety

The product is designed to meet state-of-the-art safety requirements, has been tested, and left the factory in a condition in which it is safe to operate. The relevant regulations and international standards have been observed.

# 3 Incoming acceptance and product identification

## 3.1 Incoming acceptance

1. Verify that the packaging is undamaged.
  - ↳ Notify the supplier of any damage to the packaging.  
Keep the damaged packaging until the issue has been resolved.
2. Verify that the contents are undamaged.
  - ↳ Notify the supplier of any damage to the delivery contents.  
Keep the damaged goods until the issue has been resolved.
3. Check that the delivery is complete and nothing is missing.
  - ↳ Compare the shipping documents with your order.
4. Pack the product for storage and transportation in such a way that it is protected against impact and moisture.
  - ↳ The original packaging offers the best protection.  
Make sure to comply with the permitted ambient conditions.

If you have any questions, please contact your supplier or your local Sales Center.

## 3.2 Product identification

### 3.2.1 Nameplate

The nameplate provides you with the following information on your device:

- Manufacturer identification
  - Extended order code
  - Serial number
  - Safety information and warnings
- ▶ Compare the information on the nameplate with the order.

### 3.2.2 Product identification

#### Product page

[www.endress.com/cls21e](http://www.endress.com/cls21e)

#### Interpreting the order code

The order code and serial number of your product can be found in the following locations:

- On the nameplate
- In the delivery papers

#### Obtaining information on the product

1. Go to [www.endress.com](http://www.endress.com).
2. Page search (magnifying glass symbol): Enter valid serial number.
3. Search (magnifying glass).
  - ↳ The product structure is displayed in a popup window.
4. Click the product overview.
  - ↳ A new window opens. Here you fill information pertaining to your device, including the product documentation.

#### Manufacturer's address

Endress+Hauser Conducta GmbH+Co. KG  
Dieselstraße 24  
D-70839 Gerlingen

### 3.3 Scope of delivery

The scope of delivery includes:

- Sensor in the version ordered
- Operating Instructions

## 4 Mounting

### 4.1 Mounting requirements

The sensors are installed directly via the process connection. As an option, the sensor can also be installed via a flow or immersion assembly.

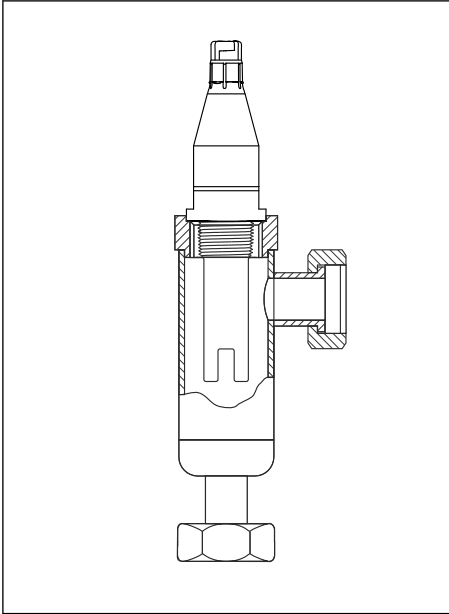

A0019019

1 Installation in flow assembly CLA751

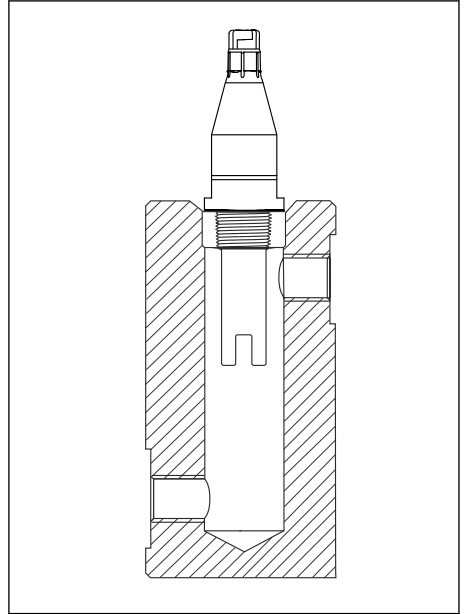

A0035650

2 Installation in flow assembly CLA752

For the installation of sensors with a G1 thread in vessels: immersion assembly Dipfit CLA111 .

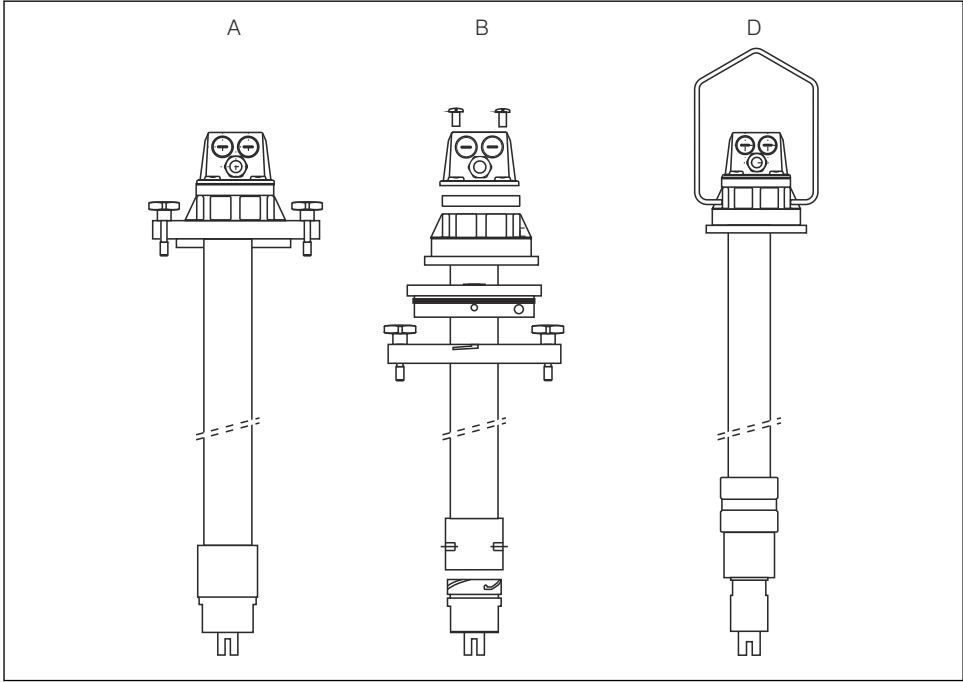

A0024145

3 Installation in immersion assembly, mounting versions A, B and D



## 4.2 Mounting the sensor

1.

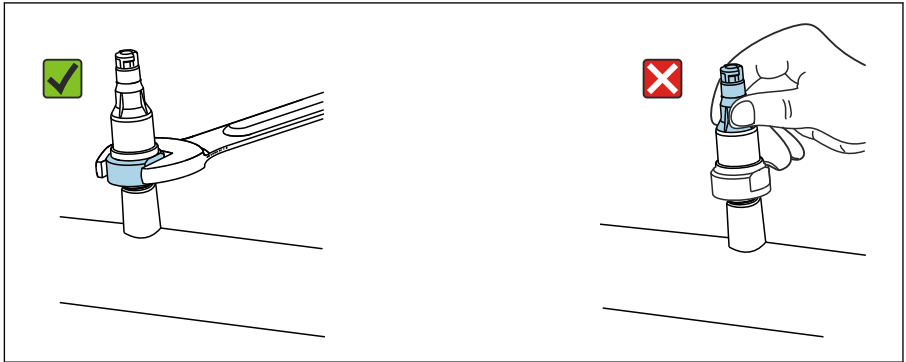

A0042909

### NOTICE

#### Incorrect mounting or disassembly

The head could become loose and fall off, resulting in total sensor failure!

- ▶ Only mount the sensor via the process connection.
- ▶ To do so, use a suitable tool, such as an open-ended wrench.

Install the sensor via the process connection or an assembly.

2. Ensure that the electrodes are fully immersed in the medium during measurement. Immersion depth: at least 35 mm (1.38").

## 4.3 Post-mounting check

1. Are the sensor and cable undamaged?
2. Is the sensor installed in the process connection and is not suspended from the cable?

## 5 Electrical connection

### ⚠ WARNING

#### Device is live!

Incorrect connection may result in injury or death!

- ▶ The electrical connection may be performed only by an electrical technician.
- ▶ The electrical technician must have read and understood these Operating Instructions and must follow the instructions contained therein.
- ▶ **Prior** to commencing connection work, ensure that no voltage is present on any cable.

## 5.1 Connecting the sensor

The electrical connection of the sensor to the transmitter is established using the measuring cable CYK10.

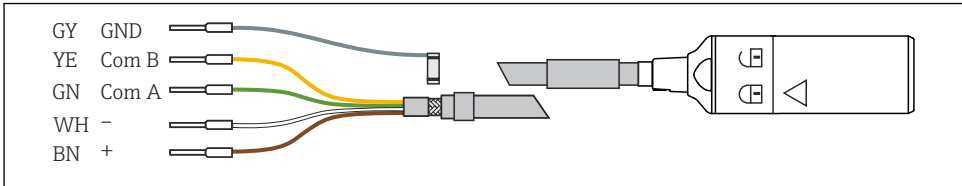

A0024019

4 Measuring cable CYK10

### NOTICE

#### Mechanical twist protection

If too much force is applied to the Memosens head, this can shear the connections and therefore destroy the sensor!

- ▶ There is no need to exert excessive force when connecting the sensor to the cable coupling. Proceed with care!
- ▶ If the Memosens coupling clearly will not close, check the coupling for dirt or mechanical damage, and make sure that you are turning it in the right direction. Pay attention to the lock symbol on the coupling!
- ▶ If necessary, use a different Memosens cable.

## 5.2 Ensuring the degree of protection

Only the mechanical and electrical connections which are described in these instructions and which are necessary for the required, designated use, may be carried out on the device delivered.

- ▶ Exercise care when carrying out the work.

Otherwise, the individual types of protection (Ingress Protection (IP), electrical safety, EMC interference immunity) agreed for this product can no longer be guaranteed due, for example to covers being left off or cable (ends) that are loose or insufficiently secured.

## 5.3 Post-connection check

### ⚠ WARNING

#### Connection errors

The safety of people and of the measuring point is at risk! The manufacturer does not accept any responsibility for errors that result from failure to comply with the instructions in this manual.

- ▶ Put the measuring point into operation only if you can answer **yes** to **all** the following questions.

Product status and specifications

- ▶ Are the sensor and cable free from damage on the outside?

### Electrical connection

- ▶ Is the installed cable strain-relieved and not twisted?
- ▶ Is a sufficient length of the cable cores stripped, and are the cores correctly positioned in the terminal on the transmitter?
- ▶ Are all plug-in terminals on the transmitter securely engaged?
- ▶ Are all cable entries mounted on the transmitter, tightened and leak-tight?

## 6 Commissioning

Prior to initial commissioning, ensure that:

- The sensor is correctly installed
- The electrical connection is correct

1. Check the temperature compensation and damping settings on the transmitter.



Operating Instructions of the transmitter being used, e.g. BA01245C if using Liquiline CM44x or CM44xR.

### **⚠ WARNING**

#### **Escaping process medium**

Risk of injury from high pressure, high temperatures or chemical hazards!

- ▶ Before applying pressure to an assembly with cleaning system, ensure that the system has been connected correctly.
- ▶ If you cannot reliably establish the correct connection, do not install the assembly in the process.

If using an assembly with automatic cleaning function:

2. Check that the cleaning medium (water or air, for example) is connected correctly.

3. Following commissioning:

Maintain the sensor at regular intervals.

- ↳ This is the only way to ensure reliable measurements.



As the sensor can be operated with a nominal pressure greater than 1 bar (15 psi), it has been registered according to CSA B51 ("Boiler, pressure vessel, and pressure piping code"; category F) with a CRN (Canadian Registration Number) in all Canadian provinces.

The CRN is located on the nameplate.

## 7 Maintenance

### WARNING

#### Thiocarbamide

Harmful if swallowed! Limited evidence of carcinogenicity! Possible risk of harm to the unborn child! Dangerous for the environment with long-term effects!

- ▶ Wear protective goggles, protective gloves and appropriate protective clothing.
- ▶ Avoid all contact with the eyes, mouth and skin.
- ▶ Avoid discharge into the environment.

### CAUTION

#### Corrosive chemicals

Risk of chemical burns to the eyes and skin and risk of damage to clothing and equipment!

- ▶ It is absolutely essential to protect the eyes and hands properly when working with acids, alkalis and organic solvents!
- ▶ Wear protective goggles and safety gloves.
- ▶ Clean away splashes on clothes and other objects to prevent any damage.
- ▶ Comply with instructions in the safety data sheets for the chemicals used.

Clean away fouling on the sensor as follows depending on the type of fouling:

#### 1. Oily and greasy films:

Clean with a grease remover, e.g. alcohol, or hot water and a surfactant-containing (basic) agent (e.g. washing-up liquid).

#### 2. Lime and metal hydroxide buildup and low solubility (lyophobic) organic buildup:

Dissolve buildup with diluted hydrochloric acid (3 %) and then rinse thoroughly with plenty of clear water.

#### 3. Sulfidic buildup (from flue gas desulfurization or wastewater treatment plants):

Use a mixture of hydrochloric acid (3 %) and thiocarbamide (commercially available) and then rinse thoroughly with plenty of clear water.

#### 4. Buildup containing protein (e.g. in the food industry):

Use a mixture of hydrochloric acid (0.5 %) and pepsin (commercially available) and then rinse thoroughly with plenty of clear water.

#### 5. Readily soluble biological buildup:

Rinse with pressurized water.

After cleaning, rinse the sensor thoroughly with plenty of water.

## 8 Repair

### 8.1 General information

The repair and conversion concept provides for the following:

- The product has a modular design
- Spare parts are grouped into kits which include the associated kit instructions
- Only use original spare parts from the manufacturer
- Repairs are carried out by the manufacturer's Service Department or by trained users
- Certified devices can only be converted to other certified device versions by the manufacturer's Service Department or at the factory
- Observe applicable standards, national regulations, Ex documentation (XA) and certificates

1. Carry out the repair according to the kit instructions.
2. Document the repair and conversion and enter, or have entered, in the Life Cycle Management tool (W@M).

### 8.2 Spare parts

Device spare parts that are currently available for delivery can be found on the website:

<https://portal.endress.com/webapp/SparePartFinder>

- ▶ Quote the serial number of the device when ordering spare parts.

### 8.3 Return

The product must be returned if repairs or a factory calibration are required, or if the wrong product was ordered or delivered. As an ISO-certified company and also due to legal regulations, Endress+Hauser is obliged to follow certain procedures when handling any returned products that have been in contact with medium.

To ensure the swift, safe and professional return of the device:

- ▶ Refer to the website [www.endress.com/support/return-material](http://www.endress.com/support/return-material) for information on the procedure and conditions for returning devices.

### 8.4 Disposal



If required by the Directive 2012/19/EU on waste electrical and electronic equipment (WEEE), the product is marked with the depicted symbol in order to minimize the disposal of WEEE as unsorted municipal waste. Do not dispose of products bearing this marking as unsorted municipal waste. Instead, return them to the manufacturer for disposal under the applicable conditions.

## 9 Accessories

The following are the most important accessories available at the time this documentation was issued.

Listed accessories are technically compatible with the product in the instructions.

1. Application-specific restrictions of the product combination are possible. Ensure conformity of the measuring point to the application. This is the responsibility of the operator of the measuring point.
2. Pay attention to the information in the instructions for all products, particularly the technical data.
3. For accessories not listed here, please contact your Service or Sales Center.

### 9.1 Assemblies

#### Dipfit CLA111

- Immersion assembly for open and closed vessels with flange DN 100
- Product Configurator on the product page: [www.products.endress.com/cla111](http://www.products.endress.com/cla111)



Technical Information TI00135C

#### Flow assembly CLA751

- For installing conductivity sensors with G1 thread (CLS12, CLS13, CLS2.1, CLS30)
- Inlet (below) and outlet (lateral) DN 20 with G1 thread adapter nut
- Stainless steel 1.4571 (AISI 316Ti)
- Max. temperature 160 °C (320 °F), max. pressure 12 bar (174 psi)
- Order No. 50004201

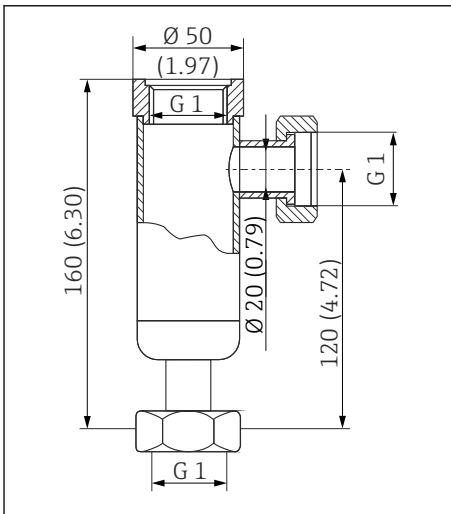

A0024377

5 Dimensions in mm (inch)

**Flow assembly CLA752**

- For installing conductivity sensors with G1 thread (CLS12, CLS13, CLS21, CLS30)
- Inlet (lateral) and outlet (lateral) DN 20 with G½ internal thread
- Polypropylene (PP)
- Max. temperature 90 °C (194 °F), max. pressure 6 bar (87 psi)
- Order No. 50033772

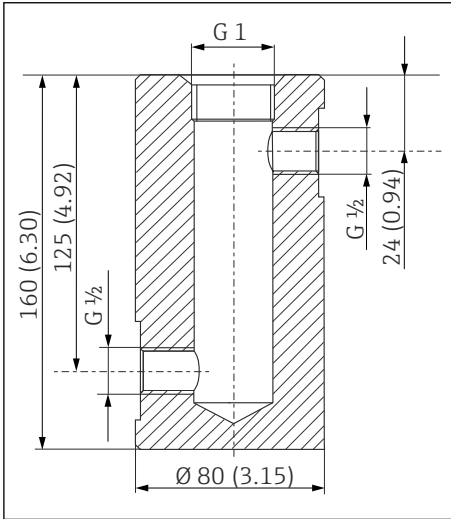

A0024378

6 Dimensions in mm (inch)

**9.2 Measuring cables**

**Memosens data cable CYK10**

- For digital sensors with Memosens technology
- Product Configurator on the product page: [www.endress.com/cyk10](http://www.endress.com/cyk10)

 Technical Information TI00118C

**Memosens data cable CYK11**

- Extension cable for digital sensors with Memosens protocol
- Product Configurator on the product page: [www.endress.com/cyk11](http://www.endress.com/cyk11)

 Technical Information TI00118C

## 9.3 Calibration solutions

### Conductivity calibration solutions CLY11

Precision solutions referenced to SRM (Standard Reference Material) by NIST for qualified calibration of conductivity measuring systems in accordance with ISO 9000

- CLY11-A, 74  $\mu\text{S}/\text{cm}$  (reference temperature 25 °C (77 °F)), 500 ml (16.9 fl.oz)  
Order No. 50081902
- CLY11-B, 149.6  $\mu\text{S}/\text{cm}$  (reference temperature 25 °C (77 °F)), 500 ml (16.9 fl.oz)  
Order No. 50081903
- CLY11-C, 1.406 mS/cm (reference temperature 25 °C (77 °F)), 500 ml (16.9 fl.oz)  
Order No. 50081904
- CLY11-D, 12.64 mS/cm (reference temperature 25 °C (77 °F)), 500 ml (16.9 fl.oz)  
Order No. 50081905



Technical Information TI00162C

## 10 Technical data

### 10.1 Input

#### 10.1.1 Measured variables

- Conductivity
- Temperature

#### 10.1.2 Measuring ranges

**Conductivity**<sup>1)</sup> 10  $\mu\text{S}/\text{cm}$  to 20 mS/cm

1) In relation to water at 25 °C (77 °F)

**Temperature** -20 to 135 °C (-4 to 275 °F)

#### 10.1.3 Cell constant

$k = 1.0 \text{ cm}^{-1}$ , nominal

#### 10.1.4 Temperature compensation

Pt1000 (Class A according to IEC 60751)

## 10.2 Performance characteristics

### 10.2.1 Measurement uncertainty

Each individual sensor is factory-measured in a solution with approx. 5 mS/cm using a reference measuring system traceable to NIST or PTB. The exact cell constant is entered into



the manufacturer certificate supplied. The uncertainty of measurement in determining the cell constant is 1.0 %.

## 10.2.2 Response time

<b>Conductivity</b>	$t_{95} \leq 2 \text{ s}$
<b>Temperature</b> <sup>1)</sup>	$t_{90} \leq 30 \text{ s}$ <sup>2)</sup>

1) DIN VDI/VDE 3522-2 ( 0.3 m/s laminar)

2) With temperature prediction activated as standard

## 10.2.3 Measurement error

<b>Conductivity</b>	$\leq 5 \%$ of reading, in specified measuring range
<b>Temperature</b>	$\leq 2.5 \text{ K}$ , in measuring range $-20$ to $100 \text{ }^\circ\text{C}$ ( $-4$ to $212 \text{ }^\circ\text{F}$ ) $\leq 3.5 \text{ K}$ , in measuring range $100$ to $135 \text{ }^\circ\text{C}$ ( $212$ to $275 \text{ }^\circ\text{F}$ )

## 10.2.4 Repeatability

<b>Conductivity</b>	$\leq 0.2 \%$ of reading, in specified measuring range
<b>Temperature</b>	$\leq 0.05 \text{ K}$

## 10.3 Environment

### 10.3.1 Ambient temperature

$-20$  to  $60 \text{ }^\circ\text{C}$  ( $-4$  to  $140 \text{ }^\circ\text{F}$ )

### 10.3.2 Storage temperature

$-25$  to  $+80 \text{ }^\circ\text{C}$  ( $-10$  to  $+180 \text{ }^\circ\text{F}$ )

### 10.3.3 Degree of protection

IP 68 / NEMA type 6P (1.9 m water column,  $20 \text{ }^\circ\text{C}$ , 24 h)

## 10.4 Process

### 10.4.1 Process temperature

$-20$  to  $135 \text{ }^\circ\text{C}$  ( $-4$  to  $275 \text{ }^\circ\text{F}$ ) at 3.5 bar (50 psi) absolute

### 10.4.2 Process pressure

17 bar (247 psi) absolute, at  $20 \text{ }^\circ\text{C}$  ( $68 \text{ }^\circ\text{F}$ )

### 10.4.3 Temperature/pressure ratings

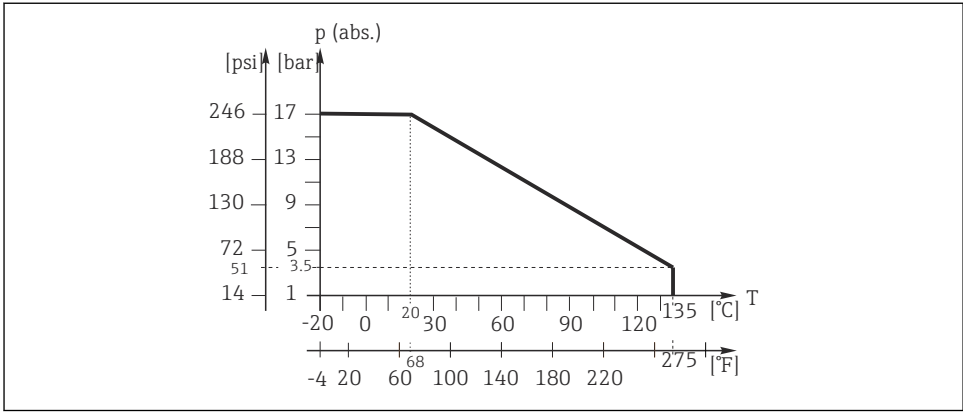

A0044757

7 Mechanical pressure-temperature resistance

## 10.5 Mechanical construction

### 10.5.1 Weight

Approx. 0.3 kg (0.66 lbs) depending on version

### 10.5.2 Materials (in contact with medium)

Electrodes	Graphite
Sensor shaft	Polyethersulfone (PES-GF20)
Thermal conductivity socket for temperature probe	Titanium 3.7035

### 10.5.3 Materials (not in contact with medium)

#### Information according to REACH Regulation (EC) 1907/2006 Art. 33/1)

An internal connector contains the SVHC substance lead (CAS number 7439-92-1) with over 0.1 % (w/w).

The product does not present a hazard if it is used as designated.

### 10.5.4 Process connection

- G1 thread
- NPT 1" thread

# Index

## A

Ambient temperature . . . . . 17

## C

Cell constant . . . . . 16

Check

    Connection . . . . . 10

    Mounting . . . . . 9

Connection

    Check . . . . . 10

    Ensuring the degree of protection . . . . . 10

## D

Degree of protection

    Ensuring . . . . . 10

    Technical data . . . . . 17

Disposal . . . . . 13

Documentation . . . . . 3

## E

Electrical connection . . . . . 9

## I

Incoming acceptance . . . . . 5

Intended use . . . . . 4

## M

Materials . . . . . 18

Measured variables . . . . . 16

Measurement error . . . . . 17

Measurement uncertainty . . . . . 16

Measuring ranges . . . . . 16

Mounting

    Check . . . . . 9

    Sensor . . . . . 9

## N

Nameplate . . . . . 5

## O

Operational safety . . . . . 4

## P

Performance characteristics . . . . . 16

Pressure/temperature ratings . . . . . 18

Process connection . . . . . 18

Process pressure . . . . . 17

Process temperature . . . . . 17

Product identification . . . . . 6

Product safety . . . . . 5

## R

Repair . . . . . 13

Repeatability . . . . . 17

Response time . . . . . 17

Return . . . . . 13

## S

Safety

    Operation . . . . . 4

    Product . . . . . 5

    Workplace safety . . . . . 4

Safety information . . . . . 3

Scope of delivery . . . . . 6

Sensor

    Cleaning . . . . . 12

    Connecting . . . . . 10

    Installing . . . . . 9

Spare parts . . . . . 13

Storage temperature . . . . . 17

Symbols . . . . . 3

## T

Technical data

    Environment . . . . . 17

    Input . . . . . 16

    Mechanical construction . . . . . 18

    Performance characteristics . . . . . 16

    Process . . . . . 17

Temperature compensation . . . . . 16

Temperature/pressure ratings . . . . . 18

## U

Use . . . . . 4

## W

Weight . . . . . 18

Workplace safety . . . . . 4



71610327

[www.addresses.endress.com](http://www.addresses.endress.com)

---