

Common Specifications (applies to all CPF fittings in this datasheet)

DESCRIPTION

CPF[♦] is an improved cone type fitting system that adds a unique o-ring sealing system which permits leak free connections without tools. CPF fittings can be directly connected to 1/4" medium pressure cone type fittings from other manufacturers*, provided that wrenches are used to complete the connection. The fittings of the CPF system have been designed and tested to comply with ASME B31.3-2018, Chapter IX: High Pressure Piping.

♦U.S. Patent No. 8,794,677

*HiP: 1/4" Female and Male Medium Pressure (LF4 & LM4 series)

Autoclave Engineers: 1/4" Female and Male Medium Pressure (SF250CX series)

PERFORMANCE

Maximum Allowable Working Pressure (MAWP): **10 000 psi / 700 bar / 70 MPa**
 Finger-tight: **-20 to 50°C**
 Wrench-tight: **-40 to 150°C**
 Minimum Hose Bend Radius: **1.0" (25mm)**

Most fittings throughout this document meet the MAWP specification of 10 000 psi / 700 bar / 70 MPa. Exceptions are labeled with an icon (5 or 15) and a key to indicate the pressure rating.

Non-Crystal MP adapters require wrench tightening.

CONSTRUCTION

Thread Type: **7/16-20 UNF 2B**
 Cone Angle: **60°, nominal**
 Fittings: **High Strength 316 Stainless Steel** *Hose is not compatible with dioctyl sebacate fluid.*
 Hose: **Polyamide core with urethane jacket**

External Hose Diameter: **0.235" (6 mm)**
 Internal Hose Diameter: **0.08" (2 mm)**
 Hose Weight: **0.0179 lbs/ft (26.6 g/m)**
 CPF Female O-rings: **AS568A-012, Viton® 80 or 90 #3981**
 O-ring Lubricant: **Molykote® 55**

CAUTION: To achieve CPF maximum allowable working pressures no o-ring substitutions are allowed.

RECOMMENDATIONS

Thread Lubricant: **Use a process compatible fluid** *If a torque wrench isn't practical to use, hand tighten then tighten an additional 20 degrees using a wrench.*
 Wrench Torque: **100–140 in-lbs (11.3–15.8Nm)**



Quick Links Click a Category to Navigate to its Page

CPF Fittings	2	M20 Fittings	10
NPT Fittings	5	Transmitter Fittings	11
NPT Fitting Kits	7	Tube Fitting	11
BSP Fittings	8	AN4 Fittings	12
BSP Fitting Kits	9	Non-Crystal MP Adapters	13

Note Regarding CPF Hose (MPH-X)

Due to the wide variety of operating conditions it may be subject to, Crystal Engineering, as well as Distributors and Representatives of Crystal products, do not warrant that this hose is suitable for any specific use. This hose is not for use with compressed natural gas (CNG).

When used with gases, fuels (liquid or gas) and refrigerants, permeation (i.e., seepage) will occur from inside the hose. In enclosed or unventilated spaces this permeation may result in high concentrations of vapors which are potentially flammable, explosive or toxic.

Care must be taken to protect hoses from snagging, kinking, bending smaller than the minimum bend radius, and cutting. Any hose that has been damaged in any way should be removed from service and discarded immediately.

Autoclave Engineers Fluid Components is a division of Snap-tite, Inc.

HiP is High Pressure Equipment Company.

Molykote is a registered trademark of Dow Corning Corporation.

Viton is a registered trademark of DuPont Performance Elastomers.

Swagelok is a registered trademark of Swagelok Company.

CPF Fittings

HOSES (10 000 psi)

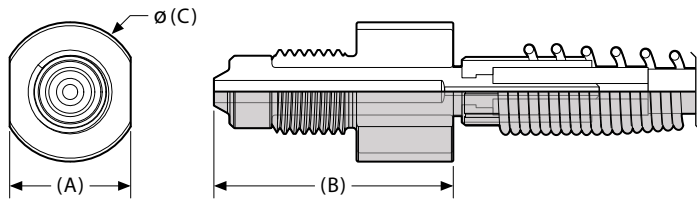

(A)	(B)	(C)
0.63" (16 mm)	1.29" (33 mm)	0.72" (18 mm)

Length	Part Number
50 cm	MPH-50CM
1 m	MPH-1
1.5 m	MPH-1.5
2 m	MPH-2
3 m	MPH-3
5 m	MPH-5
10 m	MPH-10
25 m	MPH-25
50 m	MPH-50
100 m	MPH-100

MALE CONNECTOR

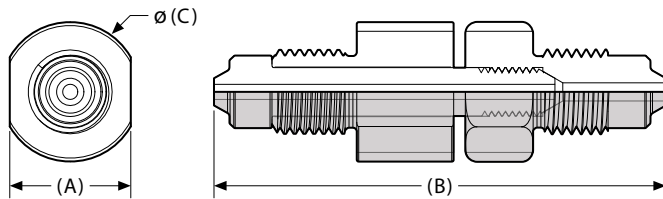

(A)	(B)	(C)	Part Number
0.63" (16 mm)	2.33" (59 mm)	0.72" (18 mm)	MPM-MPM

CPF Fittings

UNION

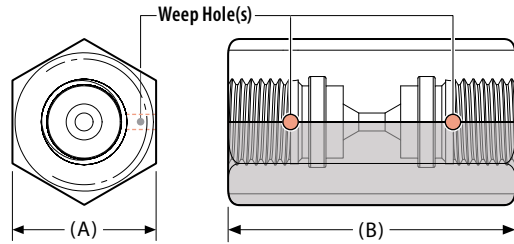

(A)	(B)	Part Number
0.75" (19 mm)	1.50" (38 mm)	MPF-MPF

UNION TEE

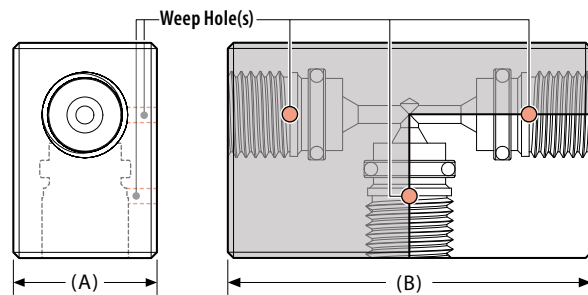

(A)	(B)	Part Number
0.75" (19 mm)	1.90" (48 mm)	MPF-MPFTU

CPF Fittings

BULKHEAD MOUNT

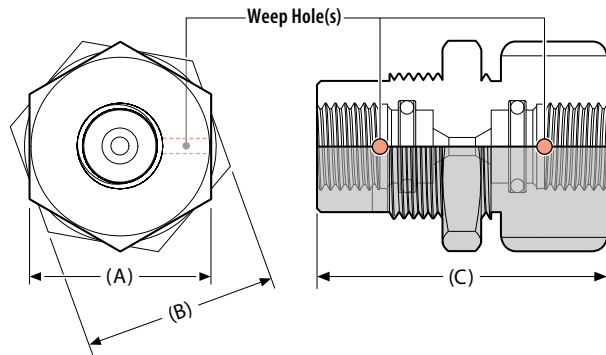

(A)	(B)	(C)	Part Number
0.938" (24 mm)	1.00" (26 mm)	1.50" (38 mm)	MPF-MPFBULK

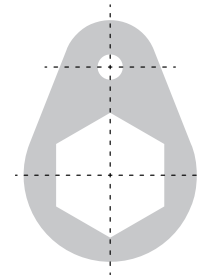

Note:
Includes bulkhead retainer (Part # 4417).

CAP

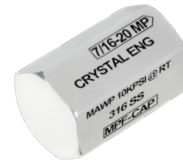
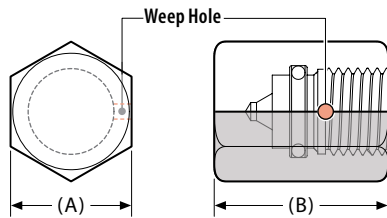

(A)	(B)	Part Number
0.63" (16 mm)	0.90" (23 mm)	MPF-CAP

PLUG

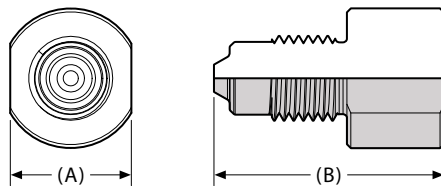

(A)	(B)	Part Number
0.63" (16 mm)	1.19" (30 mm)	MPM-PLUG

NPT Fittings

CPF MALE TO NPT MALE

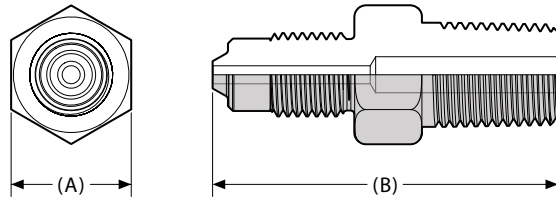

(A)	(B)	Part Number
0.63" (16 mm)	1.80" (46 mm)	MPM-1/4MPT
0.87" (22 mm)	2.02" (51 mm)	MPM-1/2MPT

NPT MALE

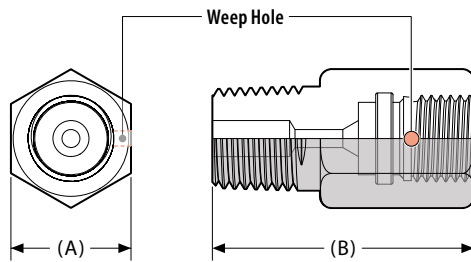

(A)	(B)	Part Number
0.63" (16 mm)	1.12" (28 mm)	MPF-1/8MPT
0.63" (16 mm)	1.36" (35 mm)	MPF-1/4MPT

NPT FEMALE

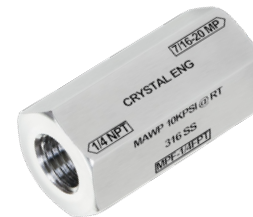
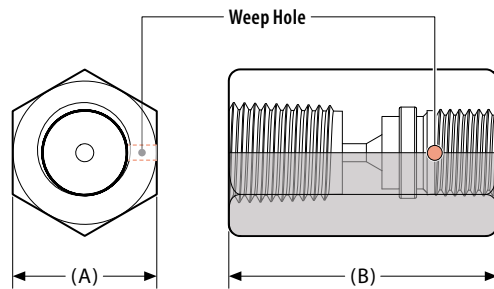

(A)	(B)	Part Number
0.75" (19 mm)	1.40" (36 mm)	MPF-1/4FPT
0.75" (19 mm)	1.40" (36 mm)	MPF15K-1/4FPT

NPT Fittings

NPT QUICK TEST MALE

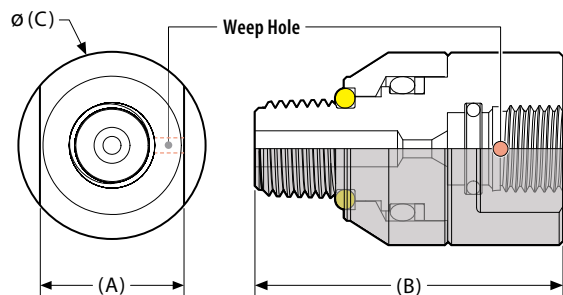

(A)	(B)	(C)	Part Number
0.63" (16 mm)	1.48" (38 mm)	1.00" (25 mm)	MPF-1/8QTM Neoprene 70 Replacement O-ring AS568A-109, #3998
0.75" (19 mm)	1.60" (41 mm)	0.82" (21 mm)	MPF-1/4QTM Neoprene 70 Replacement O-ring AS568A-111, #3996

NPT QUICK TEST FEMALE

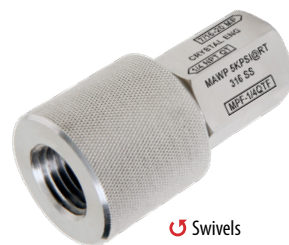
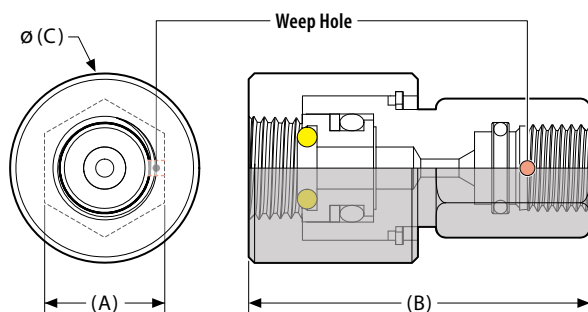

(A)	(B)	(C)	Part Number
0.63" (16 mm)	1.68" (38 mm)	0.85" (22 mm)	MPF-1/8QTF Neoprene 70 Replacement O-ring AS568A-105, #4038
0.63" (16 mm)	1.78" (45 mm)	1.00" (25 mm)	MPF-1/4QTF Neoprene 70 Replacement O-ring AS568A-108, #4007
0.63" (16 mm)	1.81" (46 mm)	1.37" (35 mm)	MPF-1/2QTF Neoprene 70 Replacement O-ring AS568A-112, #4042

Fitting rated to 5000 psi ⁵

90° NPT MALE

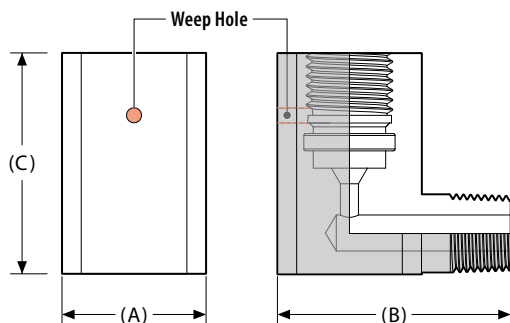

(A)	(B)	(C)	Part Number
0.75" (19 mm)	1.20" (31 mm)	1.15" (29 mm)	MPF-1/8MPT90

NPT Fittings

NPT FITTING KITS

Part Number



Complete NPT Hose and Fitting Kit

Includes: 1/8 NPT [Male (2), Male Quick Test, and Female Quick Test], 1/4 NPT [Male (2), Female, Male Quick Test, and Female Quick Test], 1/2 NPT [Female Quick Test], **Tube** [1/4 Male and 3/8 Male], **Transmitter** [5/16 Male], **CPF Connectors** [Male-Male, Plug, and Cap (2)], **Hose** [1 meter], and **Custom Carrying Case**.

4016

Quick Test NPT Kit

Includes: MPF-1/8QTF, MPF-1/4QTF, and MPF-1/2QTF.

4013

BSP Fittings

CPF MALE TO BSP MALE

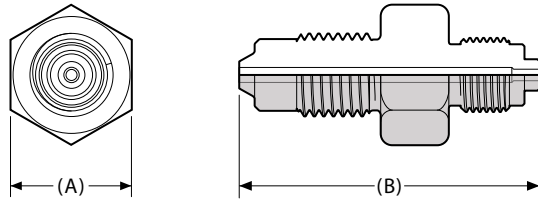

(A)	(B)	Part Number
0.63" (16 mm)	1.57" (40 mm)	MPM-1/8BSPM ¹⁵
0.83" (21 mm)	1.72" (44 mm)	MPM-1/4BSPM ¹⁵
0.95" (24 mm)	1.96" (50 mm)	MPM-3/8BSPM ¹⁵
1.14" (29 mm)	2.16" (55 mm)	MPM-1/2BSPM ¹⁵

CPF MALE TO BSP FEMALE

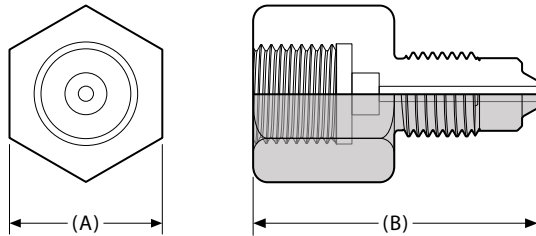

(A)	(B)	Part Number
0.63" (16 mm)	1.28" (33 mm)	MPM-1/8BSPF ¹⁵
0.79" (20 mm)	1.47" (37 mm)	MPM-1/4BSPF ¹⁵
0.98" (25 mm)	1.61" (41 mm)	MPM-3/8BSPF ¹⁵
1.18" (30 mm)	1.74" (44 mm)	MPM-1/2BSPF ¹⁵

BSP QUICK TEST FEMALE

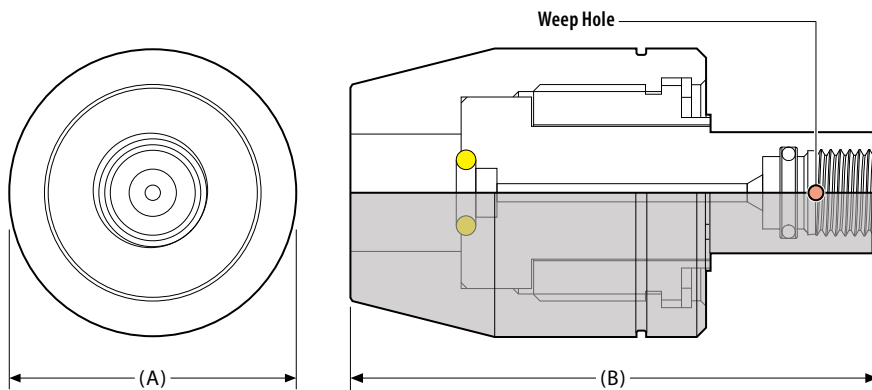

(A)	(B)	Part Number
1.50" (38 mm)	2.75" (70 mm)	MPF-1/8QTFB ¹⁵ VITON 90 Replacement O-ring AS568-008, #5804
1.50" (38 mm)	2.75" (70 mm)	MPF-1/4QTFB ¹⁵ VITON 75 Replacement O-ring AS568-009, #5786
1.50" (38 mm)	2.75" (70 mm)	MPF-3/8QTFB ¹⁵ VITON 75 Replacement O-ring AS568-108, #5783
1.50" (38 mm)	2.75" (70 mm)	MPF-1/2QTFB ¹⁵ VITON 75 Replacement O-ring AS568-109, #5784

Fittings rated to 15000 psi ¹⁵

BSP Fittings

BSP FEMALE

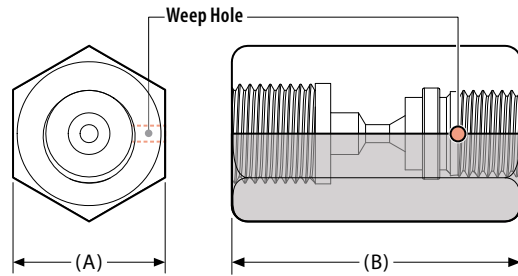

(A)	(B)	Part Number
0.79" (20 mm)	1.50" (38 mm)	MPF-1/4BSPF

BSP FITTING KITS



		Part Number
Complete BSP Hose and Fitting Kit	Includes: 1/8 BSP [Female, Male, and Female Quick Test], 1/4 BSP [Female, Male, and Female Quick Test (2)], 3/8 BSP [Female, Male, and Female Quick Test], 1/2 BSP [Female, Male, and Female Quick Test], Transmitter [5/16 Male], CPF Connectors [Male-Male, Plug, and Cap (2)], Hose [1 meter], and Custom Carrying Case.	5634
BSP Test Kit	Includes: MPF-1/8QTFB, MPF-1/4QTFB, MPF-3/8QTFB, and MPF-1/2QTFB	4015

M20 Fittings

CPF MALE TO M20 MALE

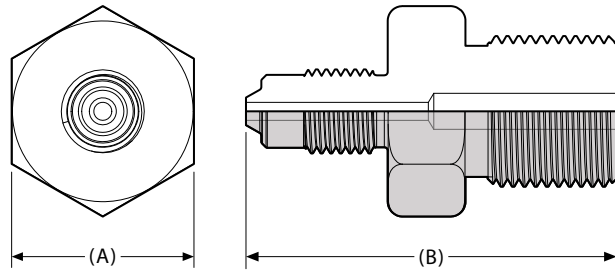

(A)	(B)	Part Number
0.95" (24 mm)	1.93" (49 mm)	MPM-M20X1.5M

M20 FEMALE

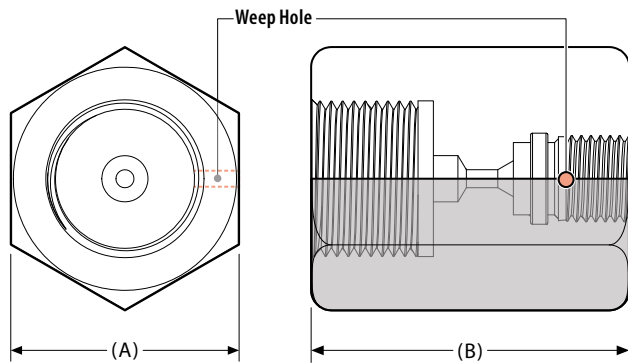

(A)	(B)	Part Number
1.18" (30 mm)	1.65" (42 mm)	MPF-M20X1.5F

M20 QUICK TEST FEMALE

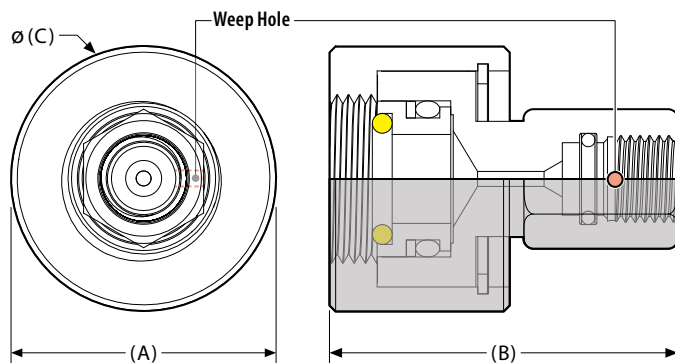

(A)	(B)	(C)	Part Number
0.63" (16 mm)	1.81" (46 mm)	1.375" (35 mm)	MPF-M20QTF
			Neoprene 70 Replacement O-ring AS568A-112, #4042

Fitting rated to 5000 psi

Transmitter Fittings

FOR FOXBORO, ROSEMOUNT, & YOKOGAWA

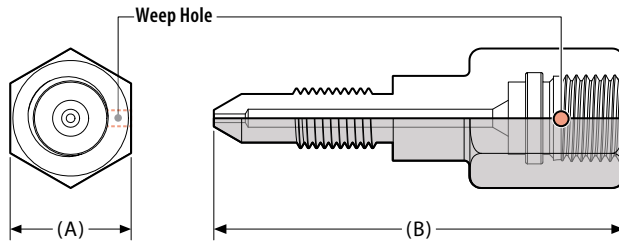

(A)	(B)	Part Number
0.63" (16 mm)	2.13" (54 mm)	MPF-5/16TRM

FOR HONEYWELL

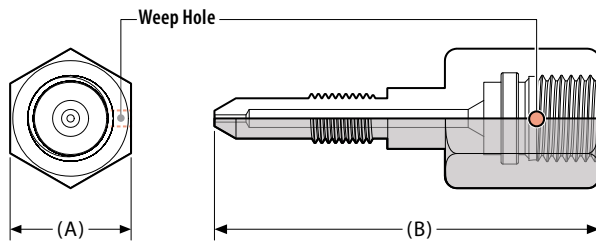

(A)	(B)	Part Number
1.18" (30 mm)	1.65" (42 mm)	MPF-1/4TRM

Tube Fitting

TUBE MALE

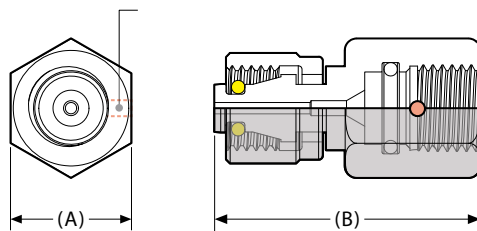

(A)	(B)	Part Number
0.63" (16 mm)	1.38" (35 mm)	MPF-1/4TBM
		VITON 90 Replacement O-ring AS568A-007, #4104
0.63" (16 mm)	1.50" (38 mm)	MPF-3/8TBM
		VITON 90 Replacement O-ring AS568A-010, #4051
0.63" (16 mm)	1.74" (44 mm)	MPF-1/2TBM
		VITON 90 Replacement O-ring AS568A-012, #3981

Fittings rated to 5000 psi

AN4 Fittings

AN4 MALE

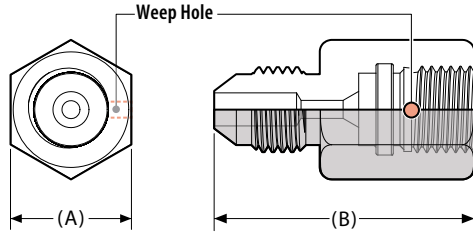

(A)	(B)	Part Number
0.63" (16 mm)	1.35" (34 mm)	MPF-AN4M 5

AN4 UNION SWIVEL (NON CRYSTAL)

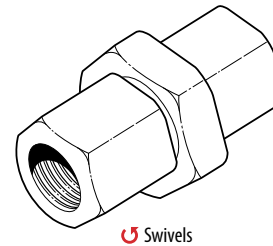
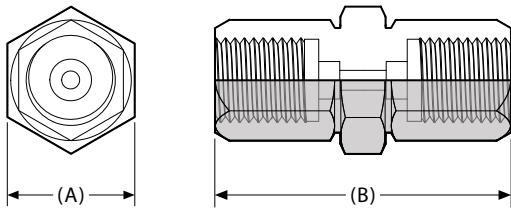

(A)	(B)	(C)	Part Number
0.56" (14 mm)	1.60" (41 mm)	0.69" (17 mm)	4377 5

Non-Crystal MP Adapters

MEDIUM PRESSURE MALE TO NPT FEMALE

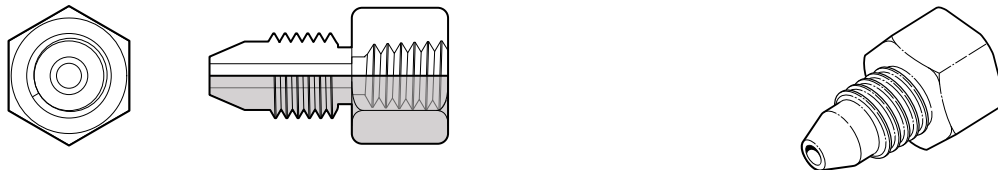

Size	Product Marking	Part Number	
1/8 NPT	2NF04M15	4497	15
1/4 NPT	4NF04M15	4498	15
3/8 NPT	6NF04M15	4499	15
1/2 NPT	8NF04M15	4500	15

MEDIUM PRESSURE MALE TO NPT MALE

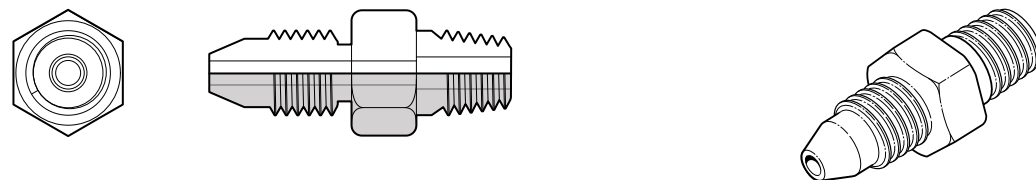

Size	Product Marking	Part Number	
1/8 NPT	2N04M15	4696	15
1/4 NPT	4N04M15	4698	15
3/8 NPT	6N04M15	4492	15
1/2 NPT	8N04M15	4493	15

MEDIUM PRESSURE FEMALE TO NPT FEMALE

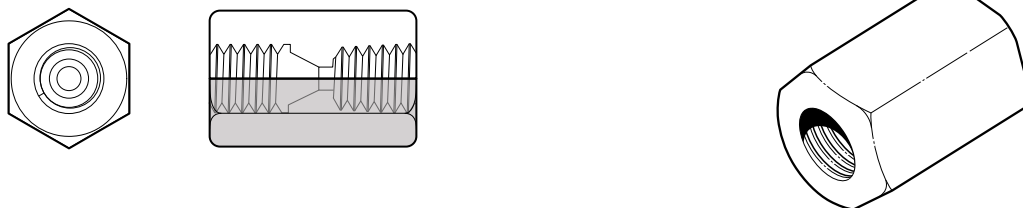

Size	Product Marking	Part Number	
1/8 NPT	2NF04MF15	4501	15
3/8 NPT	6NF04MF15	4502	15
1/2 NPT	8NF04MF15	4503	15

MEDIUM PRESSURE FEMALE TO NPT MALE

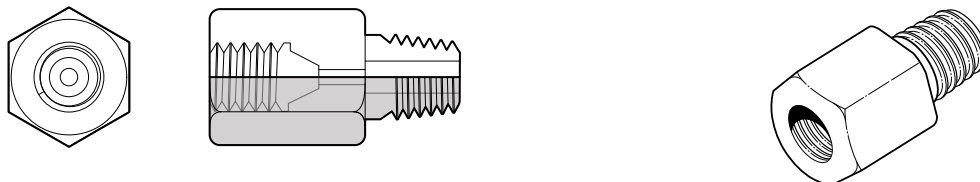

Size	Product Marking	Part Number	
1/4 NPT	4N04MF15	4714	15
3/8 NPT	6N04MF15	4494	15
1/2 NPT	8N04MF15	4495	15
3/4 NPT	12N04MF10	4496	

Fittings rated to 15000 psi 15

Non-Crystal MP adapters require wrench tightening.