

# HONEYWELL UDC1200 MICRO-PRO Universal Digital Controller Start-Up Guide Document #51-52-33-142

1. Mounting	Page 2
2. Wiring	Page 2
3. Select Mode	Page 3
4. Configuration Mode	Page 3
5. Setup Mode	Page 6
6. Operator Mode	Page 7
7. Automatic Tuning Mode	Page 8
8. Product Information Mode	Page 8
9. Installing Option Modules	Page 9
10. Error Fault Indications	Page 10



The full users manual can be downloaded from Honeywell IMC Web page  
<http://content.honeywell.com/imc/>

# HONEYWELL UDC1200 MICRO-PRO Universal Digital Controller

**CAUTION:** Installation and configuration should be performed only by personnel who are technically competent to do so. Local Regulations regarding electrical installation & safety must be observed.

## 1. INSTALLATION

### Panel-Mounting

The mounting panel must be rigid and may be up to 6.0mm (0.25 inches) thick. The cut-out required for the instrument is shown on the right. Instruments may be mounted side-by-side in a multiple installation for which the cut-out width (for  $n$  instruments) is  $(48n-4)$ mm or  $(1.89n-0.16)$ inches.

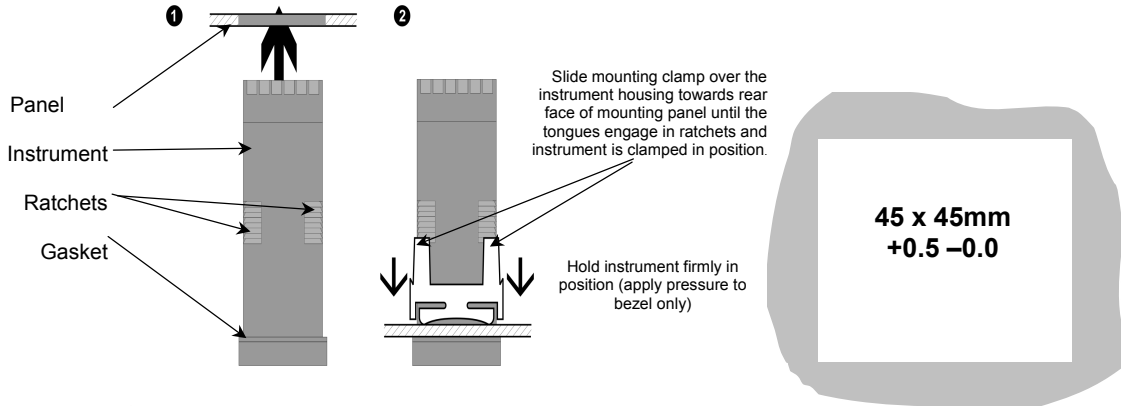

**CAUTION:** Do not remove the panel gasket; it is a seal against dust and moisture.

## 2. WIRING

### Rear Terminal Wiring

#### USE COPPER CONDUCTORS (EXCEPT FOR T/C INPUT)

Single Strand wire gauge:  
Max 1.2mm (18SWG)



**CAUTION:** Check information label on housing for correct operating voltage before connecting supply to Power Input  
Fuse: 100 – 240V ac – 1amp anti-surge  
24/48V ac/dc – 315mA anti-surge

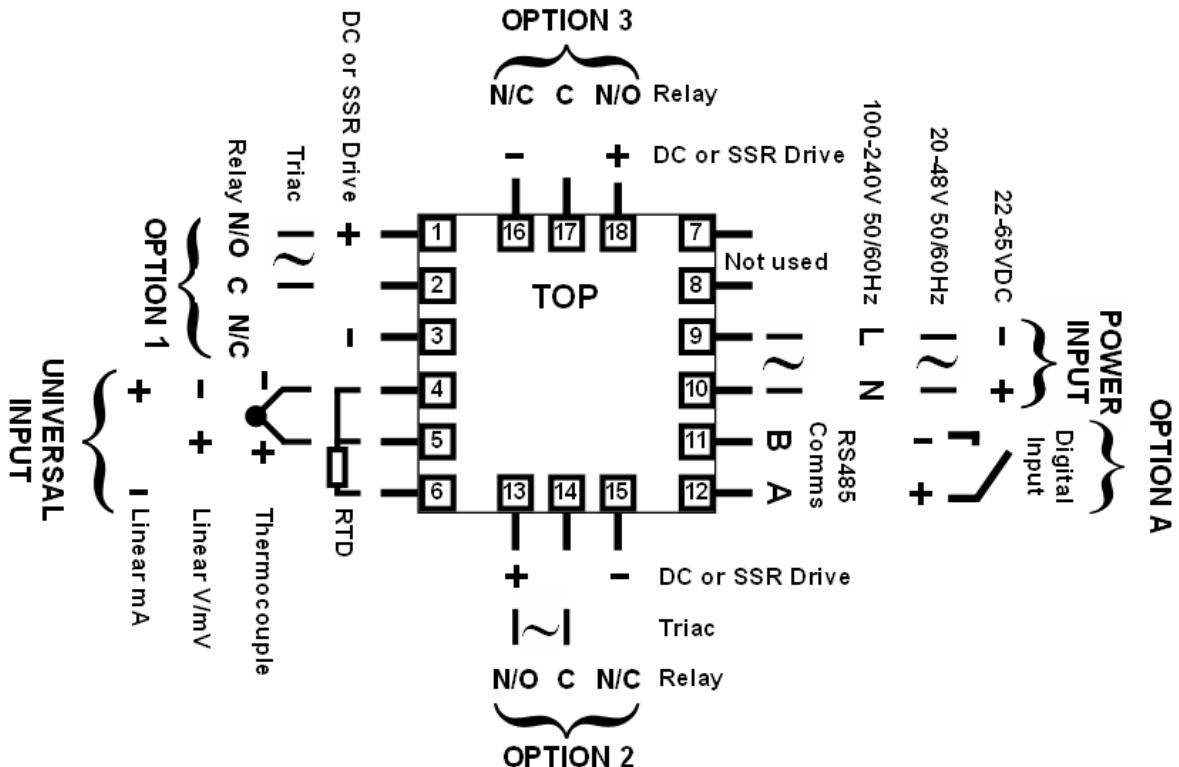

### 3. SELECT MODE

Select mode is used to access the configuration and operation menu functions. It can be accessed at any time by holding down **SETUP** and pressing **▲**.

Once in select mode, press **▲** or **▼** to select the required mode. An unlock code is required to prevent unauthorised entry to Configuration, Setup & Automatic Tuning modes.

Press **▲** or **▼** to enter the correct code number, then press **SETUP** to proceed.

Mode	Upper Display	Lower Display	Description	Default Unlock Codes
Operator	Op <sup>tr</sup>	SLC <sup>t</sup>	Normal instrument operation.	None
Set Up	Set <sup>P</sup>	SLC <sup>T</sup>	Tailor settings to the application.	10
Configuration	Conf	SLC <sup>T</sup>	Configures the instrument for use.	20
Product Info	Info	SLC <sup>T</sup>	Check manufacturing information.	None
Auto-Tuning	Atun	SLC <sup>T</sup>	Invoke Pre-Tune or Self-Tune.	0

*Note: The instrument will always return automatically to Operator mode if there is no key activity for 2 minutes.*

### 4. CONFIGURATION MODE

First select Configuration mode from Select mode (refer to section 3).

Press **SETUP** to scroll through the parameters, then press **▲** or **▼** to set the required value. To accept a change **Man Auto** must be pressed, otherwise parameter will revert to previous value. To exit from Configuration mode, hold down **SETUP** and press **▲**, to return to Select mode.

**Note: Parameters displayed depends on how instrument has been configured.**

*Parameters marked \* are repeated in Setup Mode.*

Parameter	Lower Display	Upper Display	Adjustment range	Default	
Input Range/Type	<i>mP<sup>t</sup></i>	See following table for possible codes		J T/C	
<b>Code</b>	<b>Input Type &amp; Range</b>	<b>Code</b>	<b>Input Type &amp; Range</b>	<b>Code</b> <b>Input Type &amp; Range</b>	
<i>b<sup>C</sup></i>	B: 100 – 1824 °C	<i>L<sup>C</sup></i>	L: 0.0 – 537.7 °C	<i>P24F</i>	PtRh20% vs 40%: 32 – 3362 °F
<i>b<sup>F</sup></i>	B: 211 – 3315 °F	<i>L<sup>F</sup></i>	L: 32.0 – 999.9 °F		
<i>c<sup>C</sup></i>	C: 0 – 2320 °C	<i>n<sup>C</sup></i>	N: 0 – 1399 °C	<i>Pt<sup>C</sup></i>	Pt100: -199 – 800 °C
<i>c<sup>F</sup></i>	C: 32 – 4208 °F	<i>n<sup>F</sup></i>	N: 32 – 2551 °F	<i>Pt<sup>F</sup></i>	Pt100: -328 – 1472 °F
<i>J<sup>C</sup></i>	J: -200 – 1200 °C	<i>r<sup>C</sup></i>	R: 0 – 1759 °C	<i>Pt<sup>C</sup></i>	Pt100: -128.8 – 537.7 °C
<i>J<sup>F</sup></i>	J: -328 – 2192 °F	<i>r<sup>F</sup></i>	R: 32 – 3198 °F	<i>Pt<sup>F</sup></i>	Pt100: -199.9 – 999.9 °F
<i>J<sup>C</sup></i>	J: -128.8 – 537.7 °C	<i>S<sup>C</sup></i>	S: 0 – 1762 °C	<i>0_20</i>	0 – 20 mA DC
<i>J<sup>F</sup></i>	J: -199.9 – 999.9 °F	<i>S<sup>F</sup></i>	S: 32 – 3204 °F	<i>4_20</i>	4 – 20 mA DC
<i>K<sup>C</sup></i>	K: -240 – 1373 °C	<i>t<sup>C</sup></i>	T: -240 – 400 °C	<i>0_50</i>	0 – 50 mV DC
<i>K<sup>F</sup></i>	K: -400 – 2503 °F	<i>t<sup>F</sup></i>	T: -400 – 752 °F	<i>1050</i>	10 – 50 mV DC
<i>K<sup>C</sup></i>	K: -128.8 – 537.7 °C	<i>t<sup>C</sup></i>	T: -128.8 – 400.0 °C	<i>0_5</i>	0 – 5 V DC
<i>K<sup>F</sup></i>	K: -199.9 – 999.9 °F	<i>t<sup>F</sup></i>	T: -199.9 – 752.0 °F	<i>1_5</i>	1 – 5 V DC
<i>L<sup>C</sup></i>	L: 0 – 762 °C	<i>P24C</i>	PtRh20% vs 40%: 0 – 1850 °C	<i>0_10</i>	0 – 10 V DC
<i>L<sup>F</sup></i>	L: 32 – 1403 °F			<i>2_10</i>	2 – 10 V DC
<b>Parameter</b>	<b>Lower Display</b>	<b>Upper Display</b>	<b>Adjustment range</b>	<b>Default</b>	
Scale Range Upper Limit	<i>r<sup>uL</sup></i>	Scale Range Lower Limit +100 to Range Max		Range max (Lin=1000)	
Scale Range Lower Limit	<i>r<sup>lL</sup></i>	Range Min. to Scale Range Upper Limit -100		Range min (Linear=0)	
Decimal point position	<i>dP<sup>o5</sup></i>	0=XXXX, 1=XXX.X, 2=XX.XX, 3=X.XXX (non-temperature ranges only)		1	
Control Type	<i>C<sup>tYP</sup></i>	<i>S<sup>nGL</sup></i>	Primary (heat) only	<i>S<sup>nGL</sup></i>	







Parameter	Lower Display	Upper Display	Adjustment range	Default
		<b>duAL</b>	Primary & Secondary (heat/cool)	
Primary Output Control Action	<b>Ctrl</b>	<b>rEu</b>	Reverse Acting	<b>rEu</b>
		<b>dir</b>	Direct Acting	
Alarm 1 Type	<b>ALA1</b>	<b>P_H1</b>	Process High Alarm	<b>P_H1</b>
		<b>P_Lo</b>	Process Low Alarm	
		<b>dE</b>	Deviation Alarm	
		<b>bAnd</b>	Band Alarm	
		<b>nonE</b>	No alarm	
High Alm 1 value*	<b>PhA1</b>	Range Min. to Range Max in display units		Range Max.
Low Alm 1 value*	<b>PLA1</b>			Range Min.
Band Alm 1 value*	<b>bAL1</b>	1 LSD to span from setpoint in display units		<b>5</b>
Dev. Alm 1 value*	<b>dAL1</b>	+/- Span from setpoint in display units		<b>5</b>
Alm 1 Hysteresis*	<b>AHY1</b>	1 LSD to full span in display units		<b>1</b>
Alarm 2 Type*	<b>ALA2</b>	Options as for alarm 1		<b>P_Lo</b>
High Alm 2 value*	<b>PhA2</b>			Range Max.
Low Alm 2 value*	<b>PLA2</b>			Range Min.
Band Alm 2 value*	<b>bAL2</b>			<b>5</b>
Dev. Alm 2 Value*	<b>dAL2</b>			<b>5</b>
Alm 2 Hysteresis*	<b>AHY2</b>			<b>1</b>
Loop Alarm	<b>LAEn</b>			<b>dISA</b> (disabled) or <b>EnAb</b> (enabled)
Loop Alarm Time*	<b>LAte</b>	1 sec to 99 mins. 59secs (only applies if primary proportional band = 0)		<b>99.59</b>
Alarm Inhibit	<b>Inh1</b>	<b>nonE</b>	No alarms Inhibited	<b>nonE</b>
		<b>ALA1</b>	Alarm 1 inhibited	
		<b>ALA2</b>	Alarm 2 inhibited	
		<b>both</b>	Alarm 1 and alarm 2 inhibited	
Output 1 Usage	<b>USE1</b>	<b>Pr1</b>	Primary (Heat) Power	<b>Pr1</b>
		<b>Sec</b>	Secondary (Cool) Power	
		<b>A1_d</b>	Alarm 1, Direct	
		<b>A1_r</b>	Alarm 1, Reverse	
		<b>A2_d</b>	Alarm 2, Direct	
		<b>A2_r</b>	Alarm 2, Reverse	
		<b>LP_d</b>	Loop Alarm, Direct	
		<b>LP_r</b>	Loop Alarm, Reverse	
		<b>Or_d</b>	Logical Alarm 1 OR 2, Direct	
		<b>Or_r</b>	Logical Alarm 1 OR 2, Reverse	
		<b>Ad_d</b>	Logical Alarm 1 AND 2, Direct	
		<b>Ad_r</b>	Logical Alarm 1 AND 2, Reverse	
		<b>rEtS</b>	Retransmit SP Output	
		<b>rEtP</b>	Retransmit PV Output	
Linear Output 1 Range	<b>tYP1</b>	<b>0_5</b>	0 – 5 V DC output 1	<b>0_10</b>
		<b>0_10</b>	0 – 10 V DC output	
		<b>2_10</b>	2 – 10 V DC output	
		<b>0_20</b>	0 – 20 mA DC output	

Parameter	Lower Display	Upper Display	Adjustment range	Default
		4_20	4 – 20 mA DC output	
Retransmit Output 1 Scale maximum	ro1H	-1999 to 9999 (display value at which output will be maximum)		Range max
Retransmit Output 1 Scale minimum	ro1L	-1999 to 9999 (display value at which output will be minimum)		Range min
Output 2 Usage	USE2		As for output 1	Sec or Δ12
Lin. O/P 2 Range	tYP2			0_10
Retransmit Output 2 Scale maximum	ro2H	-1999 to 9999 (display value at which output will be maximum)		Range max
Retransmit Output 2 Scale minimum	ro2L	-1999 to 9999 (display value at which output will be minimum)		Range min
Output 3 Usage	USE3		As for output 1	A1_d
Linear Output 3 Range	tYP3			0_10
Retransmit Output 3 Scale maximum	ro3H	-1999 to 9999 (display value at which output will be maximum)		Range max
Retransmit Output 3 Scale minimum	ro3L	-1999 to 9999 (display value at which output will be minimum)		Range min
Display Strategy	dISP		1, 2, 3, 4, 5 or 6 (refer to section 7)	1
Comms Protocol	Prot	ASC 1	ASCII	r7bn
		r7b	Modbus with no parity	
		r7b E	Modbus with Even Parity	
		r7b O	Modbus with Odd Parity	
Bit rate	bAud	1.2	1.2 kbps	4.8
		2.4	2.4 kbps	
		4.8	4.8 kbps	
		9.6	9.6 kbps	
		19.2	19.2 kbps	
Comms Address	Addr	1	1 – 255 (Modbus), 1-99 (ASCII)	1
Comms Write	CoEn		Read only or read/write	r_w
Digital Input Usage	dIU	dS1	Setpoint 1 / Setpoint 2 select	dS1
		dAS	Automatic / Manual select	
Config Lock Code	CLoc		0 to 9999	20

\* Refer to the full user guide for further details on these parameters.

## 5. SETUP MODE

**Note: Configuration must be completed before adjusting Setup parameters.**

First select Setup mode from Select mode (refer to section 3). While in Setup Mode  is lit. Press  to scroll through the parameters, then press  or  to set the required value. To exit from Setup mode, hold down  and press , to return to Select mode.



**Note: Parameters displayed depends on how instrument has been configured.**

Parameter	Lower Display	Upper Display Adjustment Range	Default
Input Filter Time constant	FILT	OFF or 0.5 to 100.0 secs	2.0
Process Variable Offset	OFFS	+/- Span of controller	0
Primary (Heat) power	PPWJ	Current power levels (read only)	N/A
Secondary (Cool) power	SPWJ		
Primary Proportional Band	Pb_P	0.0% (ON/OFF) and 0.5% to 999.9% of input span.	10.0
Secondary Proportional Band	Pb_S		
Automatic Reset (Integral Time)	ARSt	1 sec to 99 mins 59 secs and OFF	5.00
Rate (Derivative Time)	rAtE	00 secs to 99 mins 59 secs	1.15
Overlap/Deadband	OL	-20 to +20% of Primary and Secondary Proportional Band	0
Manual Reset (Bias)	bAS	0%(-100% if dual control) to 100%	25
Primary ON/OFF Differential	dIFP	0.1% to 10.0% of input span centered about the setpoint	0.5
Secondary ON/OFF Diff.	dIFS		
Prim. & Sec. ON/OFF Diff.	dIFF		
Setpoint Upper Limit	SPuL	Current Setpoint to Range max	R/max
Setpoint Lower limit	SPLL	Range min to Current Setpoint	R/min
Primary Output Power Limit	OPuL	0% to 100% of full power.	100
Output 1 Cycle Time	Ct1	0.5, 1, 2, 4, 8, 16, 32, 64, 128, 256 or 512 secs.	32
Output 2 Cycle Time	Ct2		
Output 3 Cycle Time	Ct3		
High Alarm 1 value	PhA1	Range Min. to Range Max.	R/max
Low Alarm 1 value	PLA1		R/min
Deviation Alarm 1 Value	dAL1	+/- Span from SP in display units	5
Band Alarm 1 value	bAL1	1 LSD to span from setpoint	5
Alarm 1 Hysteresis	AHY1	1 LSD to full span in display units	1
High Alarm 2 value	PhA2	Range Min. to Range Max.	R/max
Low Alarm 2 value	PLA2		R/min
Deviation Alarm 2 Value	dAL2	+/- Span from SP in display units	5
Band Alarm 2 value	bAL2	1 LSD to span from setpoint	5
Alarm 2 Hysteresis	AHY2	1 LSD to full span in display units	1
Loop Alarm Time	LAET	1 sec to 99 mins. 59secs.	99.59
Auto Pre-tune	APt	dISA disabled or EnAb enabled	dISA
Auto/manual Control selection	POEn		
Setpoint ramping	SPr		
SP Ramp Rate Value	rP	1 to 9999 units/hour or Off (blank)	Off
SP Value	SP	Scale range upper to lower limits	Scale Range min
SP1 Value	-SP1	Scale range upper to lower limits	
SP2 Value	-SP2	"_" indicates currently active SP.	
Setup Lock Code	SLoc	0 to 9999	10



## 6. OPERATOR MODE

This mode is entered at power on. It can also be accessed from Select mode (see section 3).



**Note: All configuration mode and Setup mode parameters must be set as required before starting normal operations.**



Press  to scroll through the parameters, then press  or  to set the required value.

**Note: All parameters in Display strategy 6 are read only, and can only be adjusted via Setup mode.**

Upper Display	Lower Display	Display Strategy When Visible	Description
PV Value	Active SP Value	1 & 2 (initial screen)	PV and target value of selected SP <i>SP adjustable in Strategy 2</i>
PV Value	Actual SP Value	3 & 6 (initial screen)	PV and actual value of selected SP (e.g. ramping SP value). <b>Read only</b>
PV Value	(Blank)	4 (initial screen)	Process variable only. <b>Read only</b>
Active SP Value	(Blank)	5 (initial screen)	Target value of selected setpoint only. <b>Read only</b>
<b>SP Value</b>	<b>SP</b>	1, 3, 4, 5 & 6 if digital input is not <b>d IS I</b>	<b>Target value of SP</b>  <i>Adjustable except in Strategy 6</i>
SP1 Value	<b>- SP1</b>	"-"lit if dig I/P = <b>d IS I</b> and active SP is SP1	Target value of SP1 <i>Adjustable except in Strategy 6</i>
SP2 Value	<b>- SP2</b>	"-"lit if dig I/P = <b>d IS I</b> and active SP is SP2	Target value of SP2 <i>Adjustable except in Strategy 6</i>
Actual SP Value	<b>SP-rP</b>	<b>SP-r</b> enabled and <b>rP</b> is not zero	Actual (ramping) value of selected SP <b>Read only</b>
Ramp Rate	<b>rP</b>	<b>SP-r</b> enabled in Setup mode	SP ramping rate, in units per hour. <i>Adjustable except in Strategy 6</i>
Active Alarms	<b>ALSt</b>	When one or more alarms are active.  <b>ALM</b> indicator will also flash	 Alarm 2 active Alarm 1 active Loop Alarm active

### Manual Control



If **POEn** is set to **EnAb** in Setup mode, manual control can be selected/de-selected by pressing the  key while in Operator mode, or by changing the status of the digital input if **d I I** has been configured for **d IS** in Configuration mode. The  indicator will flash while in Manual Control mode and the lower display will show **P<sub>xxx</sub>** (where xxx is the current manual power level). Switching to/from manual mode is via Bumpless Transfer.

Press  or  to set the required output power.

**Caution: Not restricted by OPUL limit.**

## 7. AUTOMATIC TUNING MODE

First select Automatic tuning mode from Select mode (refer to section 3).

Press **SETUP** to scroll through the modes, then press  or  to set the required value. To exit from Automatic tuning mode, hold down **SETUP** and press  to return to Select mode. Pre-tune is a single-shot routine and is thus self-disengaging when complete. If **APt** in Setup mode = **EnAb**, Pre-tune will attempt to run at every power up\*. Refer to the full user guide (available from your supplier) for details on controller tuning.

Parameter	Lower Display	Upper Display Adjustment Range	Default
Pre-Tune	<b>Ptun</b>	<b>On</b> or <b>OFF</b> . Indication remains <b>OFF</b> if automatic tuning cannot be used at this time*.	<b>OFF</b>
Self-Tune	<b>Stun</b>		
Tune Lock	<b>tLoc</b>	0 to 9999	<b>0</b>

**\* Note: Automatic tuning will not engage if either proportional band = 0. Also, Pre-tune will not engage if setpoint is ramping, or the PV is within 5% of span of the setpoint.**

## 8. PRODUCT INFORMATION MODE

First select Product information mode from Select mode (refer to section 3).

Press **SETUP** to view each parameter. To exit from Product Information mode, hold down **SETUP** and press  to return to Select mode. **Note: These parameters are all read only.**

Parameter	Lower Display	Upper Display	Description
Input type	<b>In_1</b>	<b>Un_1</b>	Universal input only
Option 1 module type fitted	<b>OPn1</b>	<b>nonE</b>	No option fitted.
		<b>rLY</b>	Relay
		<b>SSr</b>	SSR drive
		<b>tR_1</b>	Triac
		<b>L in</b>	Linear voltage / Current output
Option 2 type fitted	<b>OPn2</b>		As Option 1.
Option 3 type fitted	<b>OPn3</b>		As Option 1.
Auxiliary Option module type fitted	<b>OPnA</b>	<b>nonE</b>	No option fitted
		<b>r485</b>	RS485 comms
		<b>dIG_1</b>	Digital Input
Firmware type	<b>FLJ</b>		Value displayed is firmware type number
Firmware issue	<b>ISS</b>		Value displayed is firmware issue number
Product Revision Level	<b>PrL</b>		Value displayed is Product Revision level.
Date of manufacture	<b>d0r7</b>		Manufacturing date code (mmyy)
Serial number 1	<b>Sn1</b>		First four digits of serial number
Serial number 2	<b>Sn2</b>		Middle four digits of serial number
Serial number 3	<b>Sn3</b>		Last four digits of serial number



## 9. Installing Option Modules



**CAUTION:** Turn off all power. Remove instrument by gripping the sides of the front panel and pulling the instrument out of its housing. **Note its orientation.**



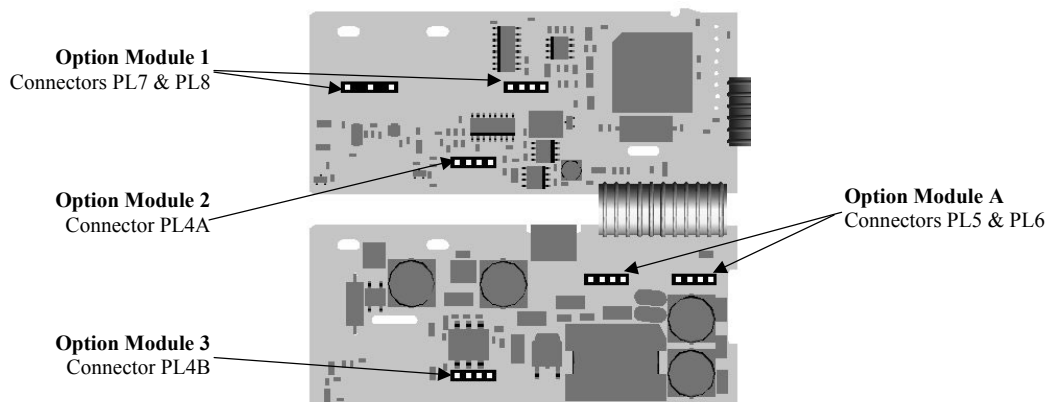
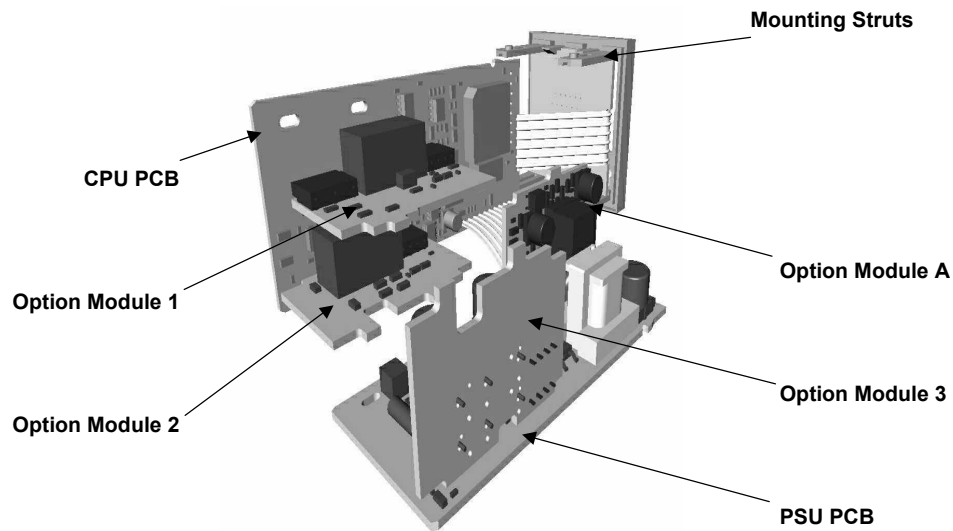

To access modules 1 or A, first detach the PSU and CPU boards from the front moulding by lifting first the upper, and then lower mounting struts. Gently separate the boards.

- Plug the required option modules into the correct connectors, as shown below.
- Locate the tongues on each module into the corresponding slot in the board opposite.
- Hold the main boards together while relocating them back on the mounting struts.
- Replace the instrument by aligning the CPU and PSU boards with their guides in the housing, then slowly push the instrument back into position.

**Note:** The instrument will automatically detect which option modules have been fitted.



## 10. ERROR/FAULT INDICATIONS

Parameter	Upper Display	Lower Display	Description
Instrument parameters are in default conditions	<i>Goto</i>	<i>Conf</i>	Configuration & Setup required. Seen at first turn on or if hardware configuration changed. Press  to enter the Configuration Mode, next press  or  to enter the unlock code number, then press  to proceed.
Over Range	<i>[HH]</i>	Normal	Input > 5% over-range
Under Range	<i>[LL]</i>	Normal	Input > 5% under-range
Sensor Break	<i>OPEN</i>	Normal	Break in input sensor or wiring
Option 1 Error	<i>Err</i>	<i>OPn1</i>	Option 1 module fault
Option 2 Error		<i>OPn2</i>	Option 2 module fault
Option 3 Error		<i>OPn3</i>	Option 3 module fault
Option A Error		<i>OPnA</i>	Auxiliary Option module fault