

Quick Start Manual



Read the user's manual carefully before starting to use the unit or software. Producer reserves the right to implement changes without prior notice.

Symbol Explanation



This symbol denotes especially important guidelines concerning the installation and operation of the device. Not complying with the guidelines denoted by this symbol may cause an accident, damage or equipment destruction.

Basic Requirements | User Safety



- Do not use the unit in areas threatened with excessive shocks, vibrations, dust, humidity, corrosive gasses and oils.
- Do not use the unit in areas where there is risk of explosions.
- Do not use the unit in areas with significant temperature variations, exposure to condensation or ice.
- The manufacturer is not responsible for any damages caused by inappropriate installation, not maintaining the proper environmental conditions and using the unit contrary to its assignment.
- If in the case of a unit malfunction there is a risk of a serious threat to the safety of people or property additional, independent systems and solutions to prevent such a threat must be used.
- The unit uses dangerous voltage that can cause a lethal accident. The unit must be switched off and disconnected from the power supply prior to starting installation of troubleshooting (in the case of malfunction).
- Do not attempt to disassemble, repair or modify the unit yourself. The unit has no user serviceable parts.
- Defective units must be disconnected and submitted for repairs at an authorized service center.

Specifications

General	
Display	LED 4 x 20mm High Adjustable Color & Brightness
Displayed Values	-999 - 9999
Transmission Parameters	1200...115200 bit/s, 8N1 / 8N2
Input Signal Supply	
Standard	Universal Input: 0 4-20mA 0-10V 0-150mV RTD pH
Voltage	85 - 260V AC/DC 16 - 35V AC, 19 - 50V DC*
Output Signal Supply	
Standard	ITC450: 4 x Relays (5A) 2 x Relays (5A) + 4-20mA · ITC350: 1 x Relay (5A) + 4-20mA
Voltage	24VDC
Passive current output*	4-20mA (Operating Range Max. 2.8 - 24mA)
Performance	
Accuracy	0.1% @ 25°C One Digit
Accuracy According to IEC 60770 - Limit Point Adjustment Non-Linearity Hysteresis Repeatability	
Temperatures	
Operating Temperatures	-40 - 158°F -40 - 70°C
Materials Wetted	
Housing	NORYL

*Contact Factory for different options

Model Selection

ITC 450 — Industrial Level Controller		
Part Number	Input	Output
ITC 450-1121	4-20 mA	4 Relay
ITC 450-1129	4-20 mA	4-20 mA + 2 Relay

ITC 350 — Industrial Level Controller		
Part Number	Input	Output
ITC 350-1119	4-20 mA	-
ITC 350-1120	4-20 mA	4-20 mA + 1x (5A) Relay



LevelPro® — ITC 450 & 350 Series

Tank Level Display + Controller



Features

Super 'Sunbright'
LED Display
8 Levels of Brightness



Rugged
Panel Mount
Design

24VDC
Power Supply
to Sensor

ENC-100 NEMA 4X Enclosure
+ ITC 450 Display (Optional)

LP100
Junction Box

4-20mA



ITC 450 Display +
ENC-100 Enclosure
(Optional)

100 Series
Submersible
Level Sensor

ITC 450

4 Configurable
(5 AMP) Relays

Push Button
Programming



Optional Remote

1 Configurable
(5A) Relay

ITC 350

Function of Push Buttons



Symbol used in the manual : [ESC/MENU]

Functions:

- Enter to main menu (press and hold for at least 3 sec.)
- Exit the current Screen and Enter to previous menu (or measure mode)
- Cancel the changes made in parameter being edited



Symbol used in the manual : [ENTER]

Functions:

- Start to edit the parameter
- Enter into the sub-menu
- Confirmation of changes made in parameter being edited



Symbol used in the manual : [^] [v]

Functions:

- Change of the present menu
- Modification of the parameter value
- Change of the display mode

Device Installation

1. The unit is designed for mounting inside housings (control panel, switchboard) insuring appropriate protection against surges and interference. Metal housings must be connected to ground in a way that complies with the governing regulations.
2. Disconnect the power supply prior to starting assembly.
3. Check the connections are wired correctly prior to switching the unit on.

In order to install the unit, a 90.5 x 43 mm mounting hole (Figure A, B) must be prepared. The thickness of the material of which the panel is made must not exceed 5mm. When preparing the mounting hole take the grooves for catches located on both sides of the housing into consideration (Figure A, B). Place the unit in the mounting hole inserting it from the front side of the panel, and then fix it using the brackets (Figure C). The minimum distances between the centre points of multiple units - due to the thermal and mechanical conditions of operation - are 115 mm x 67mm (Figure D).

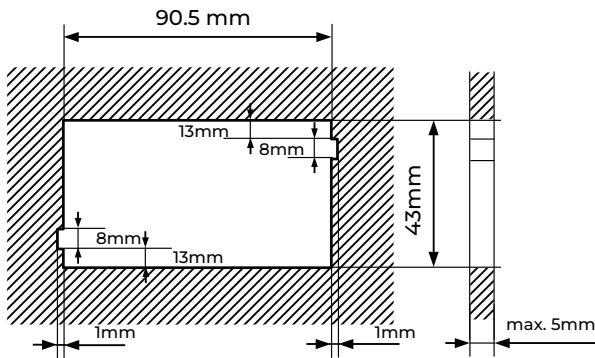

Figure A. — Recommended mounting hole dimensions

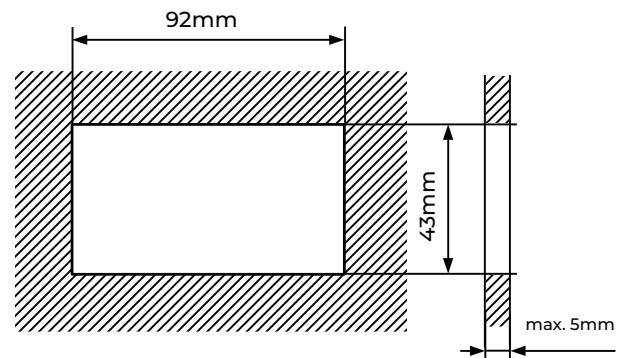

Figure B. — Allowable mounting hole dimensions

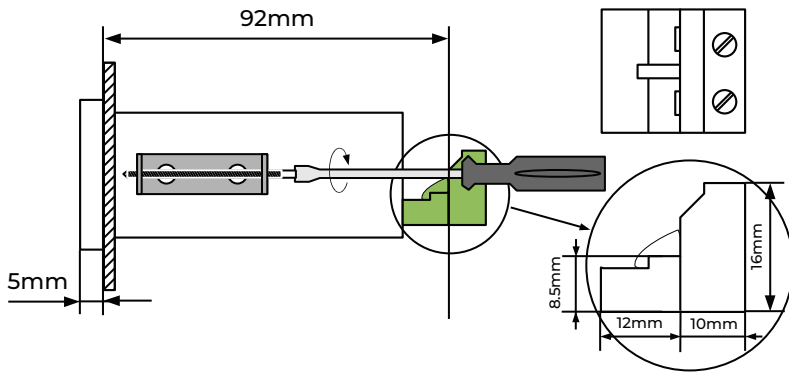

Figure C. Installing of brackets, and dimensions of connectors

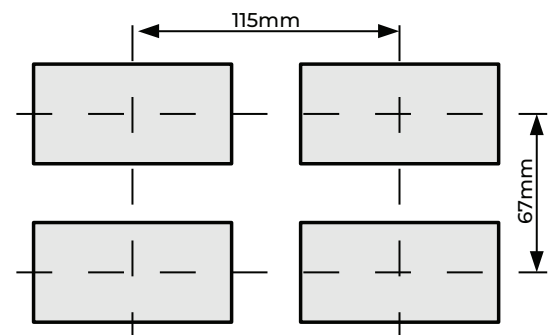
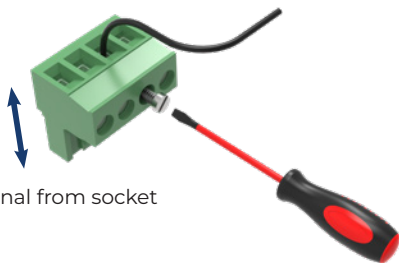

Figure D. Minimum distances when assembly of a number of units

WIRE INSTALLATION

- Carefully remove wire terminal from socket
- Loosen set screw
- Insert wire
- Tighten set screw
- Replace wire terminal into socket



Due to possible significant interference in industrial installations, appropriate measures assuring correct operation of the unit must be applied.

The unit is not equipped with an internal fuse or power supply circuit breaker. For this reason, an external time-delay cut-out fuse with a small nominal current value must be used (recommended bipolar, max. 2A) and a power supply circuitbreaker located near the unit. In the case of using a monopolar fuse it must be mounted on the phase cable.

Wiring Diagrams



All connections must be made while power supply is disconnected.

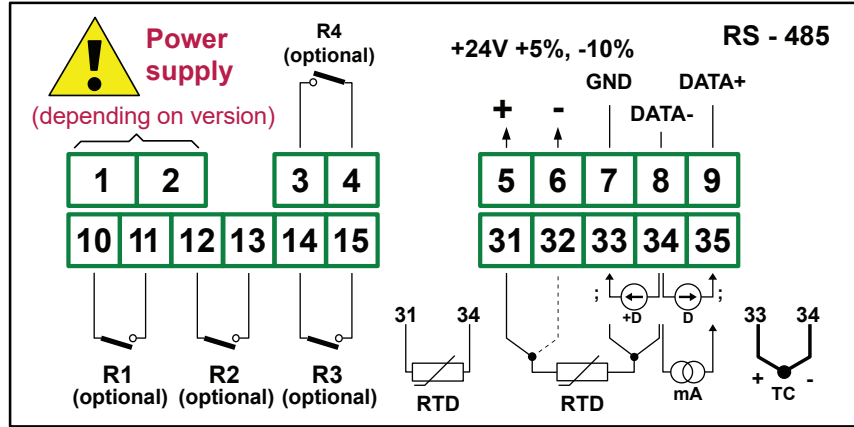

Figure E. — Terminals description (relay outputs)

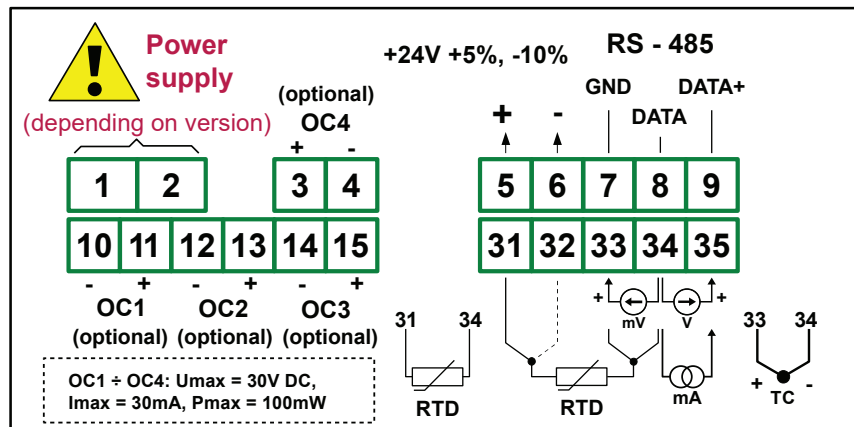

Figure F. — Terminals description (OC-type outputs)

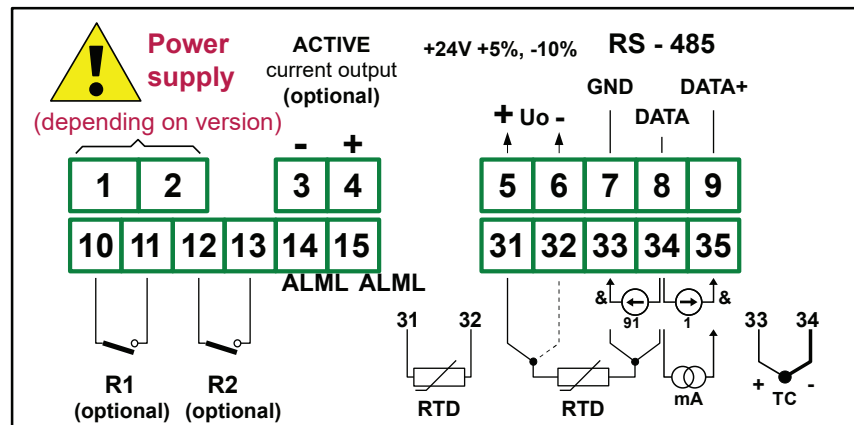

Figure G. — Terminals description (relay and active current outputs)

Wiring Diagrams



All connections must be made while power supply is disconnected.

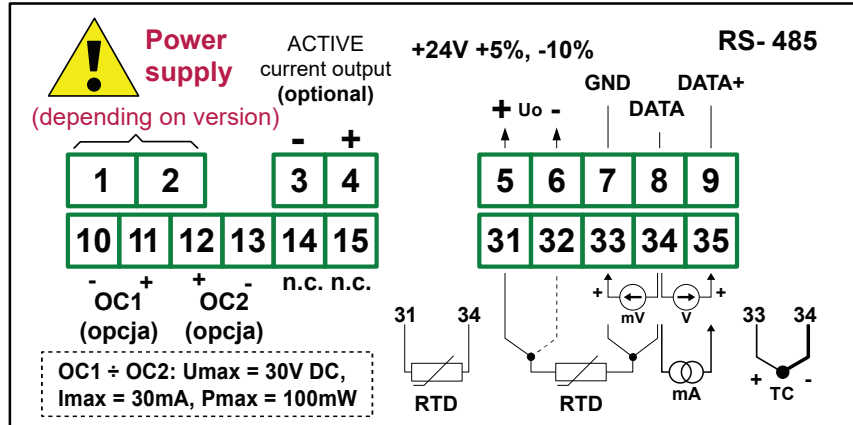

Figure H. — Terminals description (OC-type and active current outputs)

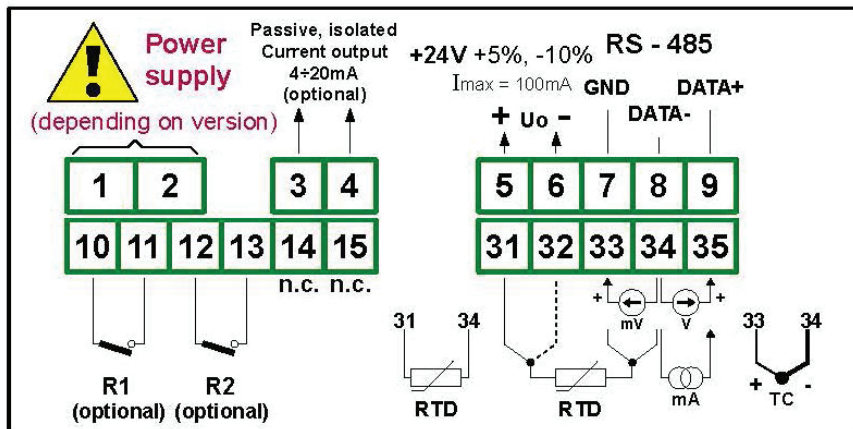

Figure I. — Terminals description (relay and passive current outputs)

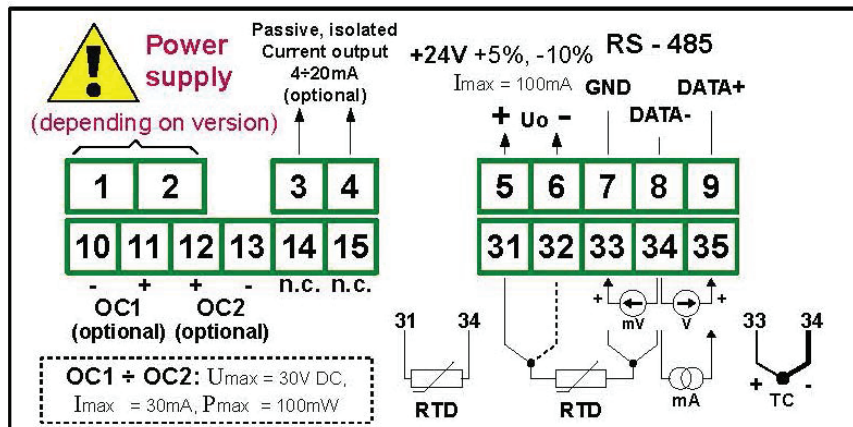

Figure J. — Terminals description (OC-type and passive current outputs)

Wiring Diagrams



All connections must be made while power supply is disconnected.

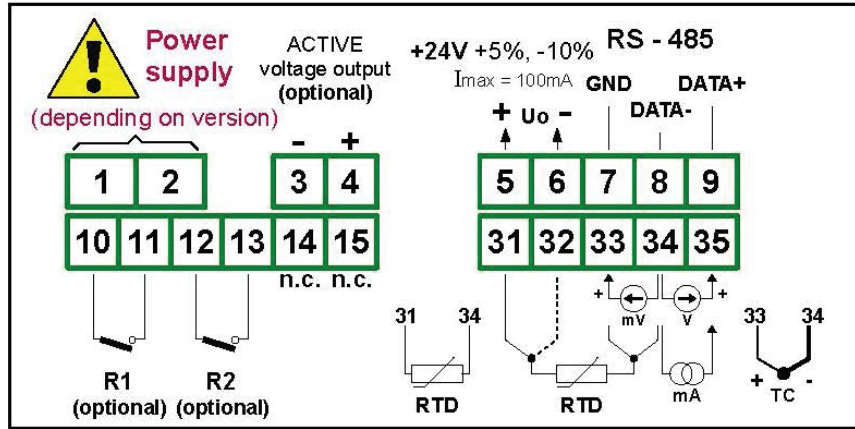

Figure K. — Terminals description (relay and active voltage outputs)

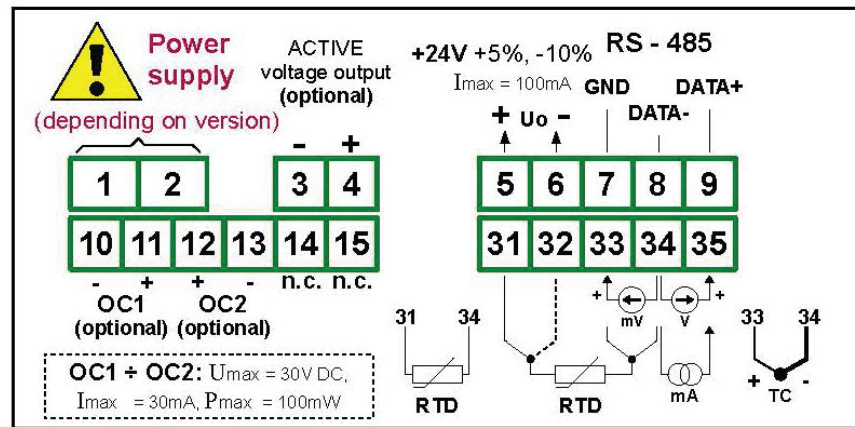

Figure L. — Terminals description (OC-type and active voltage outputs)

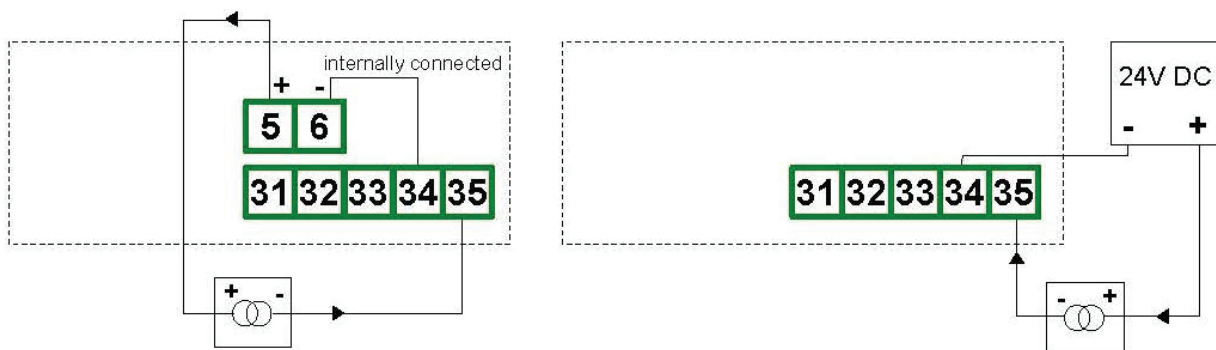

Figure M. — Connection of 2-wire current converters

Wiring Diagrams



All connections must be made while power supply is disconnected.

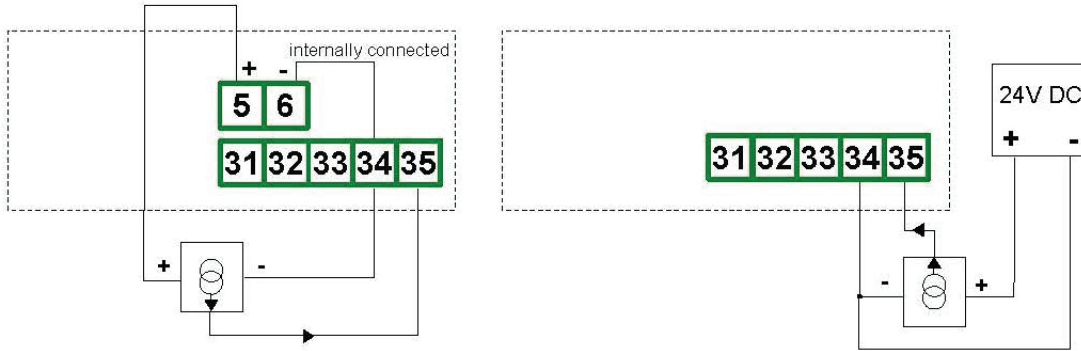

Figure N. — Connection of 3-wire current converters

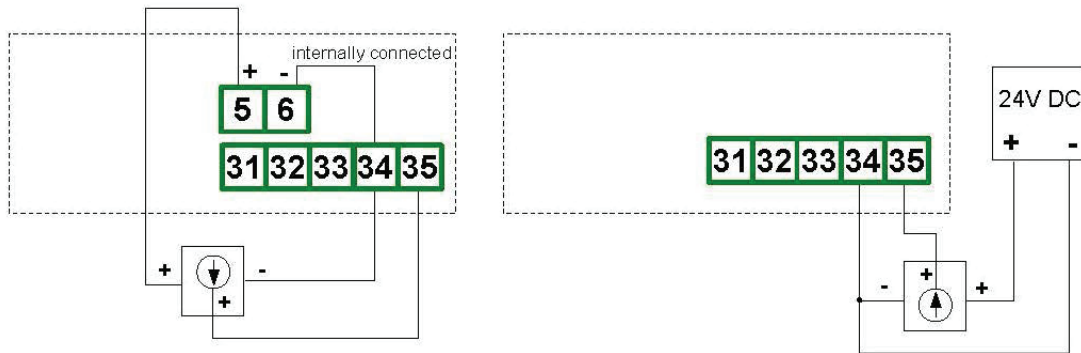

Figure O. — Connection of voltage converters

Temperature sensor can be connected to the device in typical 4-wire circuit (**Figure P-a**) or 3-wire circuit (**Figure P-b**). Due to precision of measurement 4-wire circuit is recommended.



If 2 wire circuit is used, the resistance of wires should be as small as possible, to avoid of measurement errors. Measured value can be corrected (constant correcton) using "toFS" parameter from menu "inPt". Due to low precision 2-wire connection is not recommended.

When 4-wires or 2-wires connection is used, the resistance of particular wires ($R_a \div R_d$) CAN BE DIFFERENT. When 3-wires connection is used, the resistance of particular wires ($R_a \div R_d$) MUST BE IDENTICAL to enable proper compensation of it's resistance. The resistance of particular wire should not be greater than 20Ω .

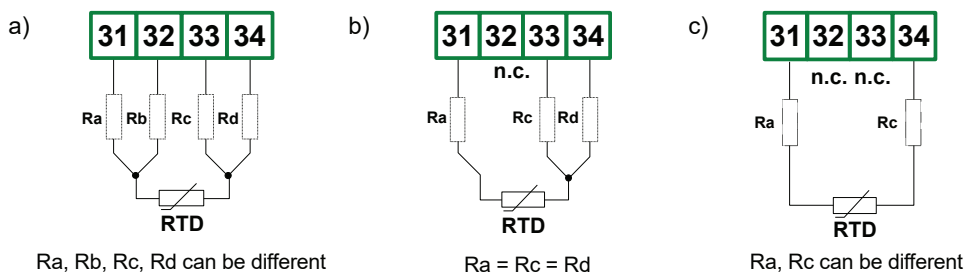

Figure P. — Connection of RTD sensors:

a) 4-wires circuit; b) 3-wires circuit; c) 2-wires circuit

Wiring Diagrams



All connections must be made while power supply is disconnected.



The connection circuit should not be changed while unit is powered. While using TC, RTD or voltage inputs (0-150mV) the device is able to detect wire breaks. Wire breaks are detected within about 2 seconds. For connectors number 32 and 33 of RTD input it may take up to about 7 seconds. During detection measurements will be incorrect. If wire break is detected "S.Err" (sensor error) message is displayed.

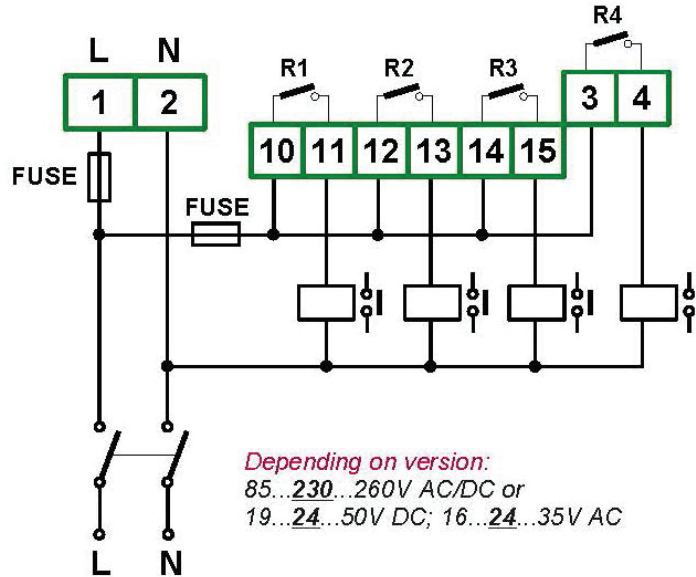

Figure Q. — Connection of power supply and relays

Contacts of relay outputs are not equipped with spark suppressors. While use the relay outputs for switching of inductive loads (coils, contactors, power relays, electromagnets, motors etc.) it is required to use additional suppression circuit (typically capacitor 47nF/ min. 250VAC in series with 100R/5W resistor), connected in parallel to relay terminals or (better) directly on the load. In consequence of using the suppression circuit, the level of generated electromagnetic disturbances is lower, and the life of relay contacts rises.

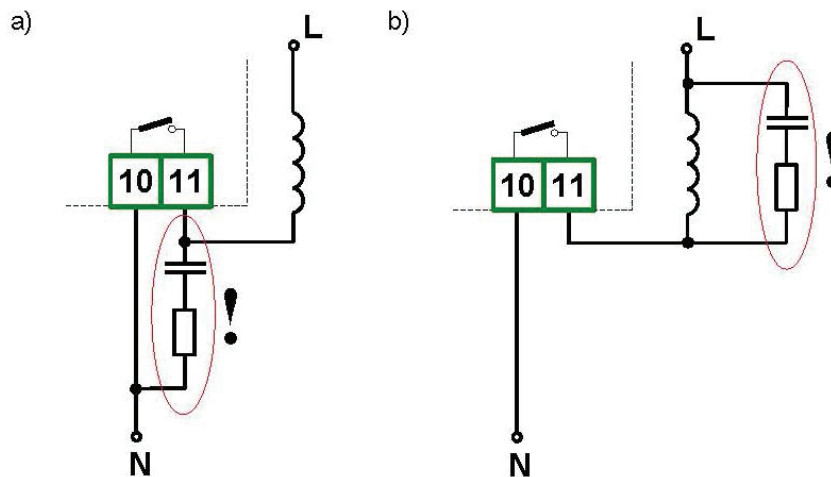

Figure R. — Examples of suppression circuit connection:

a) to relay terminals; b) to the inductive load

Wiring Diagrams



All connections must be made while power supply is disconnected.

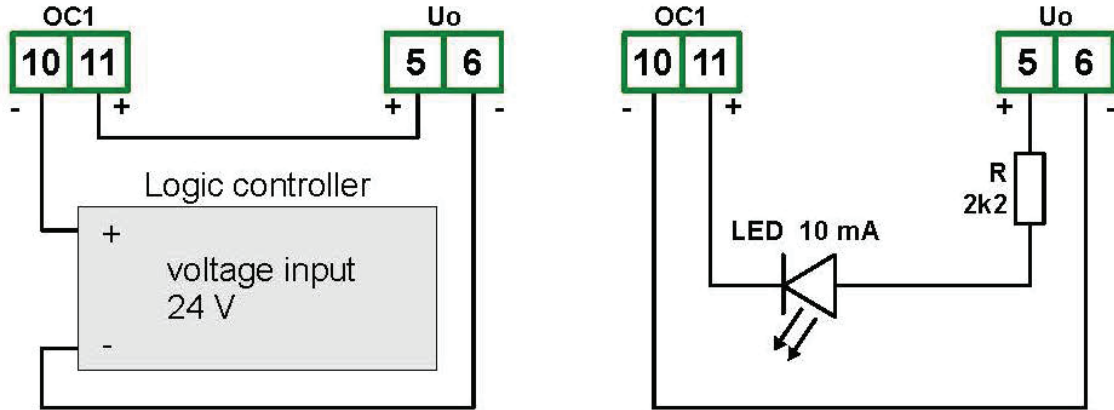

Figure S. — Example of OC-type outputs connection

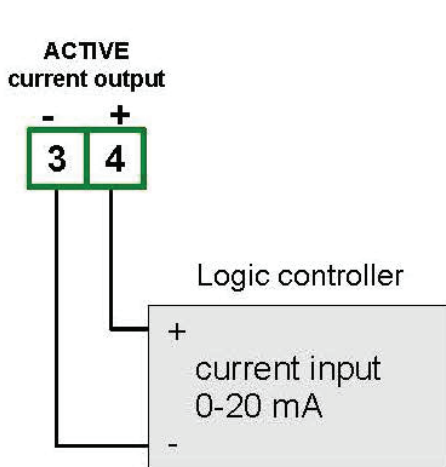

Figure T. — Example of active current outputs connection (for device with active current output only)

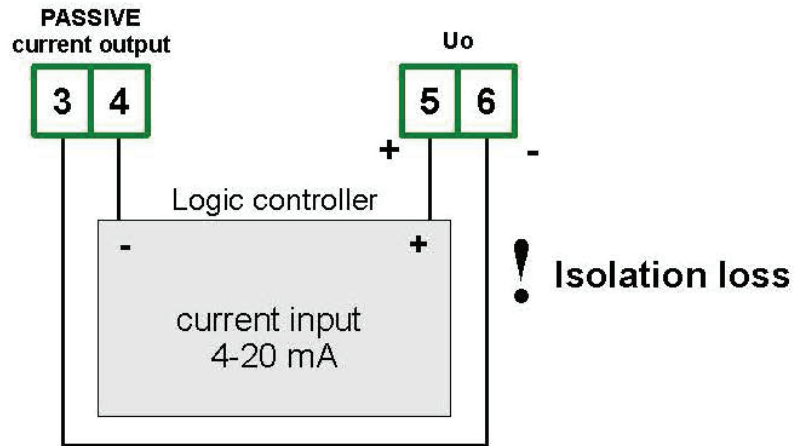

Figure U. — Example of passive current outputs connection (for device with passive current output only)

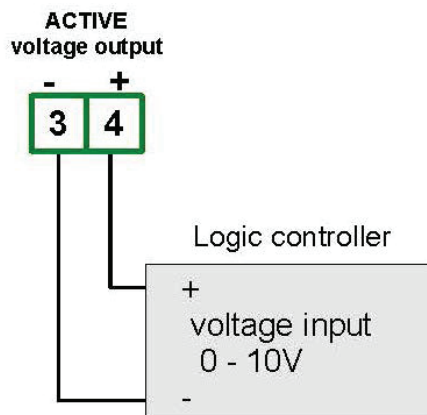





























































Figure V. — Example of active voltage outputs connection (for device with active output only)

Programming 4-20mA Input

STEPS	DISPLAY	OPERATION
1 Main Display  ESC MENU 3 SEC		MAIN DISPLAY
2 Relay 1  5x <small>Note: 2x for ITC 350</small>		RELAY 1 Settings
3 Input  ENTER		INPUT Menu
4 Type  4x		INPUT Type
5 Low C  ENTER		Enter LOW C 4mA Std = 0
6 Set 4mA Value  ENTER 2 SEC		Press  or  to change digit Press  to advance to next digit
7 Save Value  ENTER + 		SAVE SELECTION and advance to High C
8 High C  ENTER		Enter HIGH C 20mA
9 Set 20mA Value  ENTER 2 SEC		Press  or  to change digit Press  to advance to next digit
10 Save Value  ENTER		SAVE SELECTION
11 Return to Main Display  ESC MENU 2x		Return to MAIN DISPLAY

Programming 4-20mA Output

STEPS	DISPLAY	OPERATION
1 Main Display  ESC MENU 3 SEC		MAIN DISPLAY
2 Relay 1  6x <small>Note: 3x for ITC 350</small>		RELAY 1 Settings
3 Output  ENTER		OUTPUT MENU
4 Output Mode 		OUTPUT MODE
5 Output Low  ENTER		Enter OUTPUT LOW 4mA Std = 0
6 Set 4mA Value  ENTER 2 SEC		Press  or  to change digit Press  to advance to next digit
7 Save Value  ENTER + 		Save Selection and advance to Output High
8 Output High  ENTER		Enter OUTPUT High 20mA
9 Set 20mA Value  ENTER 2 SEC		Press  or  to change digit Press  to advance to next digit
10 Save Value  ENTER + 		SAVE SELECTION
11 Return to Main Display  ESC MENU 2x		Return to MAIN DISPLAY

Calculating 4-20mA Input

Sensor Type	20mA Set Point
Submersible	Range of sensor / Specific Gravity = 20mA (for inches)
Ultrasonic	Tank Height
Radar	Tank Height

Programming Relays

STEPS	DISPLAY	OPERATION
1 Main Display  ESC MENU 3 SEC		MAIN DISPLAY
2 Relay 1  ENTER		RELAY 1 Settings
3 Output  ENTER		OUTPUT MENU
4 Set Relay Value  ENTER 2 SEC		Press  or  to change digit Press ENTER to advance to next digit
5 Save Value  ENTER + 		Save Selection and advance to Hysterisis
6 Set Hysterisis  ENTER		Hysterisis Settings
7 Save Value  ENTER 2 SEC		Press  or  to change digit Press ENTER to advance to next digit
8 Return to Main Display  ENTER		Save Selection
8 Return to Main Display  ESC MENU 2x		Press  Button (2x) (Home Screen Current Level Reading appears on display)

Pump Controller with Dual-Pump Alternation

The ITC 450 can be used as an affordable pump controller when combined with a continuous level transmitter. One of the most common pump control applications is shown below —controlling and alternating two pumps.

The goal is to control the level between 1000 and 6000 gallons. The main pump turns on when the level reaches 6000 gallons and pumps down to 1000 gallons and then shuts the pump off. The next cycle, the backup pump turns on at 6000 gallons and shuts off at 1000 gallons. If at any time the active pump can't keep the level below 7000 gallons, the other pump would come on as well.

Pump Alternation Control Operation

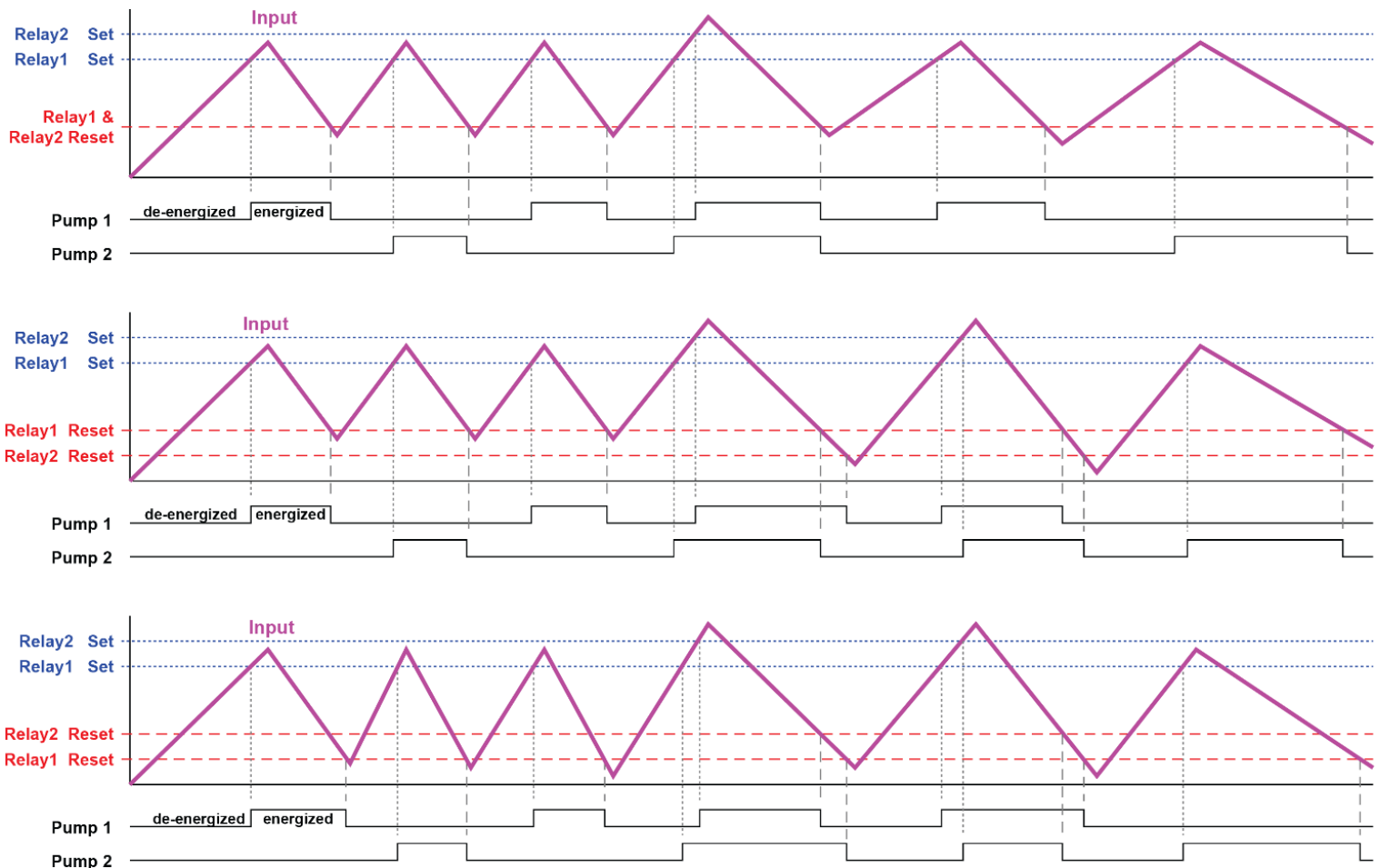

LEDs indicate the relay status

Pump Controller with Dual-Pump Alternation

Relay #1 turns the main pump on at 6000 gallons and turns it off at 1000 gallons.

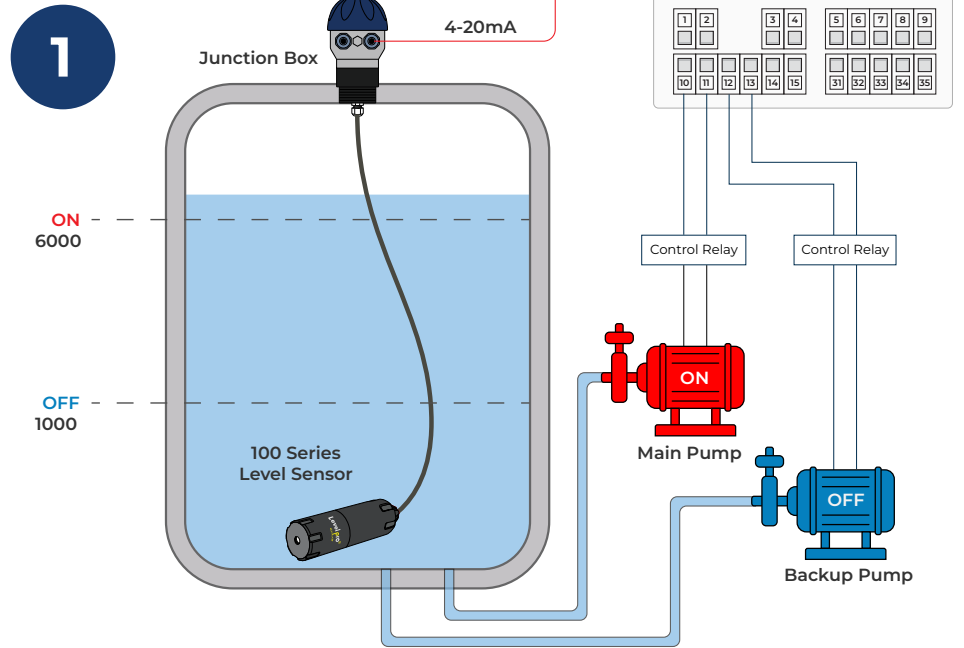

With the Pump Alternation feature activated, the next time the level reaches 6000 gallons, relay #2 starts the backup pump.

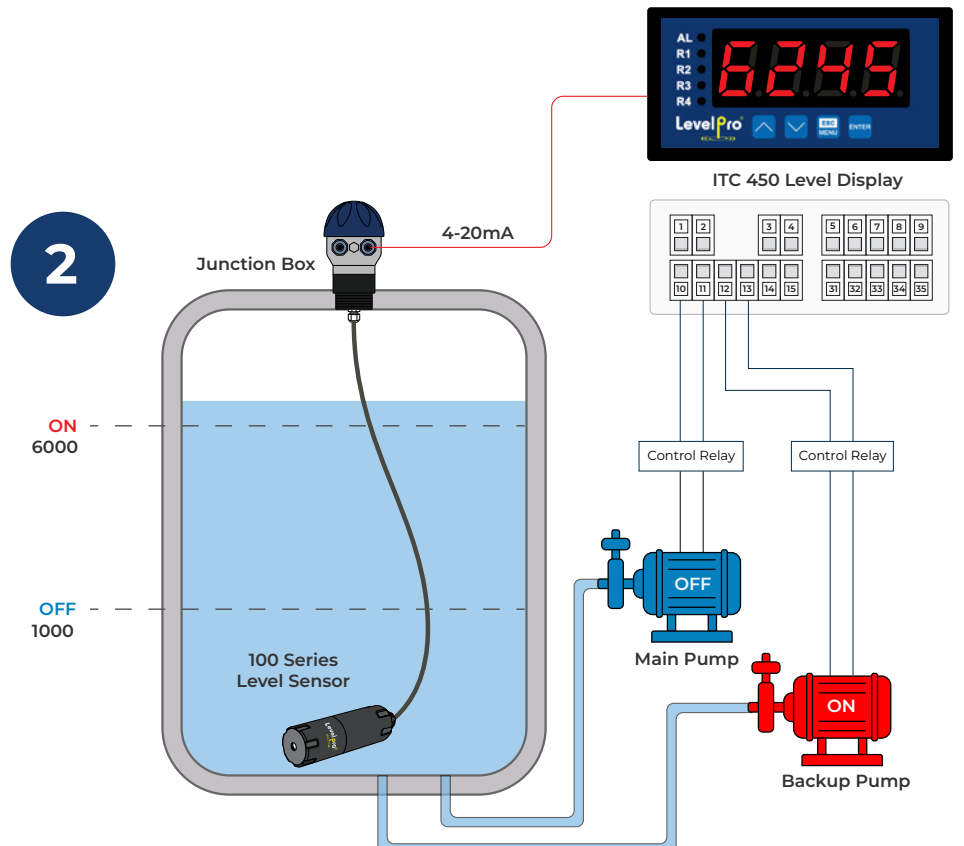

Pump Controller with Dual-Pump Alternation

If the pump is not able to keep up, and the level reaches 7000 gallons, the other relay will start the inactive pump as well

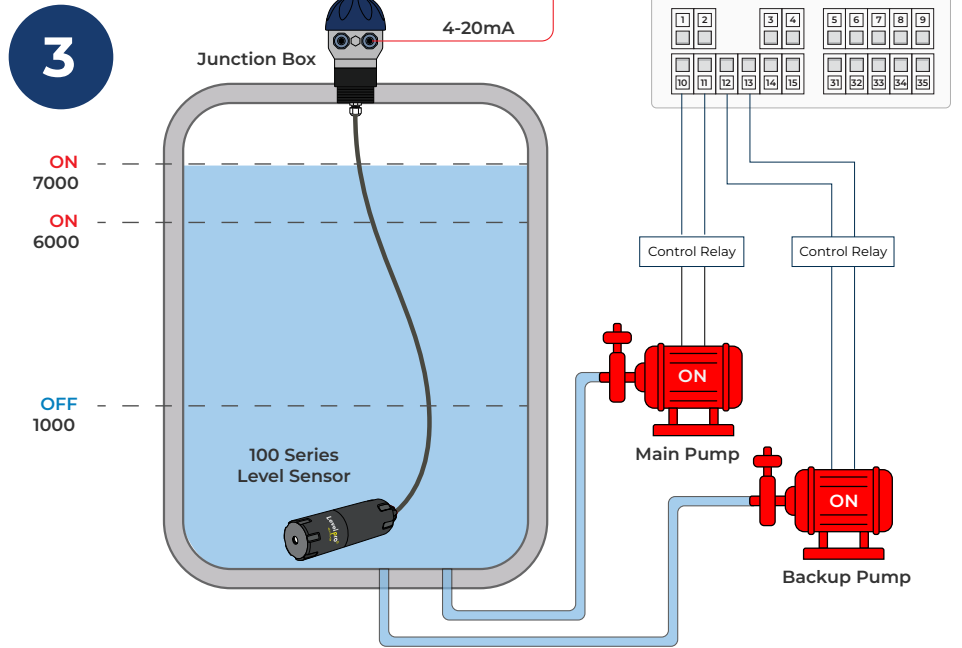

When the level falls below 1000 gallons, both pumps will turn off.

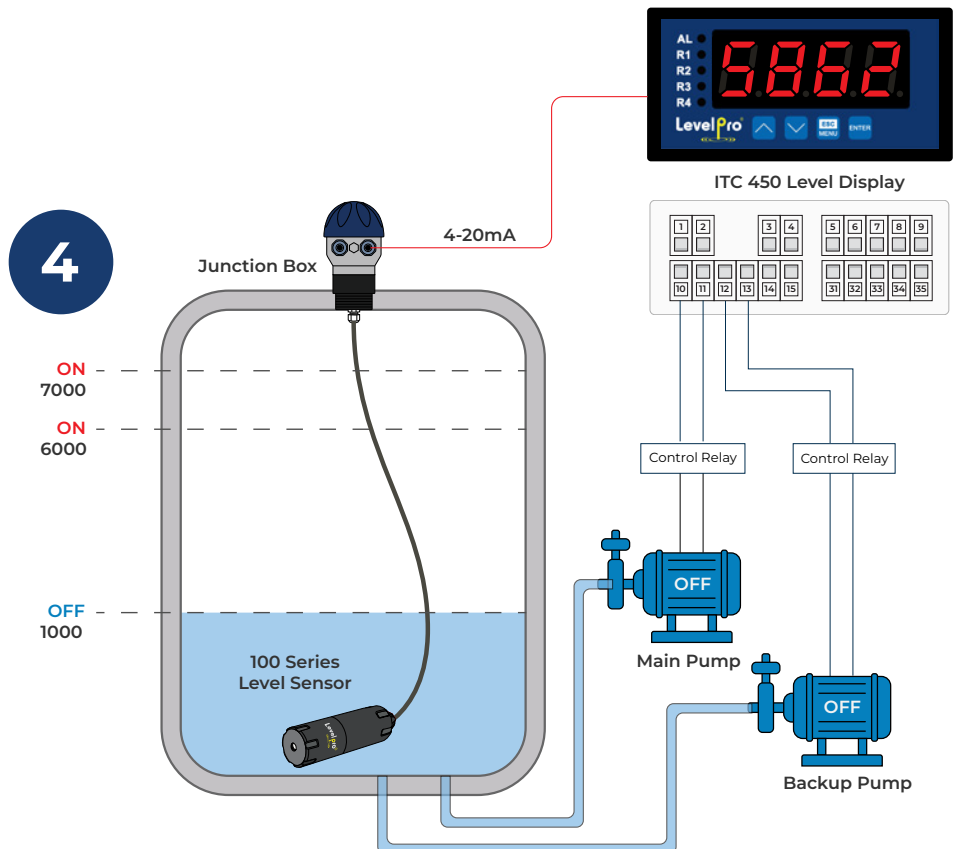

RS485 Modbus Programming

11. THE MODBUS PROTOCOL HANDLING

Transmission parameters: 1 start bit, 8 data bits, 1 or 2 stop bit (2 bits are send, 1 and 2 bits are accepted when receive), no parity control
 Baud rate: selectable from: 1200 to 115200 bits/second
 Transmission protocol: MODBUS RTU compatible

The device parameters and display value are available via RS-485 interface, as HOLDING-type registers (numeric values are given in U2 code) of Modbus RTU protocol. The registers (or groups of the registers) can be read by 03h function, and wrote by 06h (single registers) or 10h (group of the registers) accordingly to Modbus RTU specification. Maximum group size for 03h and 10h functions can not exceeds 16 registers (for single frame).



The device interprets the broadcast messages, but then do not sends the answers.

11.1. LIST OF REGISTERS

Register	Write	Range	Register description
01h	No	-999 ÷ 9999	Measurement value (no decimal point)
02h	No	0h, A0h, 60h	The status of the current measurement; 0h - data valid; A0h - top border of the measurement range is exceeded; 60h - bottom border of the measurement range is exceeded;
03h	Yes	0 ÷ 3	" Pnt " parameter in " InPt " menu (decimal point position) 0 - " 0"; 1 - " 0.0"; 2 - " 0.00"; 3 - "0.000"
04h	Yes	see descr.	State of the relays and alarm LED (binary format) (1 - on, 0 - off): 00000000 000e00ba a - relay R1; b - relay R2; e - alarm LED; If written, only a , b bits are important (others are ignored) these bits allows user to control the relays via RS-485 interface
05h ¹	Yes	0h ÷ 1800h	State of active current output, expressed in 1/256 mA units – it means that high byte express integer part, and low byte fractional part of desired output current.
	Yes	2CCh÷1800h	State of passive current output, expressed in 1/256 mA units – it means that high byte express integer part, and low byte fractional part of desired output current.
	Yes	0h ÷ 1600h	State of active voltage output, expressed in 1/512 V units – it means that high byte express integer part, and low byte fractional part of desired output voltage.
06h	No	-999 ÷ 9999	Peak (drop) value (no decimal point)
10h	Yes	0 ÷ 5	" tyPE " parameter in " InPt " menu (nominal input range). 0 - 0-20 mA range; 1 - 4-20 mA range; 2 - 0-10 V range; 3 - 2-10 V range; 4 - 0-5 V range; 5 - 1-5 V range
11h	Yes	0 ÷ 5	" CHAR " parameter in " InPt " menu (characteristic type) 0 - linear; 1 - square; 2 - square root; 3 - user defined; 4 - volume characteristics of a cylindrical tank in the vertical position; 5 - volume characteristics of a cylindrical tank in the horizontal position
12h	Yes	0 ÷ 5	" Filt " parameter in " InPt " menu (measurement filtering rate)

RS485 Modbus Programming

Register	Write	Range	Register description
13h	Yes	0 ÷ 3	"Pnt" parameter in "InPt" menu (the copy of 03h register, decimal point position) 0 - " 0"; 1 - " 0.0"; 2 - " 0.00"; 3 - "0.000"
14h	Yes	-999 ÷ 9999	"Lo C" parameter in "InPt" menu, no decimal point included
15h	Yes	-999 ÷ 9999	"Hi C" parameter in "InPt" menu, no decimal point included
16h	Yes	0 ÷ 999	"Lo r" parameter in "InPt" menu, in 0.1%
17h	Yes	0 ÷ 199	"Hi r" parameter in "InPt" menu, in 0.1%
19h	Yes	0 ÷ 9999	"t h1" parameter in "InPt" menu, no decimal point included
1Ah	Yes	0 ÷ 9999	"t h2" parameter in "InPt" menu, no decimal point included
1Bh	Yes	0 ÷ 9999	"t h3" parameter in "InPt" menu, no decimal point included
1Ch	Yes	0 ÷ 9999	"t d" parameter in "InPt" menu, no decimal point included
1Dh	Yes	0 ÷ 9999	"t Sn" parameter in "InPt" menu, no decimal point included
1Eh	Yes	0 ÷ 9999	"t Sh" parameter in "InPt" menu, no decimal point included
20h ²	Yes	0 ÷ 199	Device address
21h	No	21F0h	Device identification code (ID)
22h ³	Yes	0 ÷ 7	"bAud" parameter in "rS" menu (baud rate); 0 - 1200 baud; 1 - 2400 baud; 2 - 4800 baud; 3 - 9600 baud; 4 - 19200 baud; 5 - 38400 baud; 6 - 57600 baud; 7 - 115200 baud
23h ⁴	Yes	0 ÷ 1	"mbAc" parameter in "rS" menu (permission to write registers via RS-485 interface); 0 - write denied ; 1 - write allowed
24h	Yes	see descr.	Parameters of "SECU" menu (binary format (0 - „oFF", 1 - „on")): bit 0 - "A r1" parameter; bit 1 - "A r2" parameter
25h	Yes	0 ÷ 5	"rESP" parameter in "rS" menu (additional response delay); 0 - no additional delay; 1 - "10c" option; 2 - "20c" option; 3 - "50c" option; 4 - "100c" option; 5 - "200c" option;
27h	Yes	0 ÷ 99	"mbtO" parameter in "rS" menu (maximum delay between received frames); 0 - no delay checking; 1 ÷ 99 - maximum delay expressed in seconds
2Dh	Yes	1 ÷ 8	"bri" parameter (display brightness); 1 - the lowest brightness; 8 - the highest brightness
2Fh	Yes	0 ÷ 1	"Edit" parameter (numerical parameters edit mode); 0 - „dig" mode; 1 - „SLid" mode
30h	Yes	-999 ÷ 9999	"SEtP" parameter in "rEL1" menu, no decimal point included
31h	Yes	-999 ÷ 999	"HySt" parameter in "rEL1" menu, no decimal point included
32h	Yes	0 ÷ 5	"modE" parameter in "rEL1" menu: 0 - "noAC" mode; 1 - "on" mode; 2 - "oFF" mode; 3 - "in" mode; 4 - "out" mode; 5 - "modb" mode
33h	Yes	0 ÷ 999	"t on" parameter in "rEL1" menu, expressed in tenth of seconds or tenth of minutes depend on "unit" parameter - register no. 35h)

RS485 Modbus Programming

Register	Write	Range	Register description
34h	Yes	0 ÷ 999	“toFF” parameter in “rEL1” menu, expressed in tenth of seconds or tenth of minutes depend on “unit” parameter - register no. 35h)
35h	Yes	0 ÷ 1	“unit” parameter in “rEL1” menu: 0 - seconds; 1 - minutes
36h	Yes	0 ÷ 2	“AL” parameter in “rEL1” menu: 0 - no changes; 1 - on; 2 - off
37h	Yes	-999 ÷ 9999	“SEt2” parameter in “rEL1” menu, no decimal point included
38h	Yes	-999 ÷ 9999	“SEtP” parameter in “rEL2” menu, no decimal point included
39h	Yes	-999 ÷ 999	“HySt” parameter in “rEL2” menu, no decimal point included
3Ah	Yes	0 ÷ 5	“modE” parameter in “rEL2” menu: 0 - “noAC” mode; 1 - “on” mode; 2 - “oFF” mode; 3 - “in” mode; 4 - “out” mode; 5 - “modb” mode
3Bh	Yes	0 ÷ 999	“t on” parameter in “rEL2” menu, expressed in tenth of seconds or tenth of minutes depend on “unit” parameter - register no. 3Dh)
3Ch	Yes	0 ÷ 999	“toFF” parameter in “rEL2” menu, expressed in tenth of seconds or tenth of minutes depend on “unit” parameter - register no. 3Dh)
3Dh	Yes	0 ÷ 1	“unit” parameter in “rEL2” menu: 0 - seconds; 1 - minutes
3Eh	Yes	0 ÷ 2	“AL” parameter in “rEL2” menu: 0 - no changes; 1 - on; 2 - off
3Fh	Yes	-999 ÷ 9999	“SEt2” parameter in “rEL2” menu, no decimal point included
50h	Yes	0 ÷ 1	“modE” parameter in “HOLd” menu (type of detected changes): 0 - peaks; 1 - drops
51h	Yes	0 ÷ 9999	“PEA” parameter in “HOLd” menu (minimum detectable change, no decimal point included)
52h	Yes	0 ÷ 199	“timE” parameter in “HOLd” menu, maximum peaks' (or drops') display time expressed in seconds
53h	Yes	0 ÷ 1	“HdiS” parameter in “HOLd” menu: 0 - “rEAL” mode ; 1 - “HOLd” mode
54h	Yes	0 ÷ 1	“H r1” parameter in “HOLd” menu : 0 - “rEAL” mode ; 1 - “HOLd” mode
55h	Yes	0 ÷ 1	“H r2” parameter in “HOLd” menu: 0 - “rEAL” mode ; 1 - “HOLd” mode
58h ¹	Yes	0 ÷ 1	“HOut” parameter in “HOLd” menu: 0 - “rEAL” mode ; 1 - “HOLd” mode
70h ⁵	Yes	-999 ÷ 1999	The value of „X” coordinate of point no. 1 of the user defined characteristic, expressed in 0.1%
71h ⁵	Yes	-999 ÷ 9999	The value of „Y” coordinate of point no. 1 of the user defined characteristic, no decimal point included
72h ⁵ ÷ 95h ⁵			Further pairs of „X” - „Y” coordinates of points no. 2 ÷ 19 of the user defined characteristic

RS485 Modbus Programming

Register	Write	Range	Register description
96h ⁵	Yes	-999 ÷ 1999	The value of „X” coordinate of point no. 20 of the user defined characteristic, expressed in 0.1%
97h ⁵	Yes	-999 ÷ 9999	The value of „Y” coordinate of point no. 20 of the user defined characteristic, no decimal point included
A0h ¹	Yes	0 ÷ 3	“Omod” parameter in “OUTP” menu (active current output mode) 0 - current output disabled; 1 - current output enabled with 4÷20mA mode; 2 - current output enabled with 0÷20mA mode; 3 - current output controlled via RS-485 interface
	Yes	0 ÷ 2	“Omod” parameter in “OUTP” menu (passive current output mode) 0 - current output disabled; 1 - current output enabled with 4÷20mA mode; 2 - current output controlled via RS-485 interface
	Yes	0 ÷ 5	“Omod” parameter in “OUTP” menu (active voltage output mode) 0 - voltage output disabled; 1 - voltage output enabled with 0÷5V mode; 2 - voltage output enabled with 1÷5V mode; 3 - voltage output enabled with 0÷10V mode; 4 - voltage output enabled with 2÷10V mode; 5 - voltage output controlled via RS-485 interface
A1h ¹	Yes	-999 ÷ 9999	“OUTL” parameter in “OUTP” menu, no decimal point included
A2h ¹	Yes	-999 ÷ 9999	“OUTH” parameter in “OUTP” menu, no decimal point included
A3h ¹	Yes	0 ÷ 999	“Lo r” parameter in “OUTP” menu, for active current output and active voltage output, expressed in 0.1%
	Yes	0 ÷ 299	“Lo r” parameter in “OUTP” menu for passive current output, expressed in 0.1%
A4h ¹	Yes	0 ÷ 199	“Hi r” parameter in “OUTP” menu for active and passive current output, expressed in 0.1%
	Yes	0 ÷ 99	“Hi r” parameter in “OUTP” menu for active voltage output, expressed in 0.1%
A5h ¹	Yes	0 ÷ 3	“AL” parameter in “OUTP” menu (active current output value on critical exception): 0 - no change; 1 - 22.1 mA; 2 - 3.4 mA; 3 - 0 mA
	Yes	0 ÷ 2	“AL” parameter in “OUTP” menu (passive current output value on critical exception): 0 - no change; 1 - 22.1 mA; 2 - 3.4 mA
	Yes	0 ÷ 5	“AL” parameter in “OUTP” menu (active voltage output value on critical exception): 0 - no change; 1 - 11 V; 2 - 5.5; 3 - 1.2 V; 4 - 0.6 V; 5 - 0 V

- 1 - these registers are active only if device is equipped with current or voltage output
- 2 - after writing to register no 20h the device responds with an “old” address in the message.
- 3 - after writing to register no 22h the device responds with the new baud rate.
- 4 - the value of the “mbAc” parameter is also connected to write to this register, so it is possible to block a writes, but impossible to unblock writes via RS-485 interface, The unblocking of the writes is possible from menu level only.
- 5 - the pairs of „X-Y” coordinates may be defined for any free point. The pair is “free” (it means that particular point is not defined) if „X” coordinate of this point is equal 8000h. After writing both X and Y coordinate the point is defined and used in calculation of result. The coordinates of any point can be changed at any time.

RS485 Modbus Programming

11.2. TRANSMISSION ERRORS DESCRIPTION

If an error occurs while write or read of single register, then the device sends an error code according to Modbus RTU specifications (example message no 1).

Error codes:

01h - illegal function (only functions 03h, 06h and 10h are available),

02h - illegal register address

03h - illegal data value

08h - no write permission (see: “**mbAc**” parameter)

A0h - exceed of upper border of input range

60h - exceed of lower border of input range

A0h and 60h codes can appear only during reg. 01h is reading by 03h function (read of a single register).

11.3. EXAMPLES OF QUERY/ANSWER FRAMES

Examples apply for device with address 1. All values are represent hexadecimal.

Field description:

ADDR	Device address on modbus network
FUNC	Function code
REG H,L	Starting address (address of first register to read/write, Hi and Lo byte)
COUNT H,L	No. of registers to read/write (Hi and Lo byte)
BYTE C	Data byte count in answer frame
DATA H,L	Data byte (Hi and Lo byte)
CRC L,H	CRC error check (Hi and Lo byte)

1. Read of the displayed value (measurement), SRP-N118 device address = 01h:

ADDR	FUNC	REG H,L		COUNT H,L		CRC L,H	
01	03	00	01	00	01	D5	CA

a) The answer (we assume that the measure result is not out of range):

ADDR	FUNC	BYTE C	DATA H,L		CRC L,H	
01	03	02	00	FF	F8	04

DATA H, L - displayed value = 255, no decimal point.
Decimal point position can be read from reg. 03h.

RS485 Modbus Programming

b) The answer (if an error occur):

ADDR	FUNC	ERROR	CRC L,H	
01	83	60	41	18

ERROR - error code = 60h, bottom border of the measurement range is exceeded

2. Read of device ID code

ADDR	FUNC	REG H,L		COUNT H,L		CRC L,H	
01	03	00	21	00	01	D4	00

The answer:

ADDR	FUNC	BYTE C	DATA H,L		CRC L,H	
01	03	02	21	F0	A0	50

DATA - identification code (21F0h)

3. Change of the device address from 1 to 2 (write to reg. 20h)

ADDR	FUNC	REG H,L		DATA H,L		CRC L,H	
01	06	00	20	00	02	09	C1

DATA H - 0

DATA L - new device address (2)

The answer (the same as the message):

ADDR	FUNC	REG H,L		DATA H,L		CRC L,H	
01	06	00	20	00	02	09	C1

4. Change of baud rate of all devices connected to the net (BROADCAST message).

ADDR	FUNC	REG H,L		COUNT H,L		CRC L,H	
00	06	00	22	00	04	29	D2

DATA H - 0

DATA L - 4, new baud rate 19200 baud



Device do not reply to BROADCAST-type messages.

RS485 Modbus Programming

5. Read of the registers 1, 2 and 3 in one message (example of reading a number of registries in one frame):

ADDR	FUNC	REG H,L		COUNT H,L		CRC L,H	
01	03	00	01	00	03	54	0B

COUNT L - the count of being read registers (max.16)

The answer:

ADDR	FUNC	BYTE C	DATA H1,L1		DATA H2,L2		DATA H3,L3		CRC L,H	
01	03	06	00	0A	00	00	00	01	78	B4

DATA H1, L1 - reg. 01h (10 - displayed value "1.0"),

DATA H2, L2 - reg. 02h (0 - no errors),,

DATA H3, L3 - reg. 03h (1 - decimal point position " 0.0").



There is no full implementation of the Modbus Protocol in the device. The functions presented above are available only.

RS485 Modbus Programming

12. DEFAULT AND USER'S SETTINGS LIST

<i>Parameter</i>	<i>Description</i>	<i>Default value</i>	<i>User's value</i>	<i>Desc. page</i>
Parameters of relay R1 operation ("rEL1" menu)				
SEtP	Relay R1 threshold	20.0		29
SEt2	Relay R1 second threshold	40.0		29
HYSt	Hysteresis of relay R1	0.0		29
modE	Operation mode of relay R1	on		29
t on	Turn on delay of relay R1	0.0		30
toFF	Turn off delay of relay R1	0.0		30
unit	Unit of "t on", "toFF" parameters of relay R1	SEC		30
AL	Reaction for critical situation of relay R1	oFF		30
Parameters of relay R2 operation ("rEL2" menu)				
SEtP	Relay R2 threshold	40.0		29
SEt2	Relay R2 second threshold	60.0		29
HYSt	Hysteresis of relay R2	0.0		29
modE	Operation mode of relay R2	on		29
t on	Turn on delay of relay R2	0.0		30
toFF	Turn off delay of relay R2	0.0		30
unit	Unit of "t on", "toFF" parameters of relay R2	SEC		30
AL	Reaction for critical situation of relay R2	oFF		30
Configuration of measurement input ("inPt" menu)				
tYPE	Input mode	„4-20"		31
CHAr	Conversion characteristic mode	Lin		31
FiLt	Filtering ratio	0		31
Pnt	Decimal point position	0.0		31
Lo C	Minimum displayed value (for nominal range)	000.0		32
Hi C	Maximum displayed value (for nominal range)	100.0		32
t h1	Height (length) first part of the tank	00.00		32
t h2	Height (length) second part of the tank	00.00		32
t h3	Height (length) third part of the tank	00.00		32
t d	Tank diameter	00.01		32
t Sn	Distance between sensor and bottom of the tank	00.00		32
t Sh	Height of the sensor	20.00		32
Lo r	Extension of the bottom of the nominal input range	5.0 (%)		35

RS485 Modbus Programming

<i>Parameter</i>	<i>Description</i>	<i>Default value</i>	<i>User's value</i>	<i>Desc. page</i>
Hi r	Extension of the top of the nominal input range	5.0 (%)		35
Current output configuration ("OUTP" menu)				
Omod	Current output mode	„4-20" (mA)		37
OUTL	Display value for 4 mA current output	0.0		37
OUTH	Display value for 20 mA current output	100.0		37
Lo r	Extension of the bottom of the nominal output range	5.0 (%)		38
Hi r	Extension of the top of the nominal output range	5.0 (%)		38
AL	Current output value on critical exception	22.1 (mA)		38
Display parameters				
bri	Display brightness	bri6		38
Configuration of peaks detection function ("HOLd" menu)				
modE	Kind of detected changes	norm		39
PEA	Minimum detected change	0.0		39
timE	Maximum time of peak displaying	0.0		39
HdiS	The type of displayed value	HOLd		39
H r1	Source of relay R1, and LED R1 control	rEAL		39
H r2	Source of relay R2, and LED R2 control	rEAL		39
HOut	Source of current output control	rEAL		39
Settings of access to the configuration parameters ("SECu" menu)				
A r1	Permission to changes of relay R1 threshold without of the user password knowledge	on		39
A r2	Permission to changes of relay R2 threshold without of the user password knowledge	on		39
RS 485 interface configuration (menu "rS")				
Addr	Device address	0		40
bAud	Baud rate	9.6		40
mbAc	Permission to changes of configuration registers	on		40
mbtO	Maximum delay between received messages	0		40
rESP	Additional delay of answer transmission	Std		40
Configuration of numerical parameters edition				
Edit	Numerical parameters edit mode	dig		41