

MULTIDETEK₂



COMPACT GAS CHROMATOGRAPH FOR INDUSTRIAL AND LAB APPLICATIONS

With its plug and play philosophy and offering more features than ever, LDetek pushes further the possibilities with its chromatograph system. It offers a robust and cost-effective solution for the industrial and laboratory markets.

Based on the LDetek high performance detection technology, this stand-alone Gas Chromatograph is a flexible and customized platform providing the best solution for any type of gas analysis.



FEATURES & DESIGN:

- One chassis configuration (6U Rackmount)
- Multichannels
- Multimethods
- Multidetectors
- Up to 6 isothermal or 3 programmable oven combination
- Up to 5 high purity proportional diaphragm valves (carrier-sample)
- Easy maintenance with its slide out design and front opening door
- ppt, ppb, ppm and % gas analysis
- Built in PC with 8.4" touch screen LCD & user-friendly interface
- Up to 10 high performance diaphragm valves
- Ethernet connectivity for remote control
- Integrated compact purifier with real end of life monitoring
- Serial/Profibus/Modbus communication protocols
- Fast parallel chromatography
- Multi heated zones to avoid cold points
- Purged & real time monitored zones for hazardous gases
- Multi sample injection techniques

BUILT IN PC WITH 8.4" TOUCHSCREEN LCD & USER-FRIENDLY INTERFACE

The Multidetek-2 offers an easy and complete interface working on Windows 7 embedded. With its 8.4" clear LCD touch screen, it allows the operator to navigate easily through the different menus. Moreover, the system includes an Ethernet port for remote control.

COMPACT AND RACK MOUNT DESIGN

With a 6U rack mount chassis, this compact GC design can be installed in many different areas going from industrial to laboratory. It can be installed where available space is limited as well as transportable unit.

PUSH BUTTON

Friendly push button to open the front door.

KEYBOARD OPERATION

Beside the touch screen panel PC, each system is provided with a USB keyboard to operate the user interface.

USB CONNECTOR / EXTERNAL STORAGE

Data can be stored on an external drive and/or move to any other system or computer to be visualized at any time. This USB port is also available for software update or any other windows 7 interfacing.



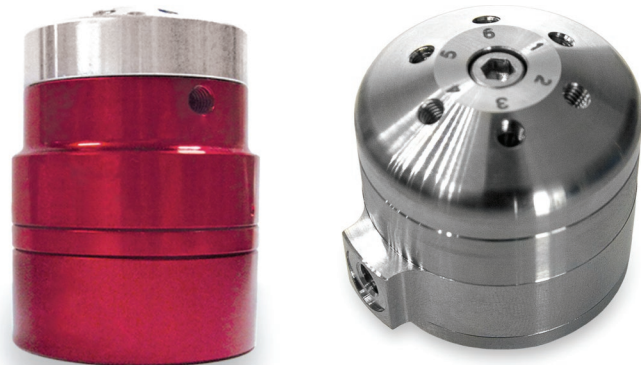

HIGH PERFORMANCE DIAPHRAGM VALVE

The use of high performance diaphragm valve bring outstanding measurement performance. A longer lifetime and better performance on common GC techniques are achieved. They also allow new analysis methods. 1/16" and/or 1/32" diaphragm valve connections, tubing and columns are used. Using 1/32" can reduce carrier gas consumption reducing operation cost. Consult LDetek application notes for more information.

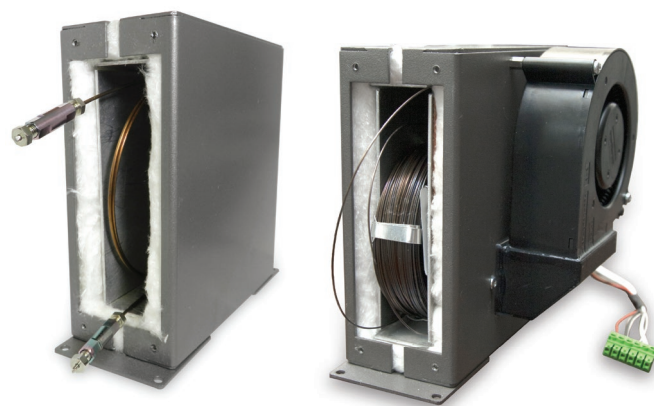

ISOTHERMAL AND/OR PROGRAMMABLE OVENS FOR ANY TYPE OF COLUMNS

The oven design can accept any type of packed, micro packed and plot columns. It offers a very stable and quick temperature controllable to proceed to high temperature column regeneration in the unit. With its multiple programmable ovens, more applications are feasible with reduced analysis time.

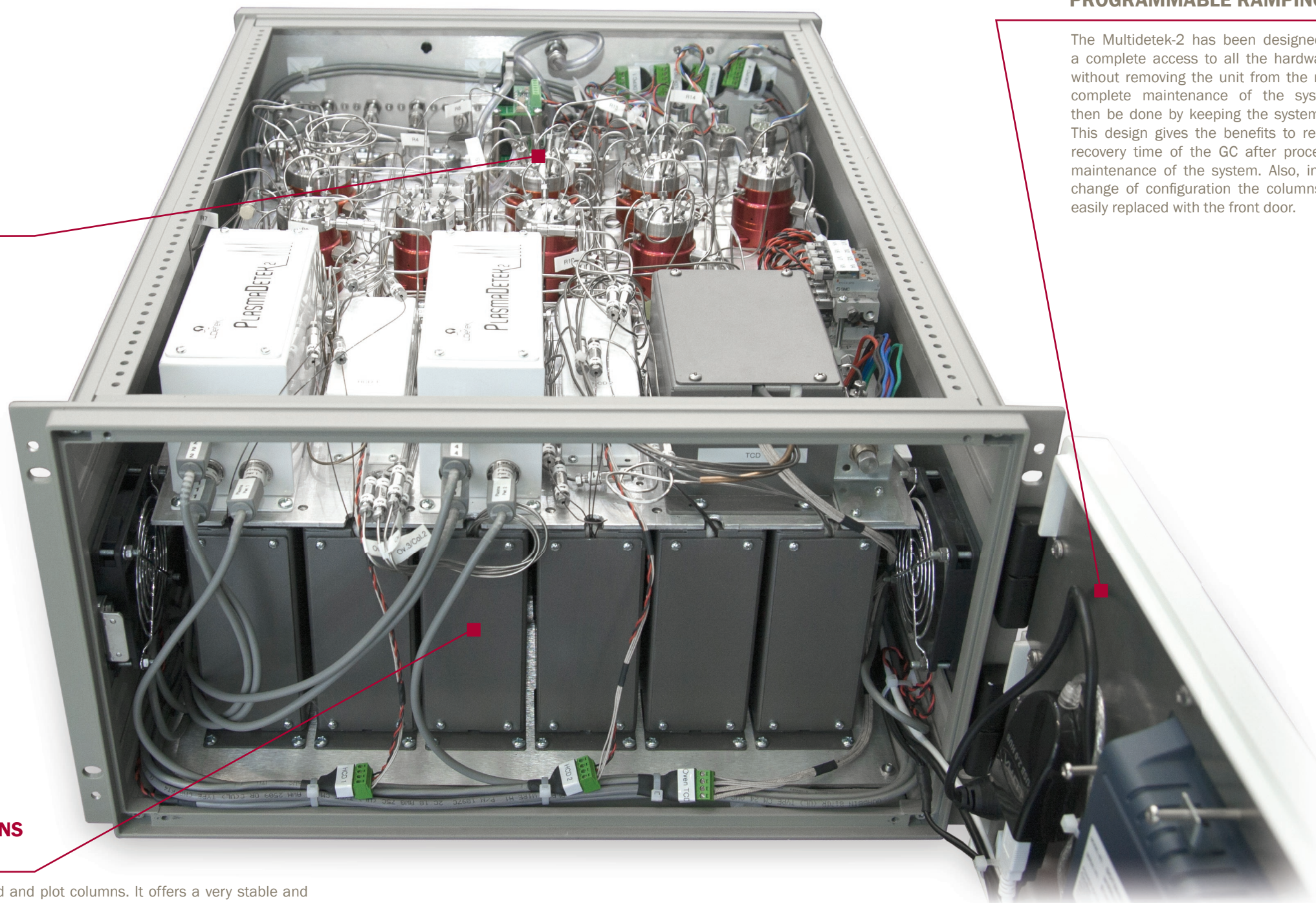

FRONT ACCESS TO THE ISOTHERMAL AND/OR PROGRAMMABLE RAMPING OVENS

The Multidetek-2 has been designed to give a complete access to all the hardware parts without removing the unit from the rack. The complete maintenance of the system can then be done by keeping the system on gas. This design gives the benefits to reduce the recovery time of the GC after proceeding to maintenance of the system. Also, in case of change of configuration the columns can be easily replaced with the front door.

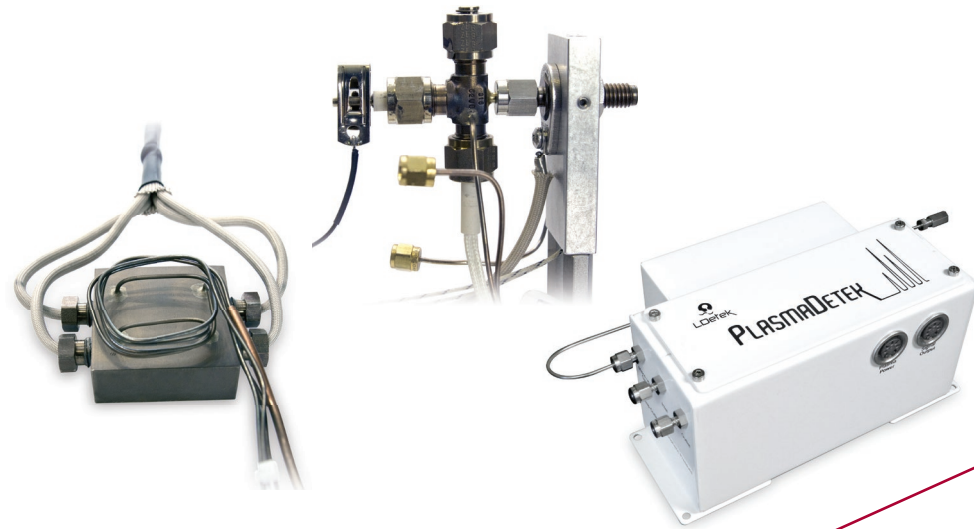

3 DETECTORS COMPATIBLE

Three detectors can be installed in the same chassis with a combination of any PED, TCD and FID detector. It gives more flexibility and the possibility to measure more components with one system.

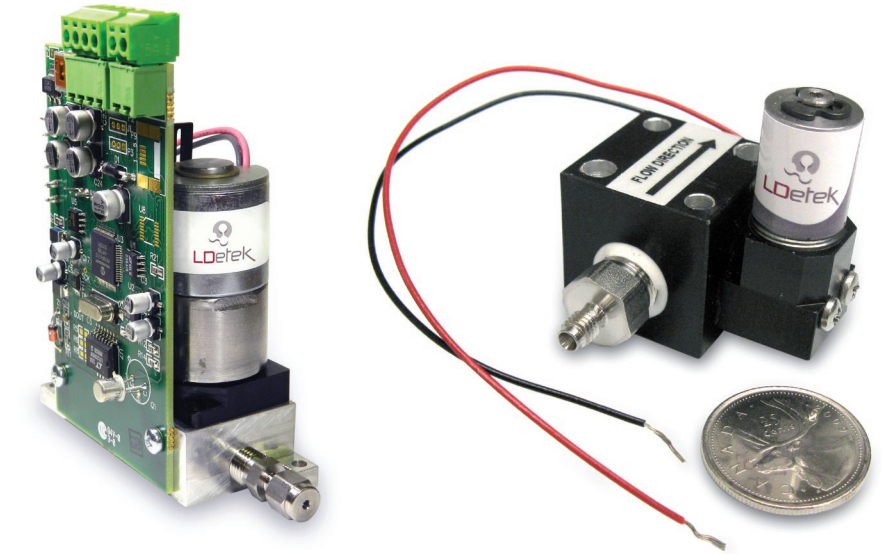

ELECTRONIC FLOW CONTROLLER

With its electronic flow controller, the MultiDetek 2 offers the possibility to have automatic flow adjustment. LDetek has developed its own valve design offering low dead volume and fast response time. A manual version is also available.

INPUTS/OUTPUTS INTERFACE

Many inputs/outputs are available to be able to communicate and receive information from the device: Digital outputs for device status, serial communication (RS-232/485, Profibus, Modbus), analog inputs to acquire external device signal, 4-20 mA output for results information, ethernet for remote control, USB port.



EASY MAINTENANCE WITH ITS SLIDE OUT DESIGN

The same approach has been done on the back side of the unit. Other critical components can be reached from the back for maintenance purpose using its pull out rail system. Again, it gives the benefit to perform system maintenance with reduced recovery time without removing the gas lines from the unit.

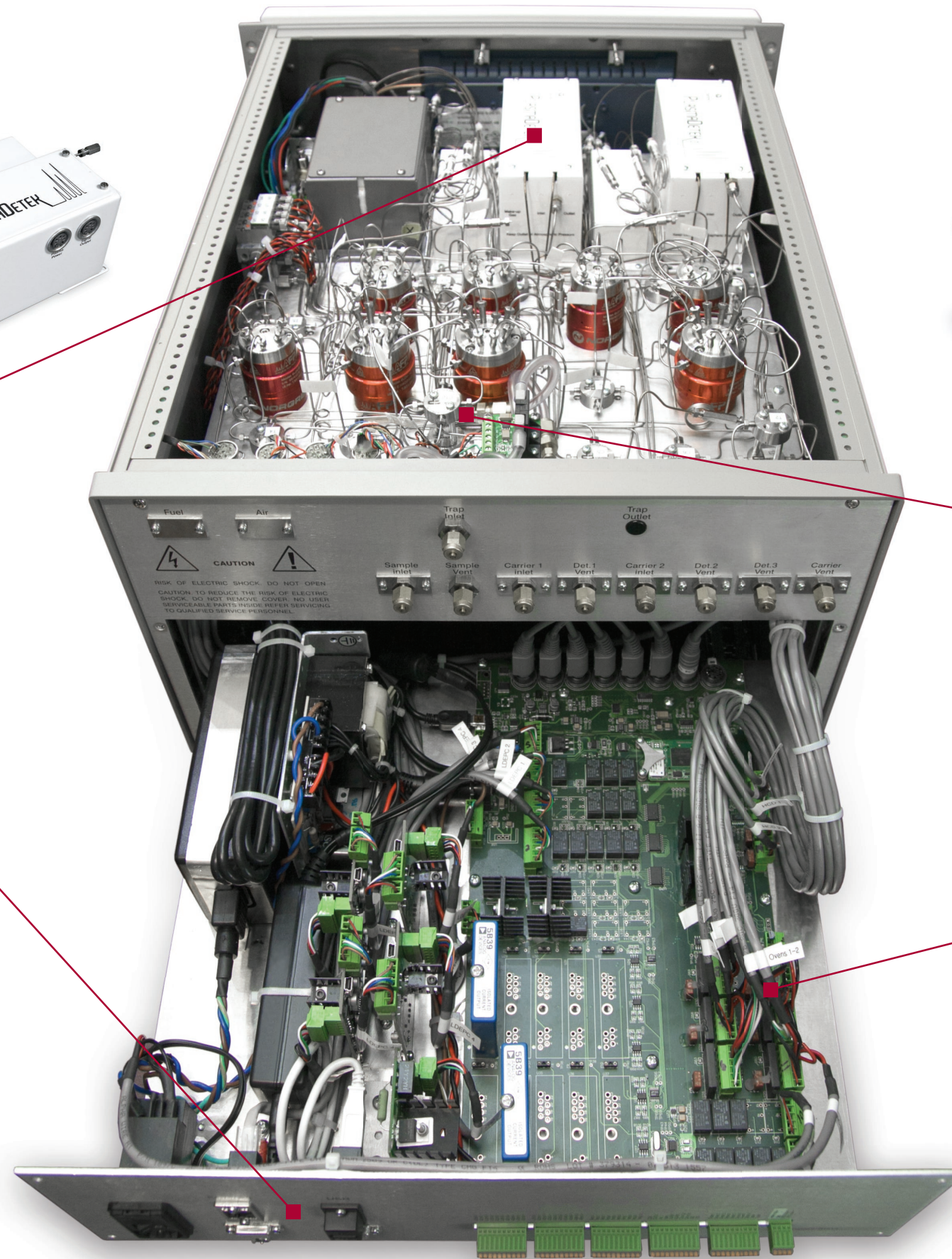

Gas Chromatography Software

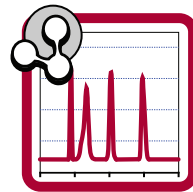

LDchroma gas chromatography software for process/lab analyses

LDchroma software is used to control the internal components of the MultiDetek2 gas chromatograph and make the bridge with the surrounding industrial environment and the rest of the world offering a full remote control of your instrument.

What it controls internally?

- ▶ Temperatures, flows, valves, detectors, A/D inputs, A/D outputs, streams selection, calibration, alarms

What kind of intelligence it offers?

- ▶ Maintenance interval/cost and lifetime of components
- ▶ A choice across a multiple peak detection algorithms is automatically selected
- ▶ Secure, administrator-controlled user access and permissions to ensure data integrity
- ▶ Simplified run creation, including sequence, methods and reports

How it communicates with the external world?

LDchroma can talk with automated systems using Modbus, Profibus or Profinet (other protocols available on request) depending on the requirements. It is generally used to send/receive any type of commands and results with the plant.



For the remote control of the LDchroma software, the Ethernet connection also allows the use of any type of remote control software compatible with Windows. It becomes easy to operate your gas analyser at distance and also select your desired method/stream and even calibrate it.



LDreport for data management

LDreport can perform many different types of report format. You can customize the analysis certificate as you desire. LDreport can save in multiple format as pdf, excel and html. You can also print it on your local printer or any printer connected on the network. Adding company logo and other custom information can be put on the report template as well.

LDreport is also used as database where you have access to all chromatograms and results from your instrument. It is very useful to compare results, trends, chromatograms by selecting any period range. LDreport is well designed to simplified backup, searching, and trending of chromatography data.

HOW OUR SOLUTION MAKES YOUR LIFE EASIER



ROBUSTNESS & MODULARITY

Nothing better than showing our own gas chromatograph to demonstrate a symbol of robust and modular design offering all the gas analysis possibilities inside one compact instrument. Your application has changed, and your instrument must be re-configured? No problem! Our modularity design makes it easy to readapt the instrument to your actual need. Design by experts, for leaders.



REMOTE ACCESS

Remote connection through network allows our experts to access your instruments for quick support. Our platform infrastructure allows to access the internal database of the instrument to know all the historic events. Years of information, access in a second.



WORLDWIDE HIGH SKILL TECHNICAL RESSOURCES

Wherever you are located, we have high skill experts ready to help you. Our training program within our organization makes our technical resources always up to date and ready.



WARRANTY & TRADE IN PROGRAMS

Extended warranty programs are there to make your life easier. Our high value design product gives you a residual value at its end of life to trade with our latest technology available. Let us work for you!

HOW WE MEASURE CONFIDENCE



By having the demonstration of our ability to build robust solutions based on highly skilled involved employees and high quality criteria company philosophy. This is represented by long durability of our instruments being more than 11 years. At the end of this cycle, our company engagement is proud to open discussions to offer the residual value of your highly valuable analytical instrument in exchange for our latest technology device suitable for your application.

ASK US FOR OUR SERVICE AND WARRANTY PROGRAMS AVAILABLE

 Apply your residual value with our trade-in program with latest technology

FULL WARRANTY 18 MONTHS 

EXTENDED WARRANTY PROGRAM UP TO 10 YEARS 

MAINTENANCE PROGRAM EVERY 3-5 YEARS 



SPECIFICATIONS:

| | |
|--|---|
| DETECTOR TYPE | PED, TCD, FID |
| STANDARD FEATURES | <ul style="list-style-type: none"> • Manual or auto-ranging (user selectable) • Microprocessor controlled • Windows 7 embedded user-friendly interface • Ethernet port for remote control • Isothermal and/or programmable ramping ovens • Electronic flow control regulators for carrier & sample gases • 8.4" LCD large touch screen • Self diagnosis system with auto-resolve alarm • 4-20 mA isolated outputs • Alarm Historic • Digital system status output for remote monitoring (dry relay contact) • 2 alarms contact • High resolution Chromatogram output |
| OPTIONS | <ul style="list-style-type: none"> • Serial communication (RS232/485) / Profibus / Modbus / Ethernet • Compact purifier attached to the chassis for generating high purity carrier gas • Integrated stream selector system • Digital inputs for remote starting • Analog inputs for connecting external instruments • Remote control for stream selector (LDGSS) • Purged zones for hazardous gases • Heated zones to avoid cold points • Monitoring system for hazardous gases • Split/split less injector (can be heated) • Integrated dilution system |
| GAS CONNECTIONS | 1/8" or 1/4" VCR or compression fittings |
| CARRIER PRESSURE REQUIREMENTS | 100 PSIG |
| OPERATING TEMPERATURE | 10 °C to 45 °C |
| SUPPLY | 115 VAC, 50 – 60 Hz or 220 VAC, 50 – 60 Hz |
| POWER CONSUMPTION | Maximum 500W |
| REPEATABILITY | Three times the percentage of deviation (3*CV %) of each component has to be smaller than 5% on ten consecutive cycles |
| LDL | 3 times noise level |
| LOQ | 3 times LDL value |
| LONG TERM STABILITY & DRIFT | Three times the percentage of deviation (3*CV %) of each component has to be smaller than 10% for 8 hours |
| LINEARITY | For 5 points within the measuring range, the linear curve must have its R2 at a value between 0.998 and 1.00 |

CERTIFICATION:

CE In compliance with EMC directive 2004/108/EC, EN 61000-6-2:2005 for immunity & EN 61000-6-4:2007 for emissions.

DIMENSIONS:

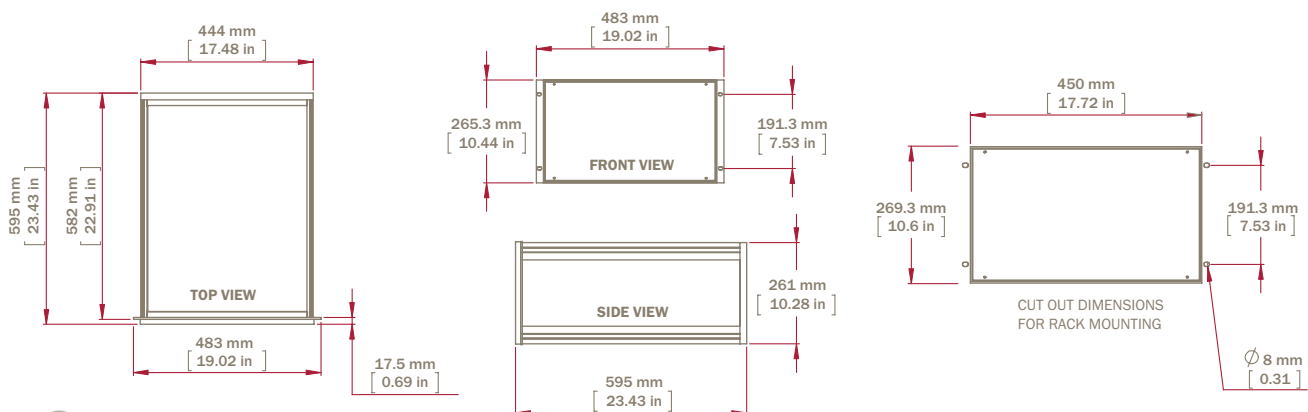

990 Monfette Est, Thetford Mines, (Qc), Canada, G6G 7K6
 Phone: 418 755-1319 • Fax: 418 755-1329 • info@ldetek.com

www.ldetek.com