

Sentinel Series LT

Tank | Sump Liquid Level Telemetry Monitoring Operating Manual



Corrosion-Free
Instrumentation Equipment

Table of Contents

Safety Information 03

Technological Progress 03

How It Works 03

Product Description 04

Technical Specifications - 100 Series Submersible Level Sensor 07

Technical Specifications - Sentinel Series LT 08

Technical Specifications - ITC-250B Series - Battery Powered Level Display 08

Technical Specifications - TVF Series - Level Process Display | Controller 08

Understanding Level Measurement 09

Getting Started 10

Calculating Max Range of Sensor 11

Correction Sensor Position 12

Sensor & Junction Box Installation 13

Sensor & Junction Box Wire Connection 14

Sentinel LT Install & Wire Connection 15

Sentinel Wire Connection 16

ITC-250B Display Wire Connection to Junction Box 17

ITC-250B Display Wire Connection 17

Wiring Diagram - Sentinel + Junction Box + Sensor 18

Wiring Diagram - Sentinel + Junction Box + Sensor + 250B Display 18

Wiring Diagram - Sentinel + Sensor + 250B Display 18

Wiring Diagram - Sentinel + Junction Box + Sensor + TVL Display 19

Wiring Diagram - Sentinel VU + Junction Box + Sensor 20

Wiring Diagram - Sentinel VU2 + Junction Box + Sensor (Dual Tank System) 20

Programing Display 21

Push Button Call-Out 22

Magnetic Call-Out 24

Battery Replacement 25

Application Details 26

Troubleshooting 26

Warranty, Returns & Limitations 29



**Corrosion-Free
Instrumentation Equipment**

Safety Information



Warning | Caution | Danger

Indicates a potential hazard. Failure to follow all warnings may lead to equipment damage, injury, or death



IMPORTANT!

Indicates situations or cases which, if not avoided, could result in damage or failure of the **Products** equipment.



Note | Technical Notes

Highlights additional information or detailed procedure.



Do Not Use Tools

Use of tool(s) may damage product beyond repair and potentially void product warranty.

- ❑ De-pressurize and vent system prior to installation or removal
- ❑ Confirm chemical compatibility before use
- ❑ DO NOT exceed maximum temperature or pressure specifications
- ❑ ALWAYS wear safety goggles or face-shield during installation and/or service
- ❑ DO NOT alter product construction

All operations described in this instruction manual have to be carried out only by trained personnel or an accredited person. Warranty and post warranty service must be exclusively carried out by the manufacturer.

Improper use, installation or set-up of the level meter can result in crashes in the application (overflowing of the tank or damage of system components).

The manufacturer is not responsible for improper use, losses of work caused by either direct or indirect damage, and for expenses incurred during installation or use of the level meter.

Technological Progress

The manufacturer reserves the right to revise, alter, or modify the flow meter to the most current technology without special prior notice. Further information about the latest updates and potential additions to these operating instructions are available from www.iconprocon.com

How It Works

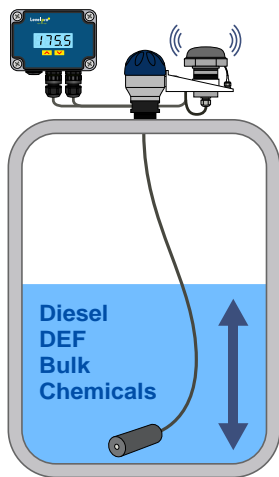

TANK | SUMP SENTINEL



Cellular Network

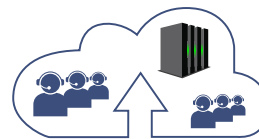

Sentinel 24/7 Online



Inventory Manager

Product Description

The **Sentinel Series** is a Battery Operated Remote Tank Level Monitoring system that delivers reliable daily measurements that are both scheduled and event driven. Remote tank level monitoring with the **Sentinel** is exceptionally flexible, eliminating the hassles of network infrastructures and Internet service. The Telemetry device connects via a wireless signal to local cellular networks and transmits Level, Alarms, Battery Status, Rate of Consumption History, Critical High or Low Level Alerts and Signal Strength, all of which are available through the **Sentinel** Cloud Based Website.

The **Sentinel** Remote Tank Level Monitoring unit provides you with important data readily at your fingertips on your Computer, Tablet or Smart Phone. The perfect solution for bulk chemical companies and large tank farms to save money on their logistics costs.

The **Sentinel Series** pairs well with our **100 Series Submersible Level Sensor** and our **ITC-250 Series** Battery Operated Liquid Level Display & Controller to provide you with the industry's most reliable complete tank level monitoring package. Mount your **Sentinel** unit directly to the top of the tank using our **LB50 Mounting Bracket**.

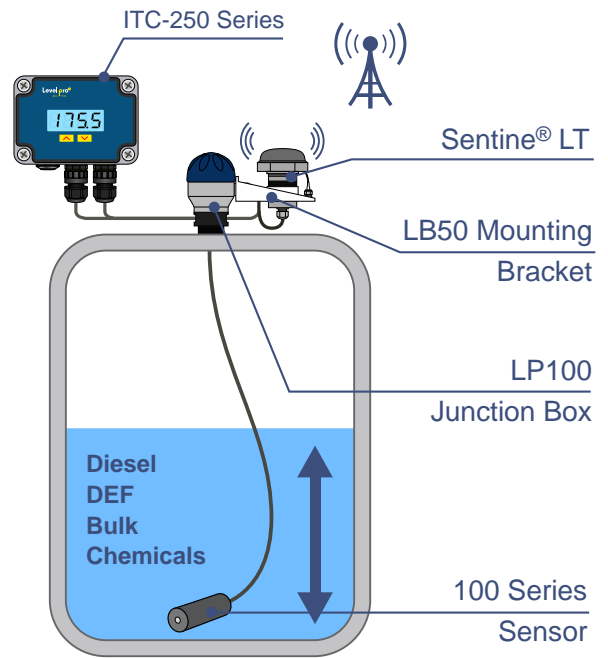

Sentinel Series LT | Telemetry Monitoring



Features

- ✔ Battery Operated - No Programming
- ✔ Remote Tank Monitoring via Cellular Networks
- ✔ E-mail / text Reporting Alarms
- ✔ 24/7 access to data through Cloud Based
- ✔ Sentinel 247TM Online
- ✔ Battery powered up to 5 years (3 calls/day)
- ✔ Variety of Trigger Points
- ✔ Mobile Ready Access
- ✔ Optional LB50 Mounting Bracker

LB50 Mounting Bracket



Features

- ✔ 2" NPT Connection
- ✔ Securely Holds Sentinel Series Telemetry Tank Monitor
- ✔ Perfect for PLF Series Point Level Switches
- ✔ Junction Box or Wall Mounting
- ✔ All Plastic Corrosion Resistant Design

100 Series Submersible Level Sensor



The **100 Series** Transmitter is designed for Continuous Level Measurement of Aggressive Liquid Media

Features

- ✔ Battery Operated - No Programming
- ✔ Remote Tank Monitoring via Cellular Networks
- ✔ E-mail / text Reporting Alarms
- ✔ 24/7 access to data through Cloud Based
- ✔ Sentinel 247TM Online
- ✔ Battery powered up to 5 years (3 calls/day)
- ✔ Variety of Trigger Points
- ✔ Mobile Ready Access
- ✔ Optional LB50 Mounting Bracker

The Solution to Tough Applications Where Ultrasonic Sensors Simply DO NOT WORK!

LP100 Junction Box

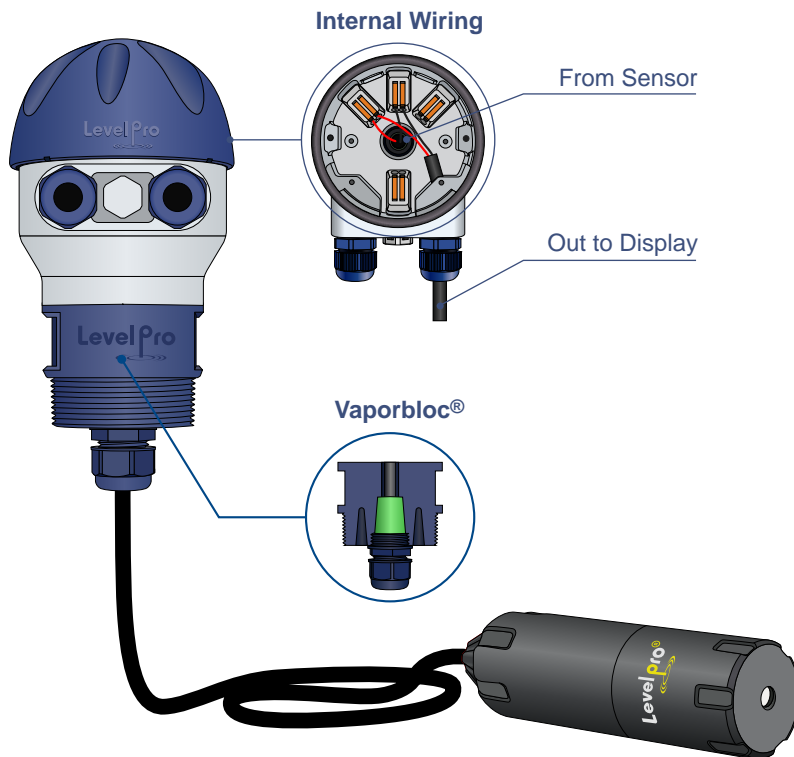

Features

- ✔ New **Vaporbloc®** Technology
- ✔ NEMA 4X Enclosure
- ✔ Tool Free Wiring Terminals
- ✔ All Plastic NEMA 4X Enclosure
- ✔ 2" Threaded Connection
- ✔ Excellent Chemical Resistance
- ✔ Weather Resistant
- ✔ **Gortex®** Air Breather Included
- ✔ Polypropylene Cord Grips
- ✔ Tethered Lid
- ✔ Lightweight Glass Filled Polypropylene
- ✔ Self-Draining Lid

Vaporbloc® Technology

- ✔ Blocks out Corrosive Chemical Fumes
- ✔ Pressure Tested to 75 psi
- ✔ Protects Internal Wiring Connections
- ✔ Eliminates Corrosive Fumes Out-gassing into Environment

The **LevelPro® 100 Series** continuous submersible level transmitter and tank level **Junction box** are a perfect pair for applications where ultrasonic sensors aren't going to work.

Accurately measure tank levels with this rugged combination that's simple to use and boasts superior chemical resistance along with industry exclusive features

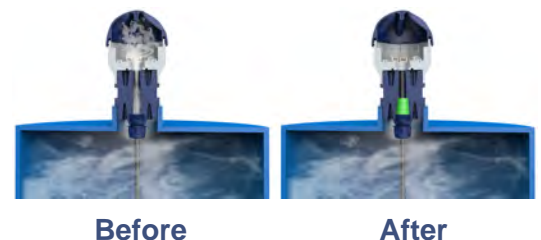

ITC-250B Series Battery Powered Level Display



Battery Operated

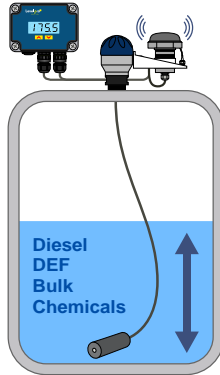

Features

- ✓ Battery Powered
- ✓ Super Bright LED Digits
- ✓ NEMA 4X Enclosure
- ✓ Security Protection
- ✓ Momentary or Adjustable Relay Timer*
- ✓ NEMA 4X Enclosure
- ✓ LED Display
- ✓ All Plastic - Corrosion Resistant
- ✓ All Cord Grips Included
- ✓ Simple Programming

TVL Series Tank Level Display & Controller



120VAC Operated

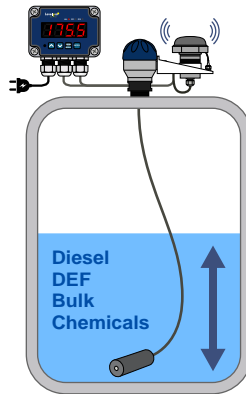

Features

- ✓ SunBright Technology for Outdoor Applications
- ✓ No Assembly Required
- ✓ 8 Levels of Brightness
- ✓ Signal Peak Value Detection | Dampens Noise
- ✓ 3 Wire Cord Grips Included | No Add Ons
- ✓ Relay Lights & Audible Alarm Function
- ✓ Completely Thermoplastic | Corrosion-Free

VU2 Series Remote Tank Level Monitoring (Dual Tank System)



220VAC Operated

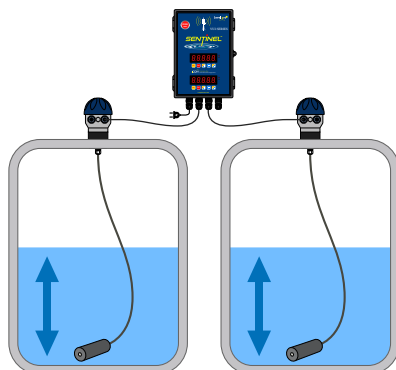

Features

- ✓ 2x LED Display
- ✓ 120VAC Powered | No Batteries
- ✓ Remote Monitoring via Cellular Networks
- ✓ 24/7 Access to Data via Cloud Based
- ✓ Low Monthly Cost
- ✓ 5-Digit LED Display
- ✓ Access Data Via PC | Laptop | Phone
- ✓ 2-5A Relays + 4-20mA Output

Technical Specifications – 100 Series Submersible Level Sensor

Input Pressure Range						
Level ft/H ₂ O		14	20	34	54	* Consult Factory for Levels > 54 Ft
Overpressure	psi	210	290	290	380	
Burst Pressure >	psi	290	580	580	720	
Output Signal Supply						
Standard		4-20mA 2-wire Hart RS 485 Voltage				
Performance						
Accuracy		<± 0.5% Full Scale or Better				
Permissible Load		$R_{max} = [(V_s - V_{smin}) / 0.02 A]$				
Influence Effects		Supply : 0.05% Full Scale Load : 0.05% Full Scale				
Long Term Stability		<± 0.1% Full Scale Over One Year				
Response Time		<10 msec				
1 Accuracy According to IEC 60770 - Limit Point Adjustment Non-Linearity Hysteresis Repeatability						
Thermal Effects Offset and Span						
Thermal Error		<± 0.2% FSO/K in Compensated Range -25 - 70°C -13 - 158° F				
Permissible Temperatures						
Permissible Temperatures		PVC 32°F - 140°F PP -4° - 178°F PVDF -30 - 178 °F Storage -10°C - 60°C				
Electrical Protection						
Short-Circuit Protection		Permanent				
Reverse Polarity Protection		No Damage to Sensor				
Electromagnetic Compatibility		Emission Immunity According to EN 61326				
Short-Circuit Protection		Permanent				
Electrical Connection						
Jacketed Cable		PTFE (Teflon®) 0 - 200°F				
3 Wire Cable with Integrated Air Tube for Atmospheric Pressure Reference						
Materials Wetted						
Housing		PVC PP PVDF				
Seals		FFKM - Kalrez®				
Diaphragm		Ceramic Al2 O3				

Technical Specifications – Sentinel Series LT

Wireless Communication	GSM Digital Wireless Radio
RF Approval	FCC part 15B Approved
Frequency Bands	GSM 850 900 MHz WLAN
Output Voltage	Nominally 14/24VDC
Output Current	4 - 20mA
Enclosure	NEMA 4X UL Approved
LAN/WAN	300ft. Line of Sight
Lithium Battery	Replaceable Lithium Ion Batteries (CR-123A)
Body Material	CPVC or PP
Operating Temperature	-13°F - 158°F -25°C - 70°C

Technical Specifications – ITC-250B Series – Battery Powered Level Display

Power Supply	2600mAh Battery Powered
Display	LED 4 x 20 mm High Red
Displayed Values	-999 - +9999
Input	Current : 4-20mA
Accuracy	0.1% @ 25°C One Digit
Stability	50 ppm °C
Operating Temp	-40 - 158°F (-40 - 70°C)
Storage Temp	-40 - 158°F (-40 - 70°C)
Protection Class	NEMA 4X IP67
Case	Wall Mounted Material - Polycarbonate
Dimensions (WxNxH)	110 x 105 x 67 mm

Technical Specifications – TVF Series – Level Process Display | Controller

Power supply	85 - 260VAC
Display	LED / 4 x 20 mm High / Red / Adjustable Brightness
Displayed Values	-999 - +9999
Input	Current : 4-20mA
Accuracy	0.1% @ 25°C One Digit
Stability	50 ppm °C
Outputs (option)	2 x Relays (5A) / 1 x Relay (5A) + 4-20mA
Passive current output (option)	4-20mA / (Operating Range Max. 2.8 - 24mA)
Operating temp	-40 - 158°F / (-40 - 70°C)
Storage temp	-40 - 158°F / (-40 - 70°C)
Protection class	NEMA 4X / IP67
Case	Wall Mounted / Material - Polycarbonate
Dimensions (WxNxH)	110 x 105 x 67 mm

Understanding Level Measurement

100 Series Submersible Level Sensor

All Submersible Sensors have a Calibrated Range that is Based on H₂O that has a Specific Gravity or Density = 1

- Range Value** : The Overall Measuring Distance that the Sensor has been calibrated to by the Factory - The Range will be Located on the Sensor Body
- Empty** : The Pressure being exerted on from the sensor diaphragm at **Lowest Point** Normally this is when the Tank is Empty within the Tank
Empty = 4mA setting.
- Full** : The Pressure being exerted on the sensor's diaphragm at the highest point Liquid Level within the Tank
Full = 20mA setting.

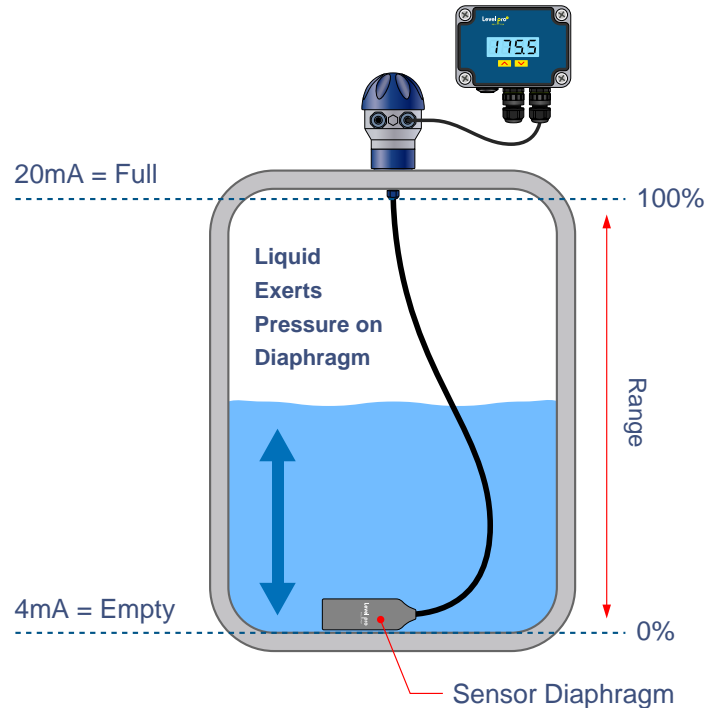

ProScan® 8000 Radar Level Sensors

- Range Value** : The Distance from the sensor's measurement point to the bottom of the Tank
- Empty Configuration** : it the distance from the sensor to the **Lowest** or **Empty Point** within the Tank
 - Empty Configuration = 4mA setting.
 - The Range and Empty Configuration values are normally the same for Flat Bottom Tanks
- Full Configuration** : The Distance from the sensor's measurement point to the **Highest Liquid Level** in the Tank
Full Configuration = 20mA setting.

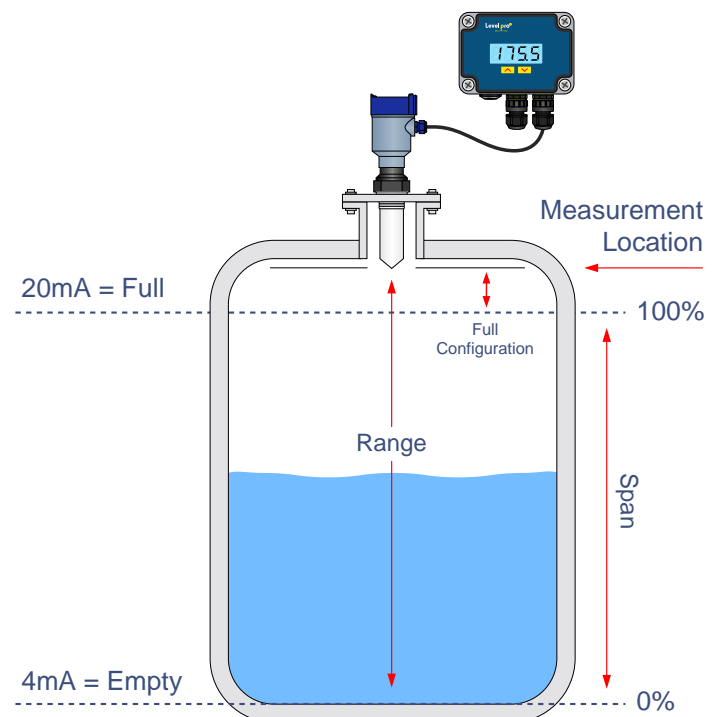

⚠ When Using Radar The Uplink Must Be Set to 60 Second Start Time.

Getting Started

- Submersible Pressure Sensors are designed to be completely submerged within the liquid. The transmitters can rest along the bottom of the tank or be suspended at any desired level within the tank.
- Please note that the physical location of the level transmitter will indicate the lowest level of measurement within the tank.

ex : Positioning the transmitter 12" from the bottom of the tank, then the lowest reading of liquid will be 12" from the bottom.

When the Liquid To Be Measured is Not H₂O the New Range of the Sensor Needs to be Determined.

To Achieve this Simply Divide the Range of the Sensor Body by the Specific Gravity of the Liquid

$$\text{SENSOR RANGE} / \text{S.G} = \text{NEW RANGE}$$

The Importance of the Liquids S.G (Specified Gravity)

The S.G of a Liquid has a Direct Effect on the Sensors Output when Measuring the Height of the Liquid

- Liquids with a S.G < 1.0 are **Lighter** than H₂O i.e. Oil
- Liquids with a S.G > 1.0 are **Heavier** than H₂O i.e. Sulfuric Acid
- H₂O has a SG = 1.0

- S.G < 1.0 Requires **More Liquid** to Equal the Same Pressure or Height as with H₂O.
- S.G > 1.0 Requires **Less Liquid** to Equal the Same Pressure or Height as with H₂O.

Here are some examples of how the submersible sensor range changes when submersed into liquids with different Specific Gravities

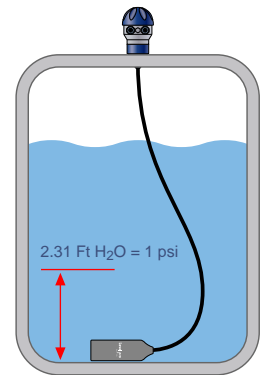
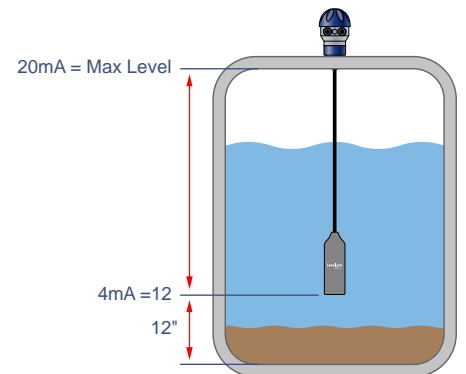
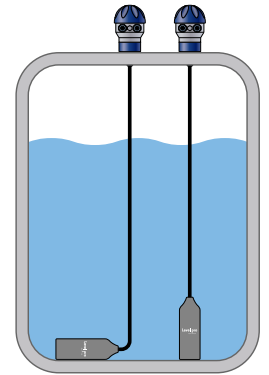
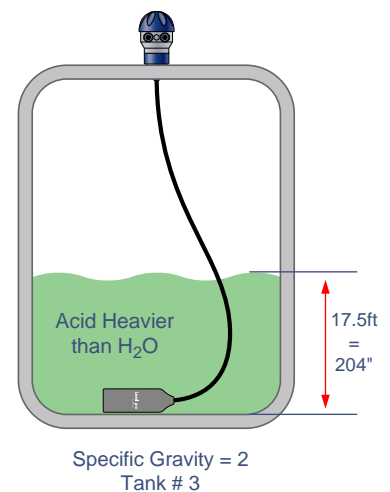
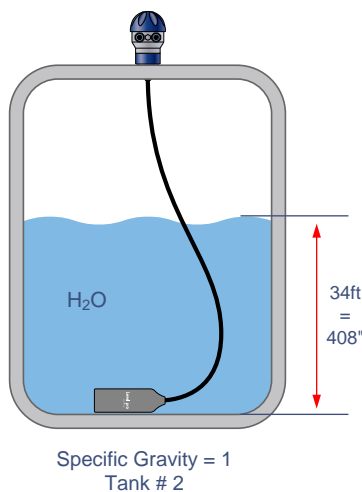
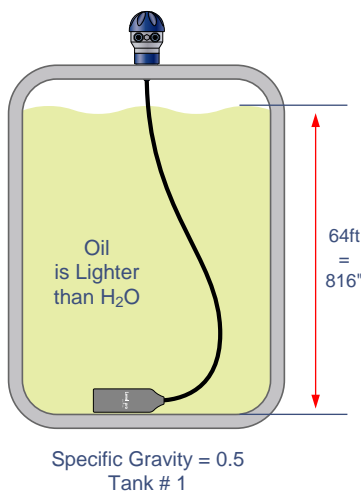

Calculating Max Range of Sensor

Lets assume a the calibrated range of the submersible sensor is 34" or 408. The range is always referenced H₂O which has a specific gravity S.G or (Density) equal to 1

Calibrated Range/S.G = Liquid Level Measurement Range $34/1 = 34'$ or $408/1 = \text{Liquid Level Range} = 408''$

Example 1

The liquid in Tank # 1 has a S.G = 0.5 which is **Lighter** than that of H₂O

To determine the New Range of the sensor simply divide the H₂O Range (34') by the S.G of the liquid that is going to be in the tank. S.G = 0.5
 $34/.5 = 64$ feet or 816 inches

Since the oil is a lighter fluid than H₂O the new measuring range of the sensor has increased and is now 64' or 816"

Example 2

The liquid in Tank # 2 has a S.G. = 2 which is **2X Heavier** than H₂O

The 34' sensor is now going to be installed into a tank to measure a liquid with a S.G = 2
 Range / S.G = New Range of the Sensor

$34/2 = 17.5$ feet or 204"

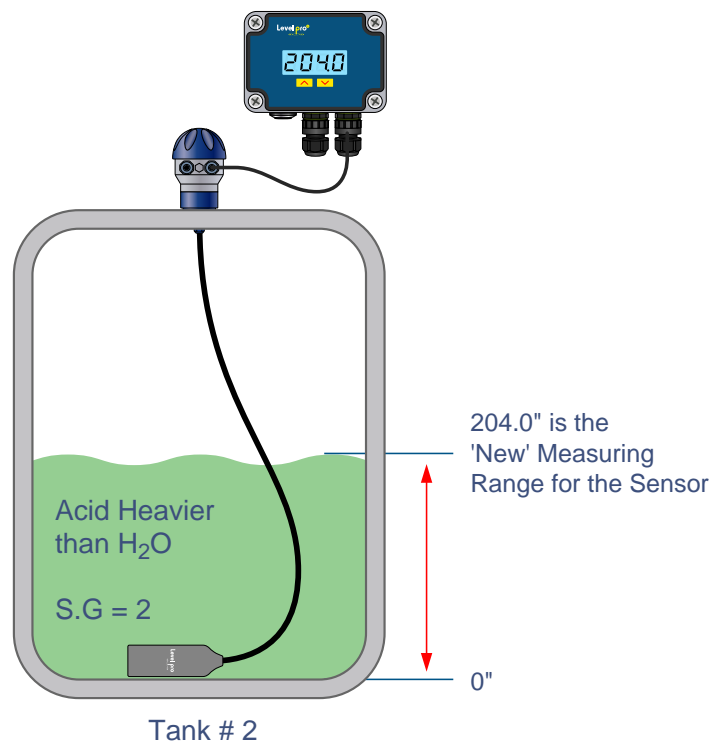
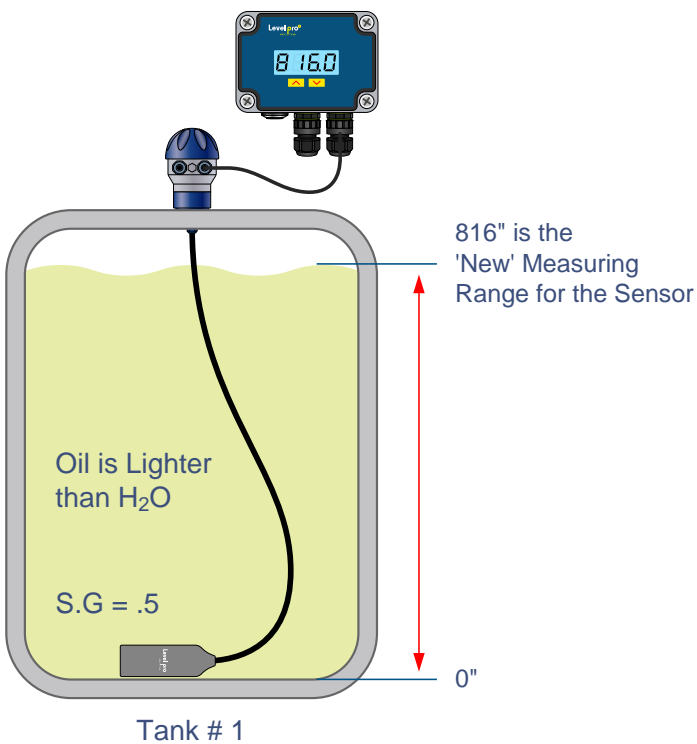

Oil S.G = 0.5	Sensor Signal	Display Reading
Tank 1 Empty	4.0mA	0"
Tank 1 Full	20.0mA	816"

Acid S.G = 2.0	Sensor Signal	Display Reading
Tank 2 Empty	4.0mA	0"
Tank 2 Full	20.0mA	204"

Correction Sensor Position

The **Submersible Level Sensor** is designed to operate while submerged in the actual application liquid. Avoid installing the level transmitter along the bottom of the tank if materials such as sludge will build up and coat/cover the transmitter. This also includes any debris that will settle along the bottom of the tank. In these applications, it is best to suspend the transmitter above the highest level of sludge/debris that will occur. See Fig A.

- ❑ **Location** : Select a location where the temperature of the transmitter will be within the specification of the sensor.



Installations where other tank requirements will cause the transmitter to move or swing.

A mixer blade could cause the level transmitter to whip around within the tank. An alternative would be to move the transmitter to a more stable section of the tank or to install the Transmitter inside a still well/drop tube. This will minimize the effects created by the mixer.

- ❑ **Position** : The transmitter is not position sensitive.
- ❑ **Mounting** : The transmitter can be mounted via several methods. It can be suspended from the cable, it can be placed resting on the bottom of the tank in either horizontal or vertical orientation, or it can be attached to a pipe or hardwired using the **LP100** conduit box on the top of the housing.

- ❑ **Avoid** : installations where other tank requirements will cause the transmitter to move or swing.
Ex: A mixer blade could cause the level transmitter to whip around within the tank. An alternative would be to move the transmitter to a more stable section of the tank or to install the Transmitter inside a still well/drop tube. This will minimize the effects created by the mixer.

Termination: The cable for the transmitter is terminated at a LP100 junction box located on top of the tank. Since the vent tube is contained within the cable, the pressure within the junction box. A Gortex® Breather to ensure accurate atmospheric pressure inside the junction which is necessary as a reference to the pressure acting on the sensor at the bottom of the tank.

The inside of the function box must be clean, dry and free of moisture.

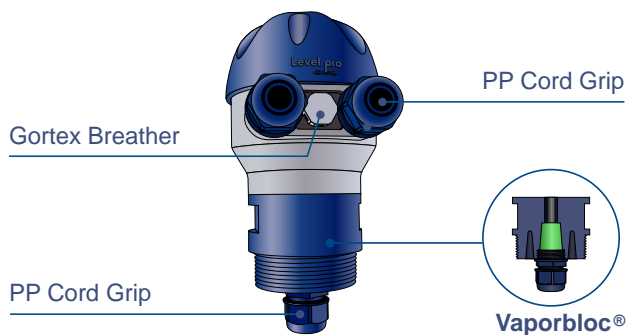
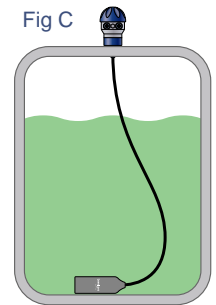
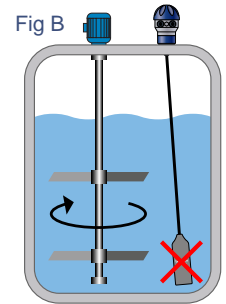
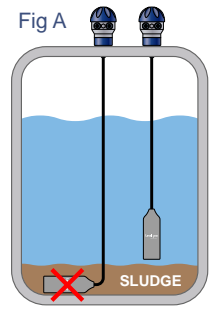

- ❑ **Note:** Use caution when connecting the cable within the junction box. A ventilation/reference tube is located within the cable. The purpose of this tube is to provide a comparison between current atmospheric pressure and the pressure that is being exerted on the sensing diaphragm within the tank.
- ❑ The reference tube must be open and free to allow air to flow back to the pressure diaphragm.
- ❑ Avoid blocking or bending the ventilation tube by compressing the cable.

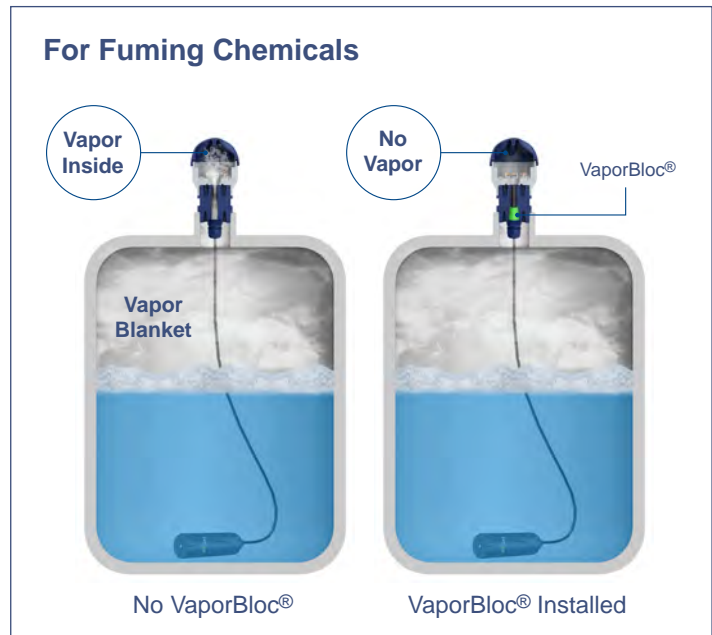

Sensor & Junction Box Installation

01

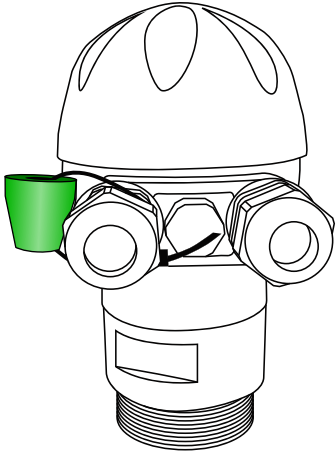

02

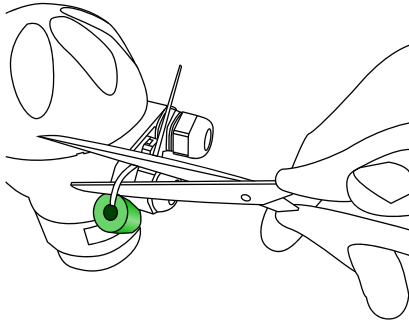

Cut Zip Tie to Retrieve VaporBloc®

03

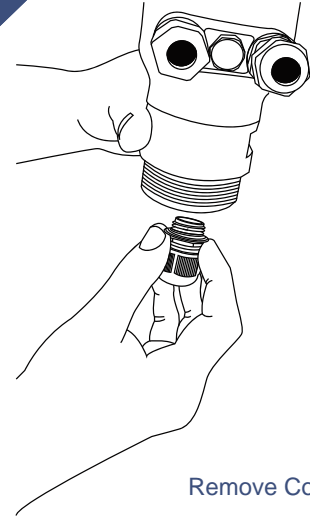

Remove Cord Grip

04

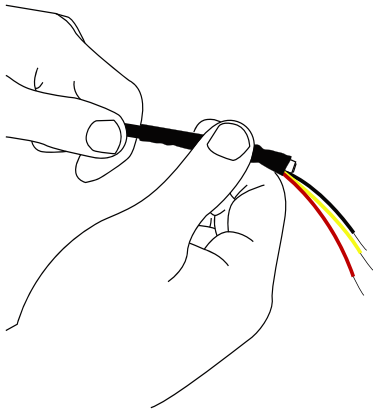

Remove Heat Shrink

05

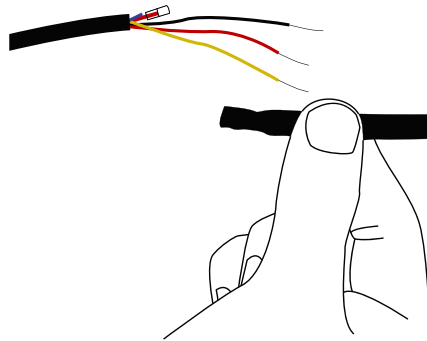

Discard Heat Shrink

06

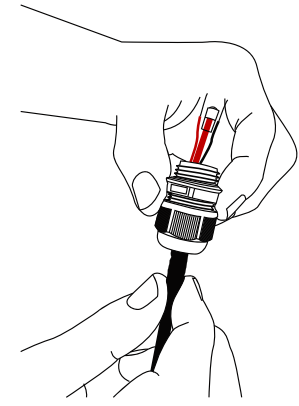

Push Wires & Breather Through Cable Gland

07

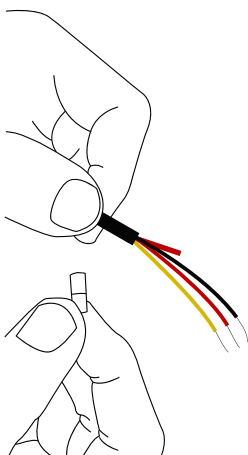

Remove Filter from Vent Tube

08

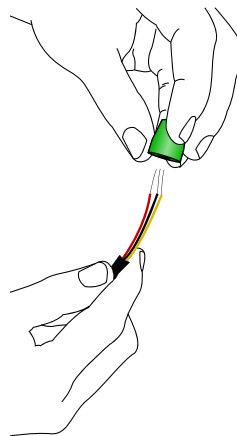

Feed Wires through VaporBloc®

09

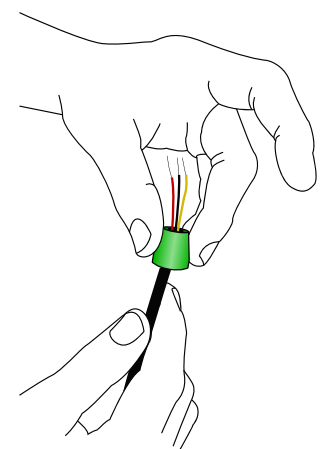

Ensure VaporBloc® is Oriented Correctly

<p>10</p> <p>Ensure VaporBloc® has a Snug Fit</p>	<p>11</p> <p>Place Filter back on Vent Tube</p>	<p>12</p> <p>Insert Wire into the Junction Box</p>
<p>13</p> <p>Ensure Cable is fully Inserted</p>	<p>14</p> <p>Thread Cord Grip Into Junction Box</p>	<p>15</p> <p>VaporBloc® Installed</p>

Sensor & Junction Box Wire Connection

<p>01</p> <p>1/4 Turn</p> <p>Level pro</p> <p>Take Junction Box Open Lid</p>	<p>02</p> <p>Lid is Tethered</p> <p>Level pro</p> <p>⚠ Fuming Liquids??? Please Install VaporBloc®</p> <p>Open Lid</p>	<p>03</p> <p>Sensor Cable</p> <p>⚠ Do Not Bend Capillary Reference Tube</p> <ol style="list-style-type: none"> 1. Feed Sensor Red and Black Wire + Breather into Junction Box 2. Tighten Cord Grip
--	--	--

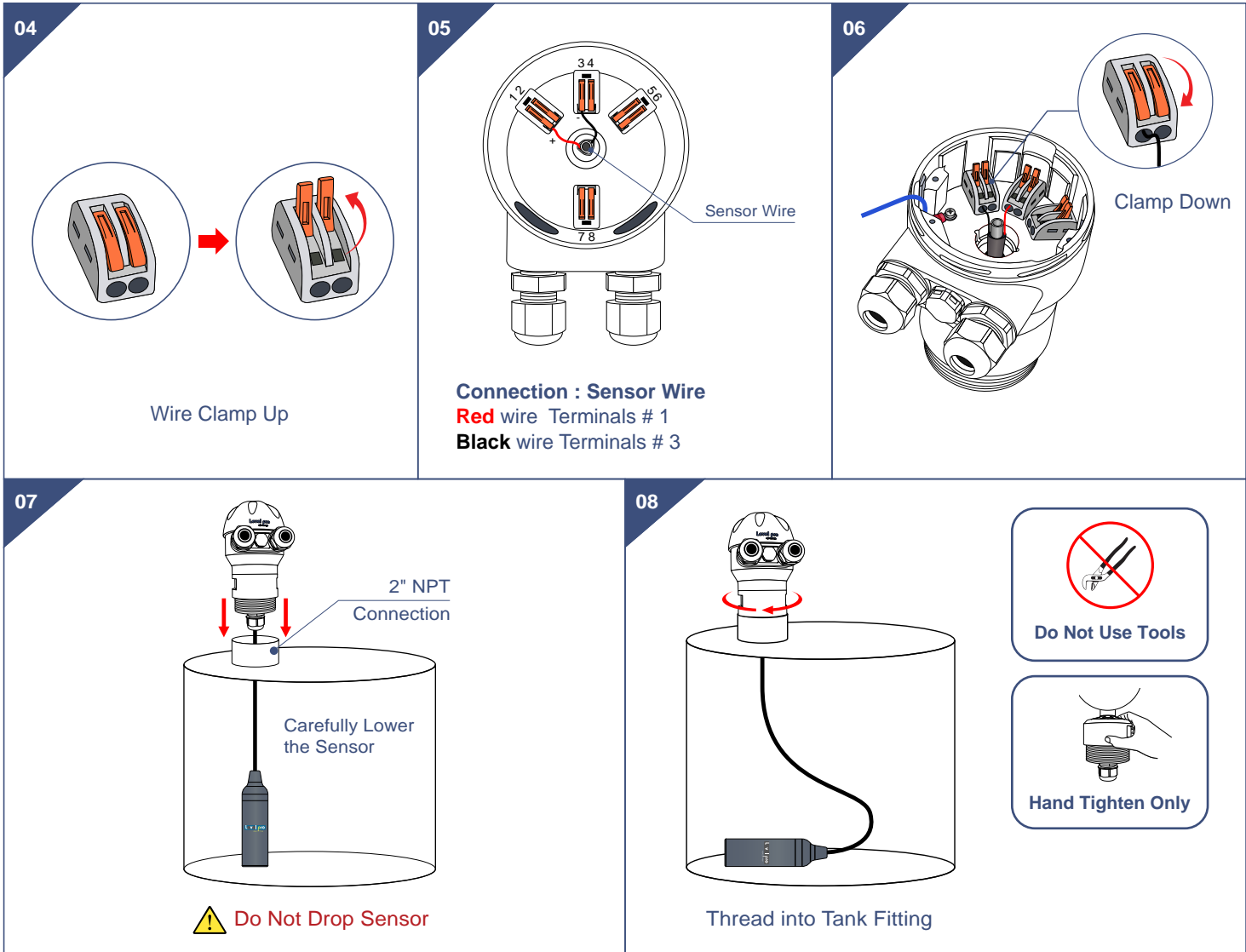

Sentinel LT Install & Wire Connection

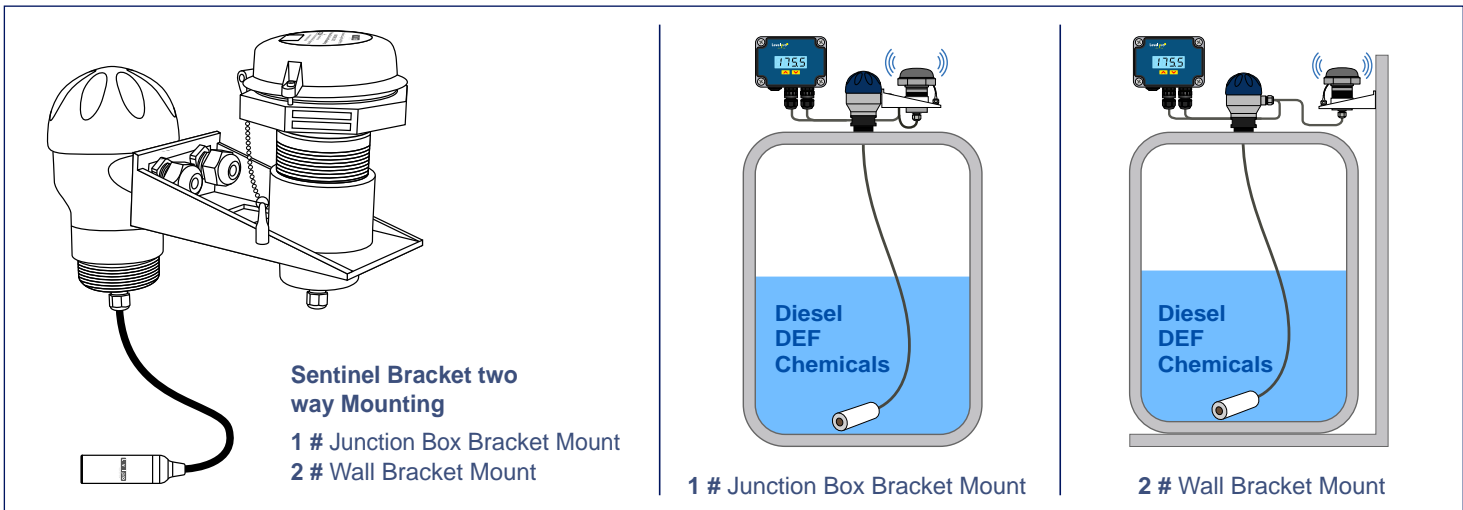

ITC-250B Display Wire Connection to Junction Box

01

ITC-250B Display

Display Connection to Junction Box

Green wire Terminal 8 Left Display Port

Orange Wire Terminal 6 Right Display Port

Red wire Terminal 2

Black Wire Terminal 4

02

ITC-250B Display

Connection to Junction Box

Green wire Terminal 8

Orange Wire Terminal 6

Red wire Terminal 2

Black Wire Terminal 4

03

Closed Junction Box Lid

ITC-250B Display Wire Connection

01

Turn Cable Grip Nut Counter-Clockwise

02

Remove Nut and Cable Grip

03

Insert Wire in Cable Grip Nut

04

Left Port for Uplink Right Port for Sensor

Green to 'N' Terminal **Black** to 'N' Terminal

Orange to 'L' Terminal **Red** to 'L' Terminal

Sentinel Uplink Sensor

05

Insert Wire Uplink & Sensor and Tighten Terminal Screw

06

Press Button to Test Hand Tighted Cable Grip

Wiring Diagram - Sentinel + Junction Box + Sensor

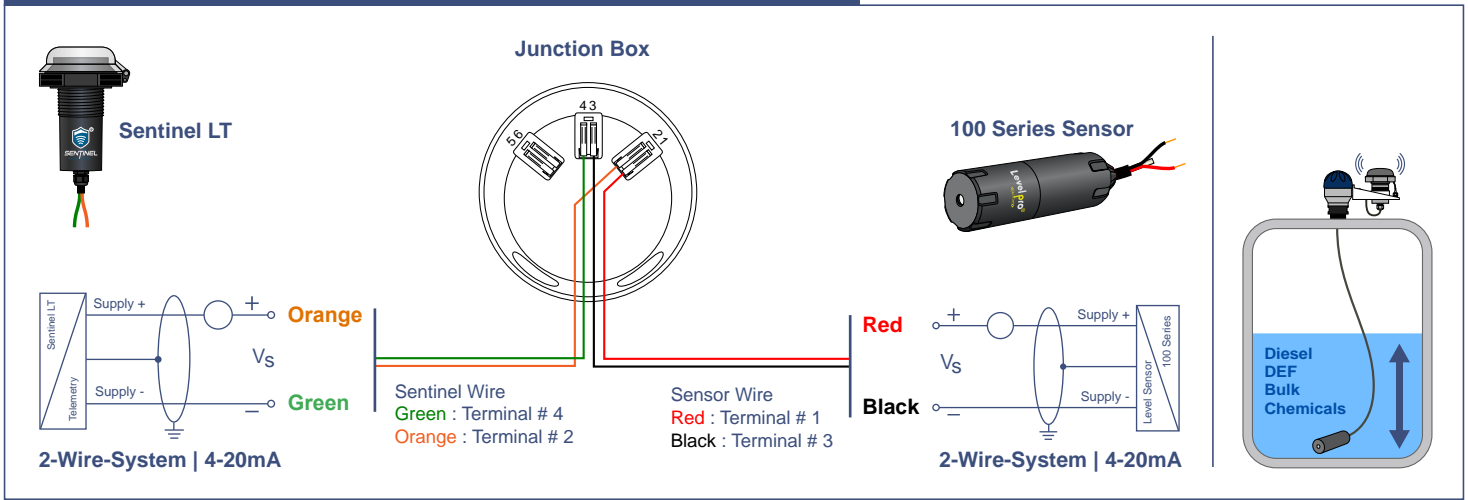

Wiring Diagram - Sentinel + Junction Box + Sensor + 250B Display

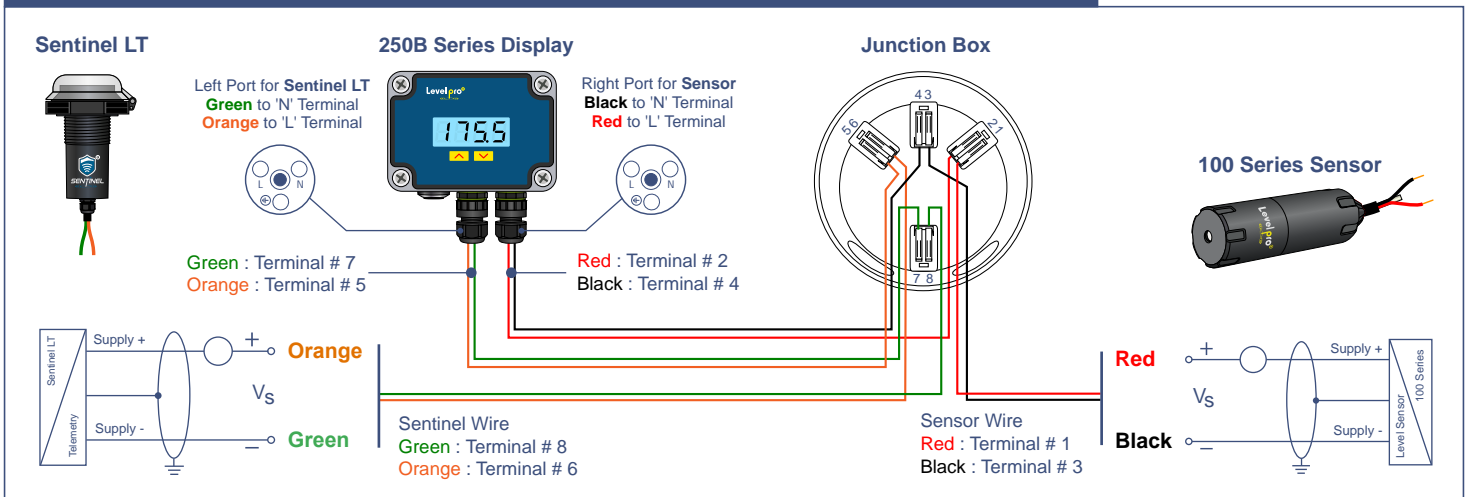

Wiring Diagram - Sentinel + Sensor + 250B Display

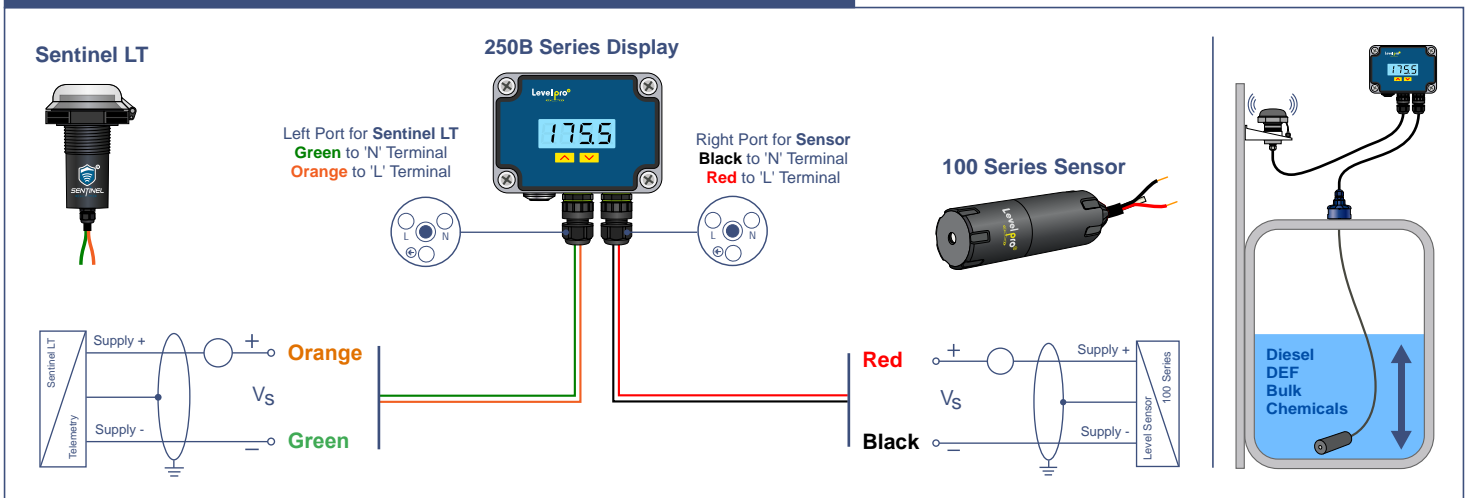

Wiring Diagram - Sentinel + Junction Box + Sensor + TVL Display

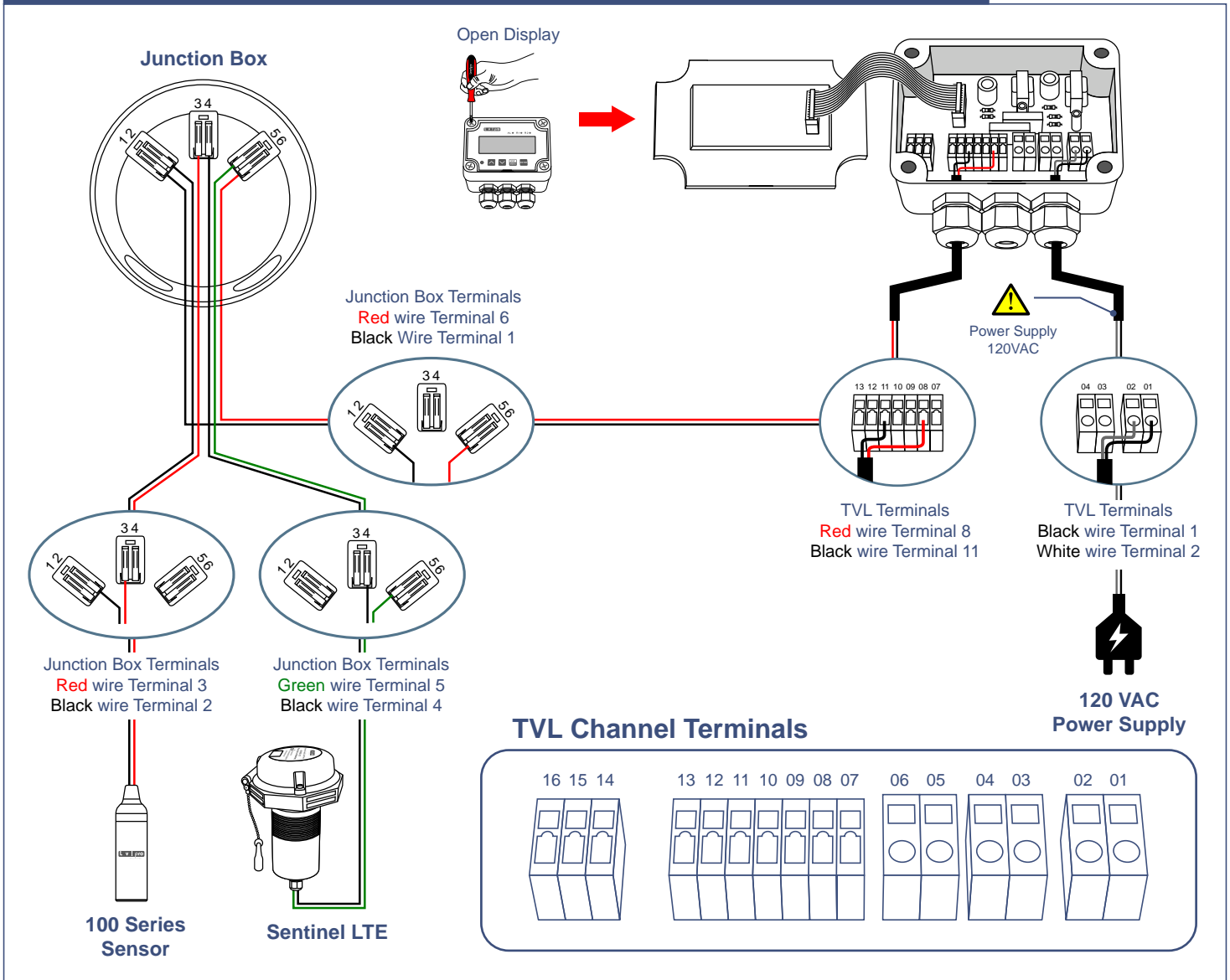

Wire Connection in TVL Channel Terminals

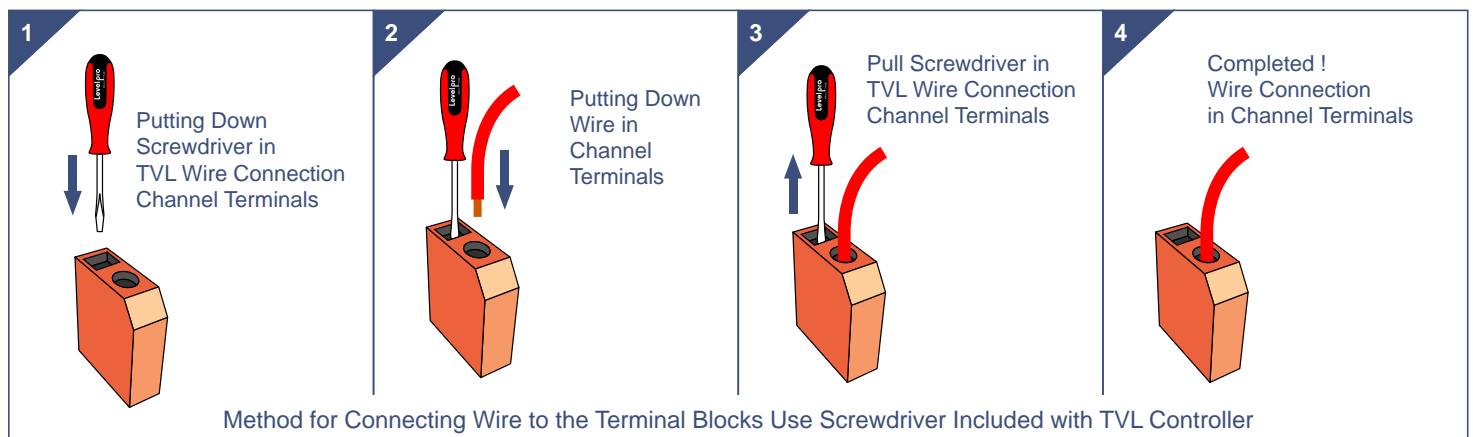

Wiring Diagram - Sentinel VU + Junction Box + Sensor

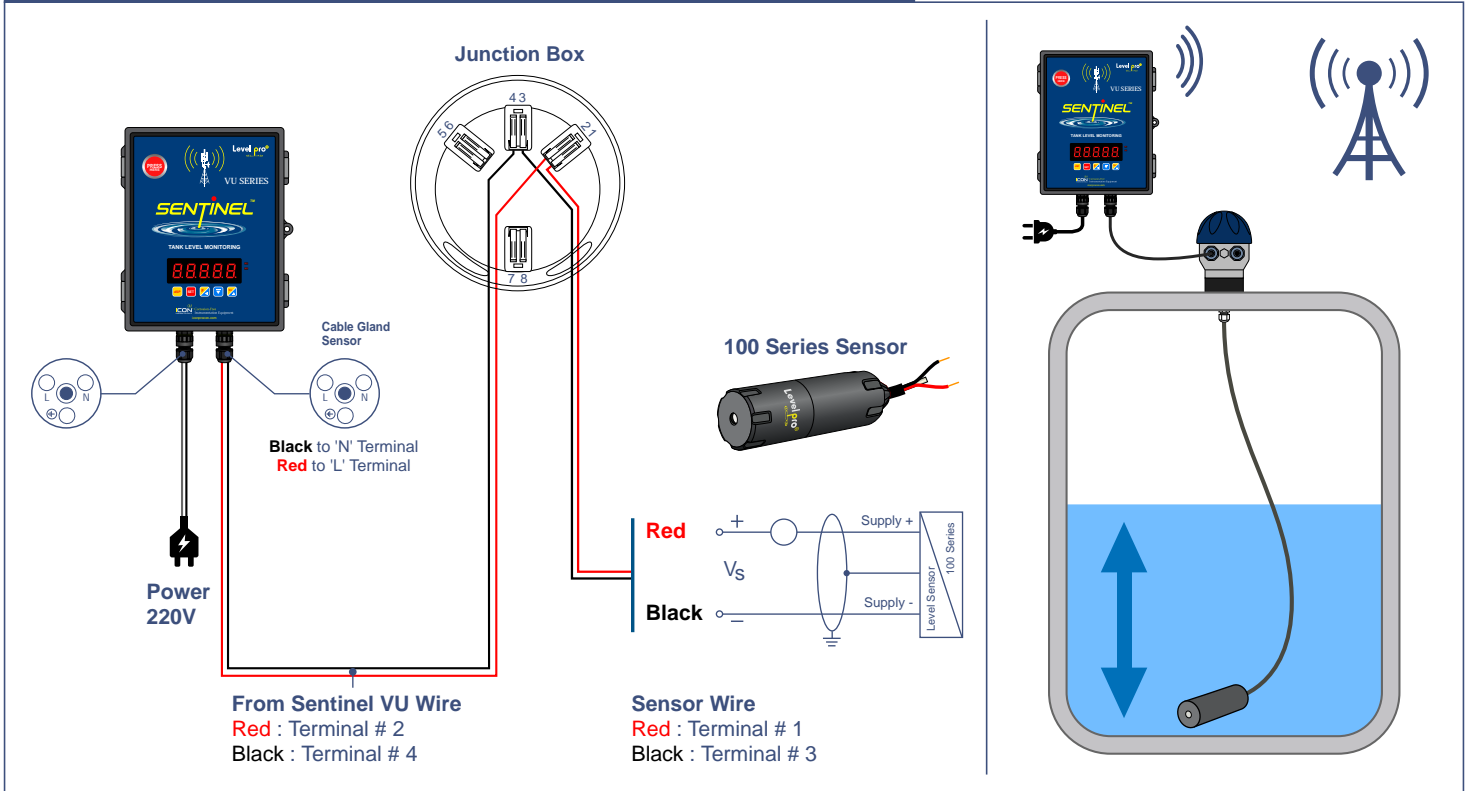

Wiring Diagram - Sentinel VU2 + Junction Box + Sensor (Dual Tank System)

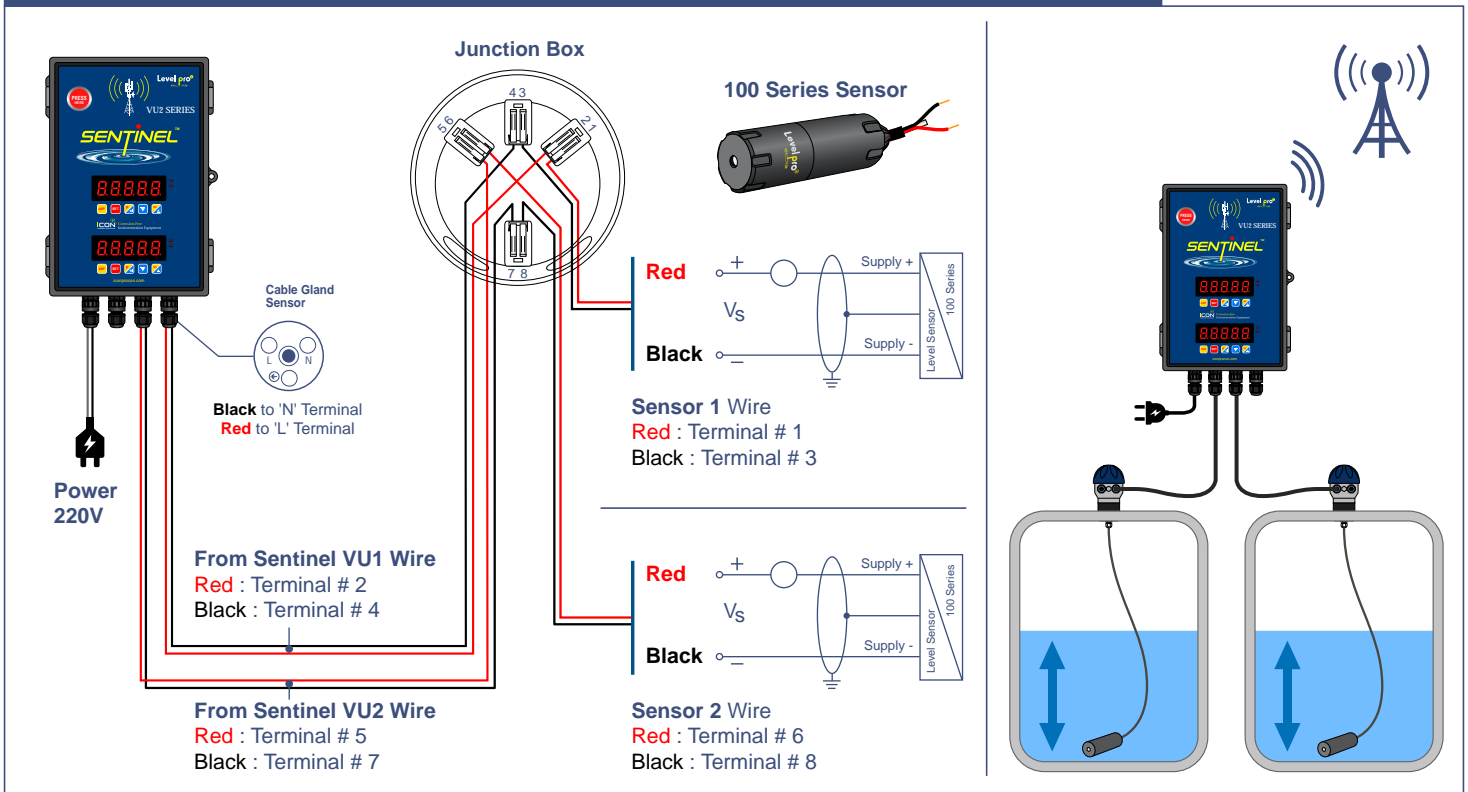

Programming Display

STEPS	DISPLAY	OPERATION	
#1 Press Buttons Together Press (HOLD 3 sec)		Press and Hold Both Buttons to Enter the Menu	<p>4mA Empty</p>
#2 Release Buttons		Enter Pass Code 1234 } Move to Next Step	
#3 Press Up Button 4X Press		Using the UP Arrow, Press 4X Times until the Password Reads '1234' Click Both Buttons at the Same Time to Proceed into the menu	
#4 Press Buttons Together Press (HOLD 3 sec)		Decimal Point - Default = 0	<p>20mA Full</p> <p>4mA Empty</p>
#5 Press to Change Press		Default = 0 0 decimal places 2 Decimal Places 1 decimal place 3 Decimal Places	
#6 Press Buttons Together Press (HOLD 3 sec)		Enter Low Level Range- 4mA Default = 0	
#7 Change to Desired Value Press Key		4mA = Empty Level Value of the Sensor Inches Feet Gallons Refer to Reference Picture	<p>20mA Full</p> <p>12mA = 1/2 Full</p> <p>4mA Empty</p>
#8 Press Buttons Together Press (HOLD 3 sec)		20mA = Full Level Value Default = 100 Refer to Reference Picture	
#9 Change to Desired Value Press Key		20mA = High Level Value Inches, Feet, Gallons Displaying Inches of Liquid Sensor Range / S.G i.e. Max R / S.G = 34' / S.G = Inches of Liquid Displaying Gallons Sensor Range / S.G x Gal / Inch (Based On Tank Capacity) = Gallons of Liquid	
#10 Current Level Press (HOLD 3 sec)		Display Indicates Current Tank Level Value	

Press both buttons to Save High Level Value

www.iconprocon.com | sales@iconprocon.com | 905.469.9283

Push Button Call-Out

⚠ ENSURE DISPLAY IS OFF BEFORE INITATING CALL-OUT

<p>01</p> <p>Loosen Screws</p> <p>Ensure Display is off</p>	<p>02</p> <p>Open Lid</p>	<p>03</p> <p>Press the Button - Power On</p>
<p>04</p> <p>Slow Green Light Flashes</p>	<p>05</p> <p>Green + Red LED's Flashes Alternately</p>	<p>06</p> <p>Green LED will go steady on</p>
<p>07</p> <p>Closed Lid</p>	<p>08</p> <p>Visual Light on Lid</p>	<p>09</p> <p>Tighten Srews</p>

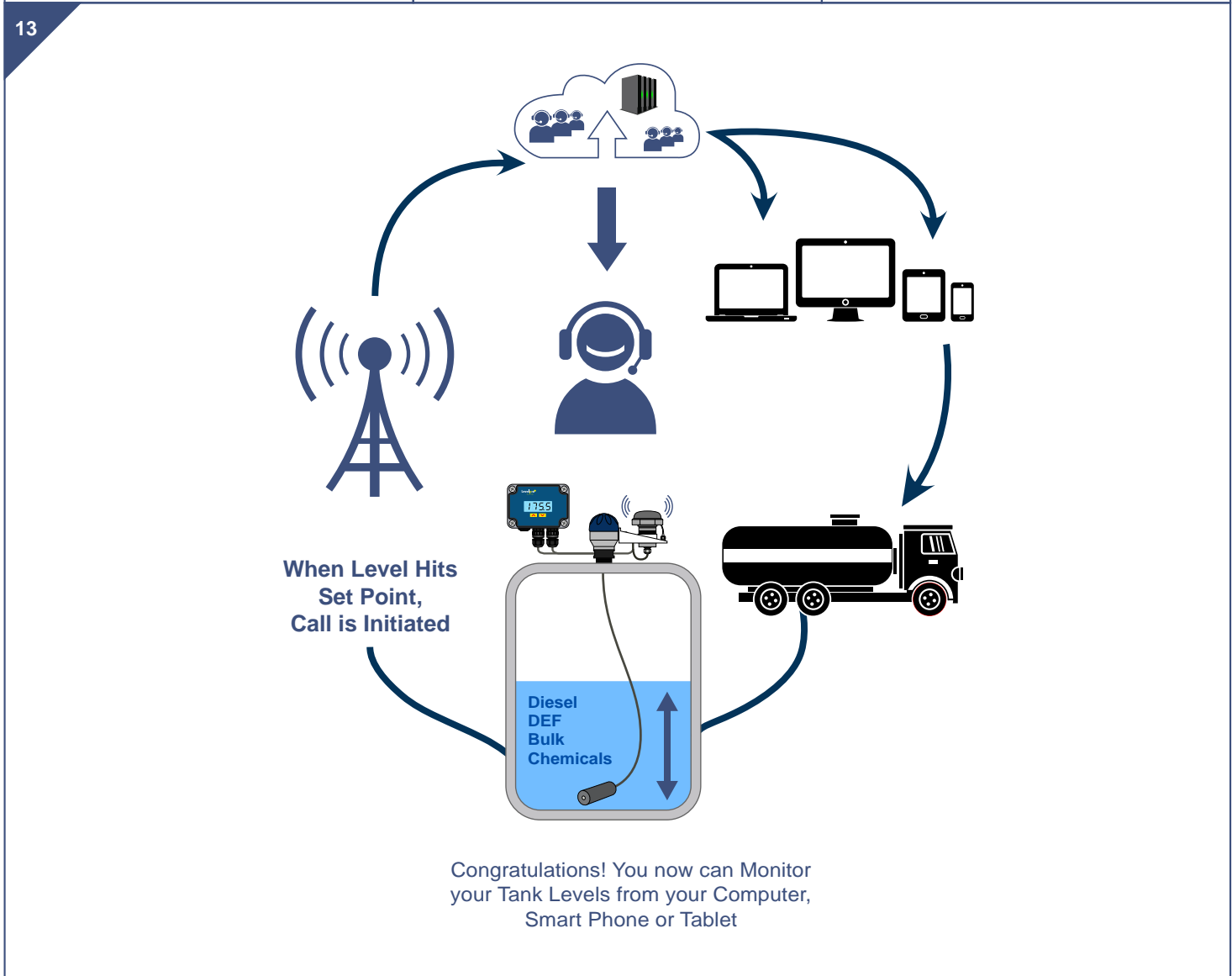
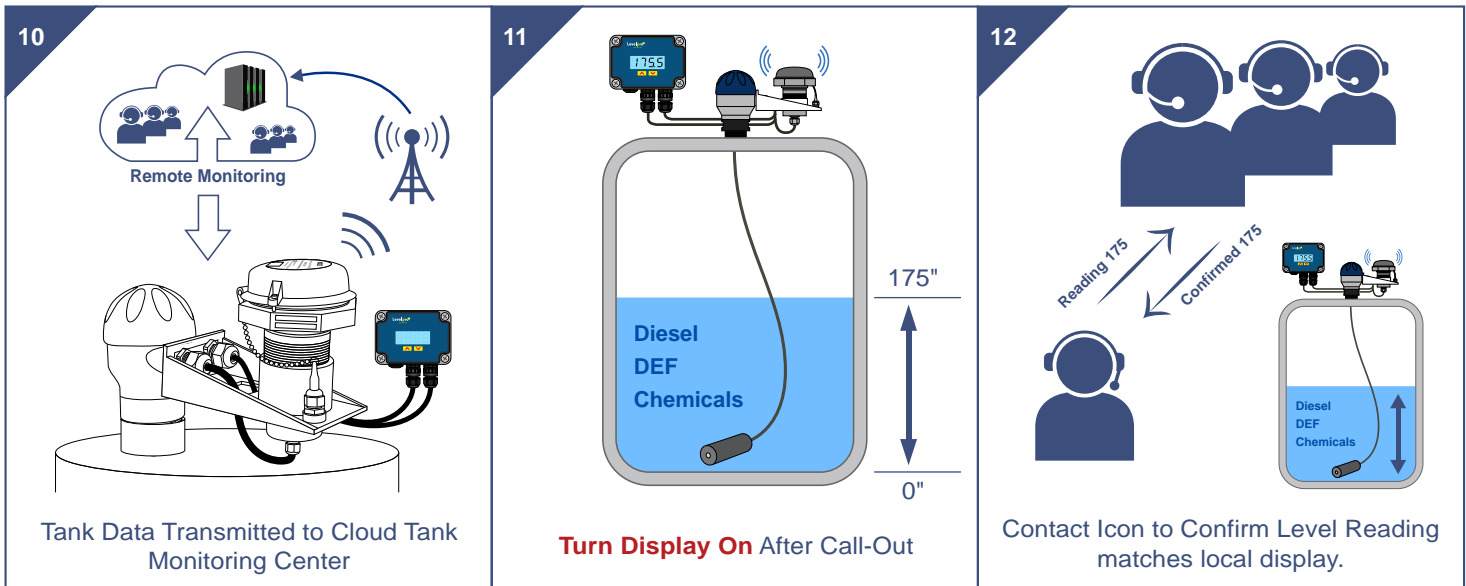

Magnetic Call-Out

⚠️ ENSURE DISPLAY IS OFF BEFORE INITATING CALL-OUT

01

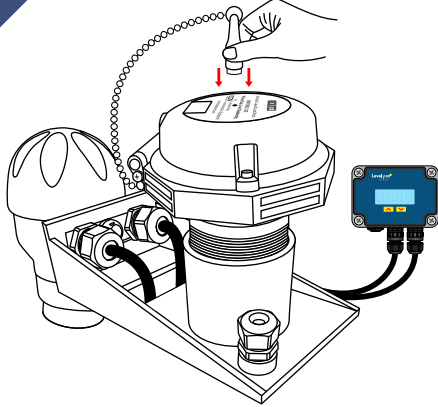

To Initiate the Call Out Place the Magnet Against the Lid

02

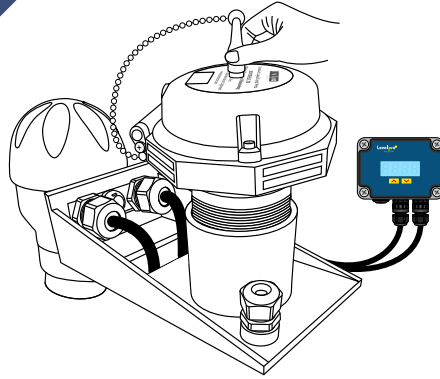

Hold the Magnet in Place for One (1) Second

03

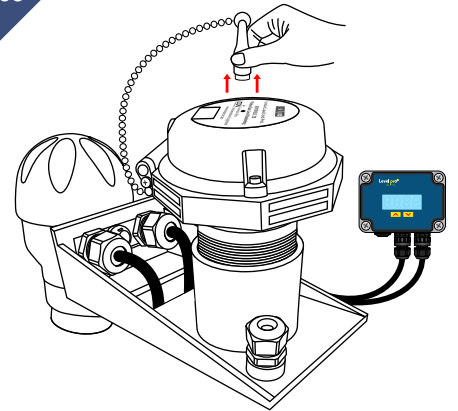

Lift Magnet

04

Call Out Sequence is Initiated

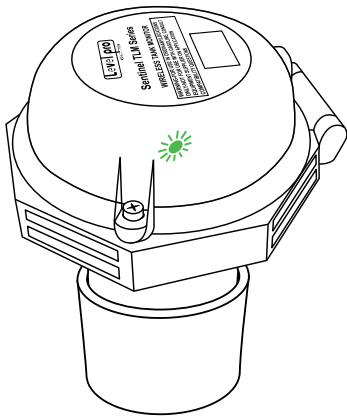

Slow Green LED Flashes

05

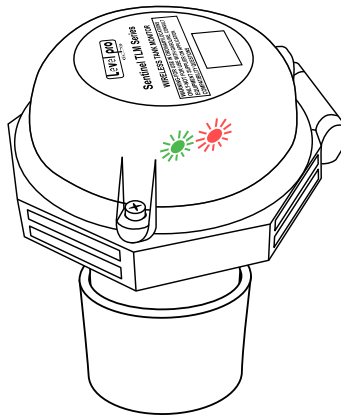

Green & Red LED Alternating Flashes

06

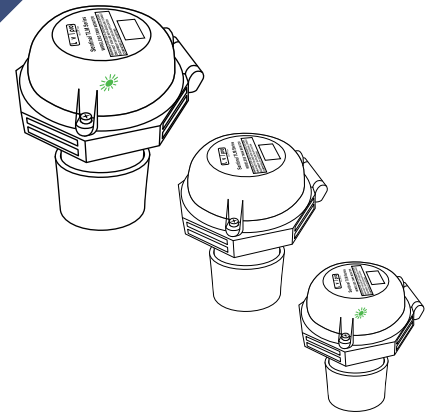

Green LED will go steady Green Light Flashes and Goes Out

07

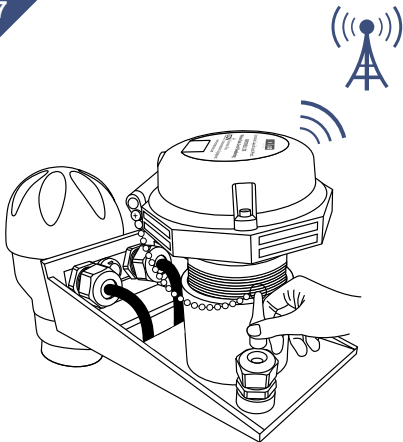

Place Magnet into Holder for Safe Keeping

08

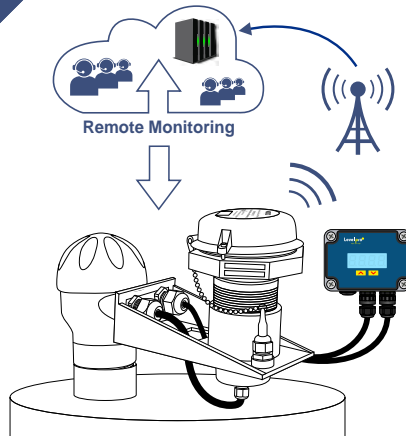

Tank Data is Transmitted to Cloud Tank Monitoring Center

09

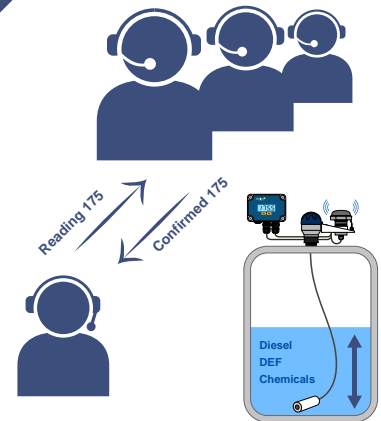

Contact Icon to Confirm Level Reading matches local display.

Battery Replacement

01

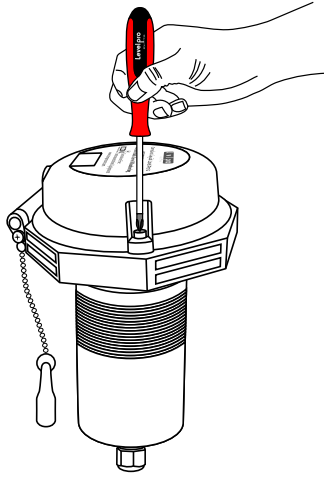

Remove Screws Open Lid

02

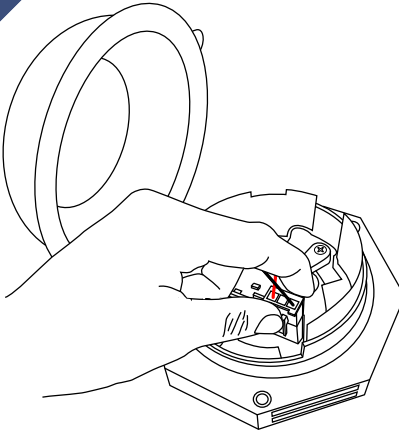

Press On Connector with 2 Fingers

03

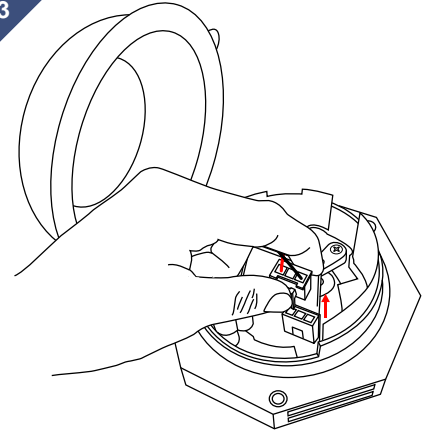

Gently Pull Connector Upwards

04

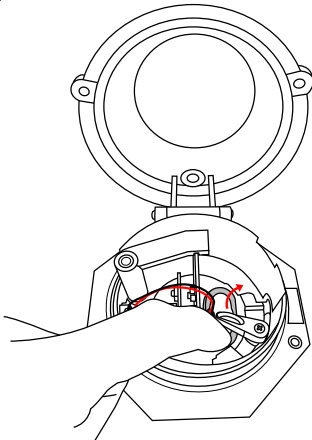

Gently Slide Retainer Clockwise

05

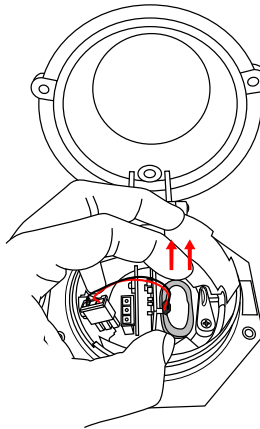

Gently Pull Up on Battery

06

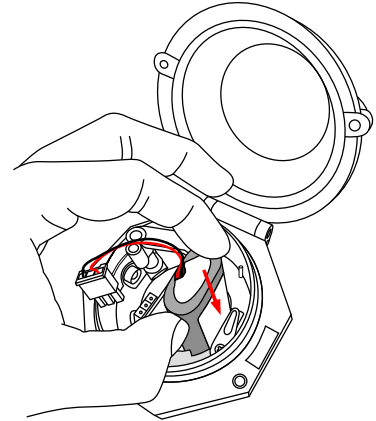

Insert New Battery

07

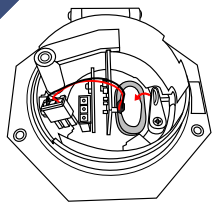

Slide Retainer
Counter
Clockwise

Reconnect Plug

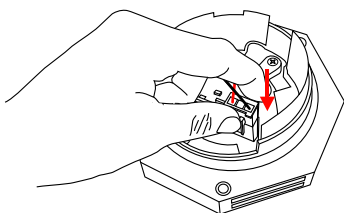

08

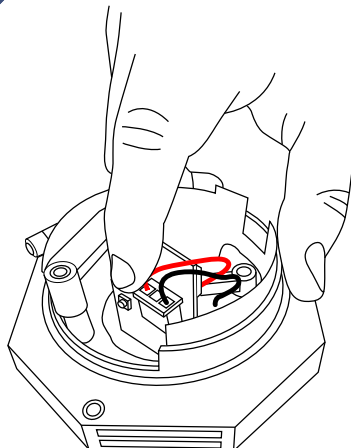

Push Button to Initiate Call Out

09

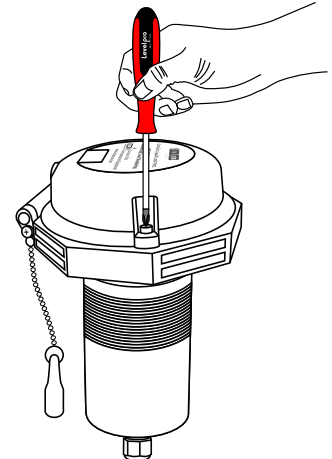

Close Lid

Application Details

- Chemical _____
- Concentration _____
- Specific Gravity _____
- Temperature _____
- Solids : Yes No
- Out-gassing or Vapors : Yes No
- Tank Dimensions W x H inches :
W = _____ H = _____
- Vertical : Horizontal :
- Flat Bottom : Conical Bottom :

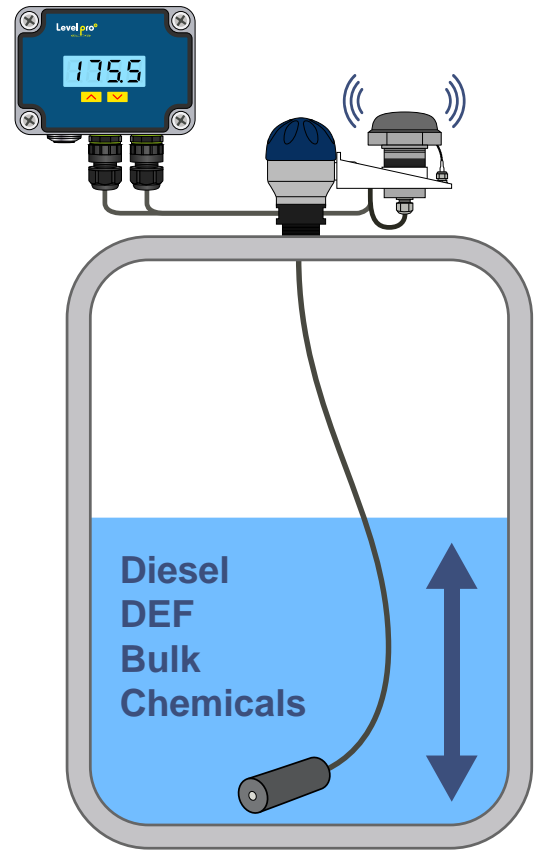

Troubleshooting

Invalid Data



Ensure Display is **OFF** when Initiating Uplink Call- Out

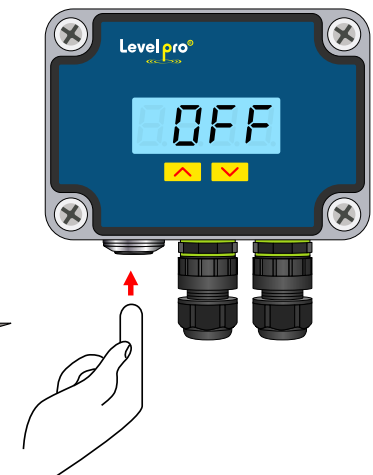
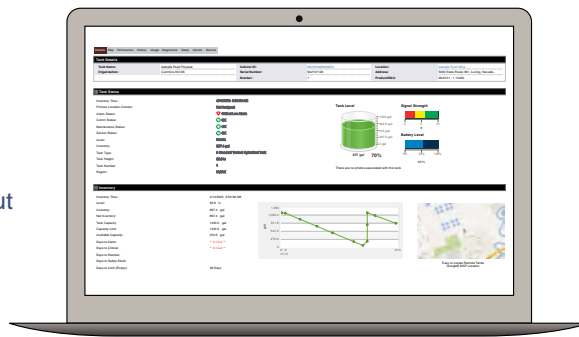

Trouble Shooting the Sensor

1. First, verify that the sensor is wired correctly.
2. Next, check if the power supply is providing the required power.

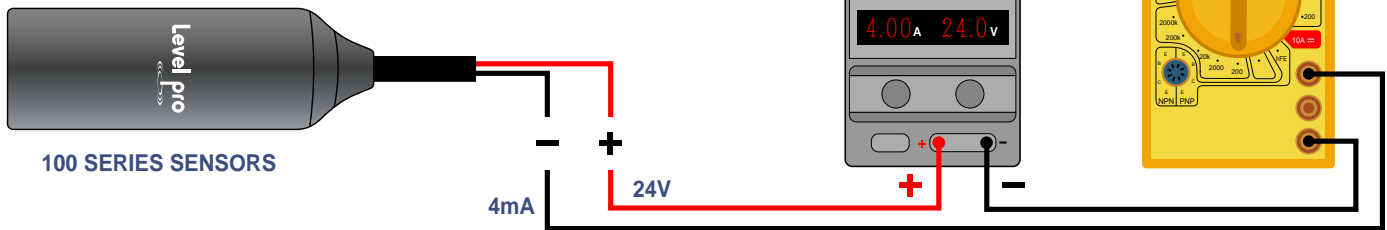

If transmitter is not functioning properly, isolate the transmitter from the system and wire as shown below. Be sure to remove the sensor from the classified area when performing this test. Multi Meter should read 4 mA with the transmitter out of liquid.

Display Not Turning On

- Check Wiring
- Check Battery Status

Invalid Data Transfer

- Ensure Display is **OFF** when making Call-Out
- Check Battery Status

Display Indicates LL

- Check Wiring
- Check Battery Status

Incorrect Display Reading

- The reference or capillary tube is fitted with a **Gortex®** Filter - this must remain attached in order to prevent moisture, particulate or insects from entering. Do Not Remove.
- Avoid blocking or bending the ventilation tube.
- The LP100 Installation Junction Box is fitted with a **Gortex®** Breather to allow for air to pass but not water. Please Ensure this Not Blocked

Measuring Liquids that Fume, Form Vapor Blankets or Out-Gas - Ensure Vaporbloc® has Been Installed

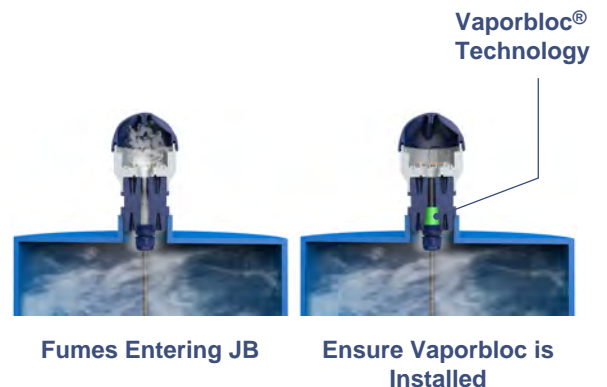
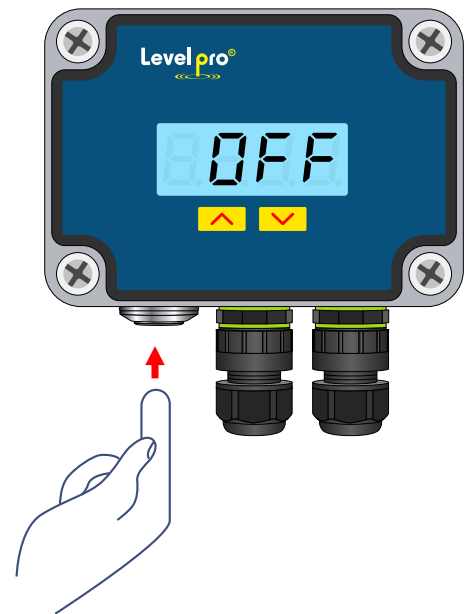

- Always keep the cable termination clean, dry and free of moisture and prevent liquid from entering the vent tube
- Confirm Programming Input for 20mA (d IH on Display) is Correct
- Confirm Specific Gravity of Liquid is Correct.

Determine 20mA Value to Program d IH on Display

Example : S.G of the Liquid is Heavier than H₂O

The Submersible Sensor Range is 34' is now going to be installed into a tank of Acid

S.G = 2 : Sensor Range = 0-34'

To Calculate the New Range of the Sensor = Range/S.G | 34/2 = 17.5 ft or 204 inches
 The liquid is Heavier than H₂O so the Overall Sensor Range Has been reduced to 14.5 ft or 204 inches The 204 is Entered

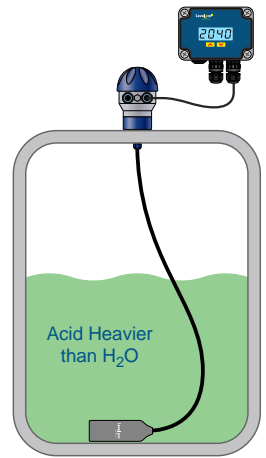

20mA = Full Level Value
 Default = 100 | Refer to Reference Picture

20mA = the High Tank Level Value of the Sensor. Inches | Feet | Gallons



*This number is determined by dividing the max range of the sensor by the Specific Gravity

Display Inches
 Range / S.G = 34' / S.G = New Full Range of Sensor | 20mA

Display Gallons
 Range / S.G x Gal/Inch = Gallons



20mA = Full

Range

4mA = Empty

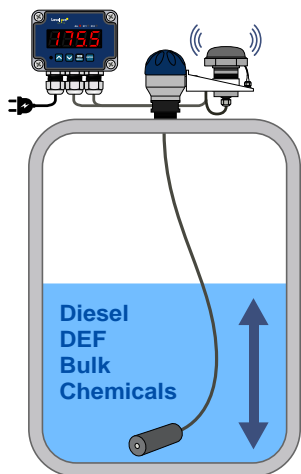
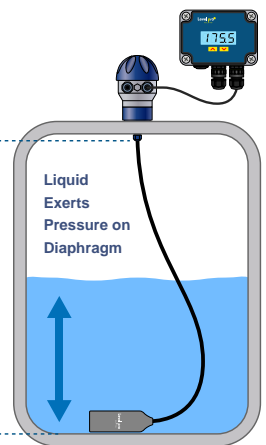

TANK | SUMP SENTINEL



Cellular Network



Sentinel 24/7 Online



Inventory Manager

Warranty, Returns & Limitations

Warranty

Icon Process Controls Ltd warrants to the original purchaser of its products that such products will be free from defects in material and workmanship under normal use and service in accordance with instructions furnished by Icon Process Controls Ltd for a period of one year from the date of sale of such products. **Icon Process Controls Ltd** obligation under this warranty is solely and exclusively limited to the repair or replacement, at **Icon Process Controls Ltd** option, of the products or components, which **Icon Process Controls Ltd** examination determines to its satisfaction to be defective in material or workmanship within the warranty period. Icon Process Controls Ltd must be notified pursuant to the instructions below of any claim under this warranty within thirty (30) days of any claimed lack of conformity of the product. Any product repaired under this warranty will be warranted only for the remainder of the original warranty period. Any product provided as a replacement under this warranty will be warranted for the one year from the date of replacement.

Returns

Products cannot be returned to **Icon Process Controls Ltd** without prior authorization. To return a product that is thought to be defective, go to www.iconprocon.com, and submit a customer return (MRA) request form and follow the instructions therein. All warranty and non-warranty product returns to **Icon Process Controls Ltd** must be shipped prepaid and insured. **Icon Process Controls Ltd** will not be responsible for any products lost or damaged in shipment.

Limitations

This warranty does not apply to products which: 1) are beyond the warranty period or are products for which the original purchaser does not follow the warranty procedures outlined above; 2) have been subjected to electrical, mechanical or chemical damage due to improper, accidental or negligent use; 3) have been modified or altered; 4) anyone other than service personnel authorized by Icon Process Controls Ltd have attempted to repair; 5) have been involved in accidents or natural disasters; or 6) are damaged during return shipment to **Icon Process Controls Ltd** reserves the right to unilaterally waive this warranty and dispose of any product returned to **Icon Process Controls Ltd** where: 1) there is evidence of a potentially hazardous material present with the product; or 2) the product has remained unclaimed at Icon Process Controls Ltd for more than 30 days after Icon Process Controls Ltd has dutifully requested disposition. This warranty contains the sole express warranty made by **Icon Process Controls Ltd** in connection with its products. **ALL IMPLIED WARRANTIES, INCLUDING WITHOUT LIMITATION, THE WARRANTIES OF MERCHANTABILITY AND FITNESS FOR A PARTICULAR PURPOSE, ARE EXPRESSLY DISCLAIMED.** The remedies of repair or replacement as stated above are the exclusive remedies for the breach of this warranty. **IN NO EVENT SHALL Icon Process Controls Ltd BE LIABLE FOR ANY INCIDENTAL OR CONSEQUENTIAL DAMAGES OF ANY KIND INCLUDING PERSONAL OR REAL PROPERTY OR FOR INJURY TO ANY PERSON. THIS WARRANTY CONSTITUTES THE FINAL, COMPLETE AND EXCLUSIVE STATEMENT OF WARRANTY TERMS AND NO PERSON IS AUTHORIZED TO MAKE ANY OTHER WARRANTIES OR REPRESENTATIONS ON BEHALF OF Icon Process Controls Ltd.** This warranty will be interpreted pursuant to the laws of the province of Ontario, Canada.

If any portion of this warranty is held to be invalid or unenforceable for any reason, such finding will not invalidate any other provision of this warranty

For additional product documentation and technical support visit www.iconprocon.com | e-mail: sales@iconprocon.com | support@iconprocon.com | Ph: 905.469.9283



Corrosion-Free
Instrumentation Equipment